

चित्र: ८. टंग और क्लेविज टाइप विद्युतरोधक के लिए ११ के. वी. विकृति क्लैम्प

FIG. 8. 11 KV. STRAIN CLAMP FOR TONGUE AND CLÉVIS TYPE INSULATOR.

ALL DIMENSIONS ARE IN mm.

---

## **21. Porcelain Insulators and Insulator Fittings for 33 kV Overhead Power Lines**

### **1. SCOPE**

This specification covers the details of the porcelain insulators and insulator fittings for use on 33 KV lines in rural electric sub-transmission systems.

### **2. APPLICABLE STANDARDS**

Unless otherwise stipulated in this Specification, the insulators shall comply with the Indian Standard Specification **IS:731-1971** and the insulator fittings with **IS:2486 (Pt.I)-1971** and **IS:2486 (Pt.II)-1974** or the latest version thereof.

### **3. INSULATORS**

#### **3.1 General Requirements**

**3.1.1** The porcelain shall be sound, free from defects, thoroughly vitrified and smoothly glazed.

**3.1.2** Unless otherwise specified, the glaze shall be brown in color. The glaze shall cover all the porcelain parts of the insulator except those areas which serve as supports during firing or are left unglazed for the purpose of assembly.

**3.1.3** The design of the insulator shall be such that stresses due to expansion and contraction in any part of the insulator shall not lead to deterioration. The porcelain shall not engage directly with hard metal.

**3.1.4** Cement used in the construction of the insulator shall not cause fracture by expansion or loosening by contraction and proper care shall be taken to locate the individual parts correctly during cementing. The cement shall not give rise to chemical reaction with metal fittings, and its thickness shall be as uniform as possible.

#### **3.2 Classification**

**3.2.1** Only Type 'B' insulators as defined in Indian Standards shall be used.

**3.2.2** The string insulators shall only be of ball and socket type.

### 3.3 Basic Insulation Levels

3.3.1 The test voltages of the insulators shall be as under :

**Table (Clause 3.3.1)**

Highest System Voltage	Visible Discharge Test	Wet Power Frequency Withstand Test	Power Frequency Withstand Test		Puncture	Impulse Voltage Withstand Test
			Pin	String Insulator Units		
kV (rms)	kV (rms)	kV (rms)	kV (rms)	kV(rms)		kV (Peak)
36	27	75	180	1.3 times the actual dry flashover voltage of the Unit.		170

3.3.2 In this specification, power frequency voltages are expressed as peak values divided by 2 and impulse voltages are expressed as peak values.

3.3.3 The withstand and flashover voltages are referred to the 'Reference Atmospheric Conditions' as per Indian Standard.

### 3.4 Mechanical Load

The insulators shall be suitable for the minimum failing loads specified as under:

Pin Insulator Failing loads	String Insulator Units	
	Failing Loads	Commended Pin Ball Shank Diameter
10 KN	45 KN	16 mm

### 2.5 Creepage Distance

The minimum creepage distance shall be as under:

Highest System Voltage	Normal and Moderately Polluted Atmosphere (Total)	Heavily polluted Atmosphere (Total)
1	2	3
36KV	580mm	840mm

**Note:** For insulator used in an approximately vertical position the values given in Col. (2) or (3) shall apply. For insulators used in an approximately horizontal position, the value given in Col. (2) shall apply but the value in Col. (3) may be reduced by as much as 20%.

### 3.6 Tests :

The insulators shall comply with the following tests as per **IS:731-1971** and latest version thereof.

#### 3.6.1 Type Tests

- a) Visual examination,
- b) Verification of dimensions,
- c) Visible discharge test,
- d) Impulse voltage withstand test,
- e) Wet power-frequency voltage withstand test,
- f) Temperature cycle test,
- g) Electro-mechanical failing load test
- h) Mechanical failing load test (for those of Type B string insulator units to which electromechanical failing load test (g) is not applicable).
- i) Twenty-four hours mechanical strength test (for string insulators only when specified by the purchaser.
- j) Puncture Test
- k) Porosity test and
- l) Galvanizing test

#### 3.6.2 Acceptance Tests

The test samples after having withstood the routine tests shall be subjected to the following acceptance test in the order indicated below:

- a) Verification of dimensions.
- b) Temperature cycle test
- c) Twenty four hours mechanical strength test (for string insulator units only when specified by the purchaser)

- d) Electro-mechanical failing load test.
- e) Puncture test.
- f) Porosity test and
- g) Galvanizing test

### **3.6.3 Routine Test**

- a) Visual examination.
- b) Mechanical routine test (for string insulator units only) and
- c) Electrical routine test (for string insulator units only)

## **3.7 Marking**

**3.7.1** Each insulator shall be legibly and indelibly marked to show the following:

- a) Name or trademark of the manufacturer
- b) Month and year of manufacture
- c) Minimum failing load in Newtons
- d) Country of the manufacture and
- e) ISI Certification mark, if any.

**3.7.2** Marking on porcelain shall be printed and shall be applied before firing.

## **3.8 Packing**

All insulators (without fittings) shall be packed in wooden crates suitable for easy but rough handling and acceptable for rail transport. Where more than one insulator is packed in a crate, wooden separators shall be fixed between the insulators to keep individual insulators in position without movement within the crate. Disc insulators, however, may be assembled in string and packed inside a crate to prevent movement.

## **4. INSULATOR FITTINGS**

### **4.1 Pins for Pin Insulators**

#### **4.1.1 General Requirements**

**4.1.1.1** The pin shall be a single piece obtained preferably by the process of forging. It shall not be made by joining, welding, shrink-fitting or any other process from more than one piece of material. It shall be of good finish, free from flaws and other defects. The finish of the collar shall be such that a sharp angle between the collar and the shank is avoided.

**4.1.1.2** All ferrous pins, nuts and washer except those made of stainless steel shall be galvanized. The threads of nuts shall be cut after galvanizing and shall be well oiled and greased.

#### **4.1.2 Type & Dimensions**

**4.1.2.1** Pins with large steel head Type L300N as per **IS:2486 (Pt.II)** having stalk length of 300 mm and shank length of 150 mm with minimum failing load of 10 KN shall be used.

**4.1.2.2** The complete details of the pin are given in Fig.1.

#### **4.1.3 Tests**

Insulator pins shall comply with the following tests as per **IS:2486 (pt.I)**.

##### **4.1.3.1 Type Tests**

- a) Visual examination test
- b) Checking of threads on heads
- c) Galvanising test and
- d) Mechanical test

##### **4.1.3.2 Acceptance Tests**

- a) Checking of threads on heads
- b) Galvanising test and
- c) Mechanical test

##### **4.1.3.3 Routine Test**

Visual examination

## 4.2 String Insulator Fittings

### 4.2.1 General Requirements

**4.2.1.1** All forgings and castings shall be of good finish and free of flaws and other defects. The edges on the outside of fittings, such as at the ball socket and holes, shall be rounded.

**4.2.1.2** All parts of different fittings which provide for interconnection shall be made such that sufficient clearance is provided at the connection point to ensure free movement and suspension of the insulator string assembly. All ball and socket connections shall be free in this manner, but care shall be taken that too much clearance between ball and socket is avoided.

**4.2.1.3** All ferrous fittings and the parts other than those of stainless steel, shall be galvanized. Small fittings like spring washers, nuts, etc. may be electro-galvanized.

### 4.2.2. Type and Dimensions

**4.2.2.1** Only ball and socket type insulator sets shall be used. The nominal dimensions of the ball and sockets, ball eye and cross-arm straps are given in Fig. 2. An assembly drawing of the complete insulator string is given in Fig. 3.

**4.2.2.2** Strain clamps shall be suitable for ACSR conductors 7/3.35 mm<sup>2</sup> (50 mm<sup>2</sup> Al. area), 7/4.09mm (80mm<sup>2</sup> Al. area) and 6/4.72mm + 7/1.57 mm (100 mm<sup>2</sup> Al. area). The ultimate strength of clamps shall not be less than 41 KN.

### 4.2.3 Tests

String insulator fittings shall comply with the following tests as per **IS:2486 (Pt.I)**.

#### 4.2.3.1 Type Tests

- a) Slip strength test
- b) Mechanical test
- c) Electrical resistance test

- d) Heating cycle test
- e) Verification of dimensions
- f) Galvanising/Electroplating test, and
- g) Visual examination test

#### **4.2.3.2 Acceptance Tests**

- a) Verification of dimensions
- b) Galvanising/Electroplating test, and
- c) Mechanical tests

#### **4.2.3.3 Routine Tests**

- a) Visual examination test and
- b) Routine mechanical test

#### **4.2.4 Marking**

**4.2.4.1** The caps and clamps shall have marked on them the following :

- a) Name or trade mark of the manufacturer and
- b) Year of manufacture

#### **4.3 Packing**

**4.3.1** For packing of GI pins, strain clamps and related hardware, double gunny bags (or wooden cases, if deemed necessary) shall be employed. The heads and threaded portions of pins and the fittings shall be properly protected against damage. The gross weight of each packing shall not normally exceed 50 Kg. Different fittings shall be packed in different bags or cases and shall be complete with their minor accessories fitted in place. All nuts shall be hand-tightened over the bolts and screwed upto the farthest point.

**4.3.2** The packages containing fittings may also be marked with the ISI certification mark.



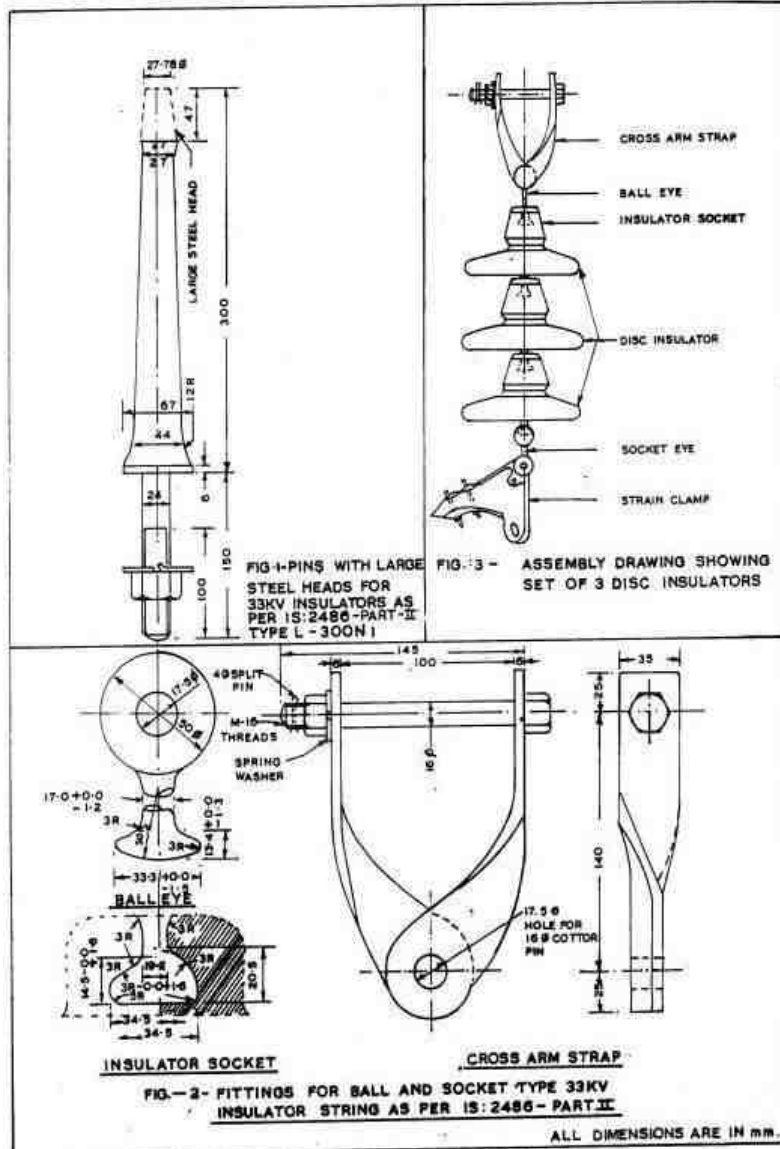

Fig.2 & Fig.3

**22. 33 kV and 11 kV Post Insulator****1 GENERAL REQUIREMENTS**

- I.** The porcelain shall be sound and free from defects, thoroughly vitrified and smoothly glazed.
- II.** Unless otherwise specified the glaze shall be brown in colour. The glaze shall cover all the exposed porcelain part of the insulator except those areas which serve as support or required to be left un-glazed.
- III.** Precaution shall be taken during design and manufacture to avoid the following:
  - a) Stress due to expansion and contraction which may lead to deterioration.
  - b) Stress concentration due to direct engagement of the porcelain with the metal fittings.
  - c) Retention of water in the recesses of metal fitting and
  - d) Shapes which do not facilitate easy cleaning by normal methods.
- IV.** Cement used in the construction of the post insulator shall not cause fracture by expansion or loosening by contraction and proper care shall be taken to locate the individual parts correctly during cementing. Further, the cement shall not give rise to chemical reaction with metal fittings and its thickness shall be as uniform as possible.
- V.** All ferrous metal parts except those of stainless steel, shall be hot dip galvanized and the uniformity of zinc coating shall satisfy the requirements of IS : 2633. The parts shall be galvanized after mechanising. The finished galvanized surface shall be smooth.
- VI.** The threads of the tapped holes in the post insulators metal fittings shall be cut after giving anti-corrosion protection and shall be protected against rust by greasing or by other similar means. All other threads shall be cut before giving anti-corrosion protection. The tapped holes shall be suitable for bolts with threads having anti-corrosion protection and shall conform to IS : 4218(Part-I to VI). The effective length of thread shall not be less than the nominal diameter of the bolt.
- VII.** The post insulator unit shall be assembled in a suitable jig to ensure the correct positioning of the top and bottom metal fitting relative to one another. The faces of the metal fittings shall be parallel and at right angles to the axis of the insulator and the

corresponding holes in the top and bottom metal fittings shall be in a vertical plane containing the axis of insulator.

## 2 CLASSIFICATION

The post insulators shall be of type 'B' according to their construction, which is defined here under:

A post insulator or a post insulator unit in which the length of the shortest puncture path through solid insulating material is less than half the length of the shortest flash over path through air outside the insulator.

## 3 Standard insulation levels:

I. The standard insulator levels of the post insulator or post insulator unit shall be as under:

Highest system voltage	Visible discharge test	Dry one minute power frequency withstand test.	Wet one minute power frequency withstand test.	Power frequency puncture withstand test.	Impulse voltage withstand test.
12 kV (rms)	9 kV(rms)	35 kV(rms)	35 kV(rms)	1.3 times the actual dry flash over voltage of the unit (kVrms)	75 kV peak
36 kV (rms)	27 kV(rms)	75 kV(rms)	75 kV(rms)	1.3 times the actual dry flash over voltage of the unit (kVrms)	170 kV peak

II. In this standard, power frequency voltage is expressed as peak values divided by  $\sqrt{2}$ . The impulse voltages are expressed as peak values.

III. The withstand and flashover voltage are referred to the atmospheric condition.

## 4 TESTS

**I.** The insulators shall comply with the following constitute the type tests:

- a) Visual examination.
- b) Verification of dimensions.
- c) Visible discharge test.
- d) Impulse voltage withstand test.
- e) Dry power frequency voltage withstand test.
- f) Wet power frequency voltage withstand test.
- g) Temperature cycle tests.
- h) Mechanical strength tests.
- i) Puncture test.
- j) Porosity test.
- k) Galvanizing test.

Type test certificates for the tests carried out on prototype of same specifications shall be enclosed with the tender and shall be subjected to the following acceptance test in the order indicated below.\

**II. Acceptance test:**

The test samples after having withstood routine test shall be subjected to the at least following acceptance test in the order indicated below:

- a) Verification of dimensions.
- b) Temperature cycle tests.
- c) Mechanical strength tests.
- d) Puncture test.
- e) Porosity test.
- f) Galvanizing test.

**III. Routine tests:**

The following shall be covered under routine tests on each post insulator or post insulator unit.

- a) Visual examination as per Cl. No.- 9.12 of IS: 2544/1973
- b) Mechanical routine test as per Cl. No.- 9.14 of IS: 2544/1973
- c) Electrical routine test as per Cl. No.- 9.13 of IS: 2544/1973

**5 MARKING****I.** Each post insulator shall be legibly and indelibly marked to show the following.

- a) Name or trademark of the manufacturer.
- b) Month & year of manufacture.

c) Country of manufacture.

**II.** Marking on porcelain shall be printed and shall be applied before firing.

**III.** Post insulator or post insulator units may also be mark with I.S.I. certification mark.

## **6 PACKING**

All post insulators shall be pack in wooden crates suitable for easy but rough handling and acceptable for rail, transport. Where more than one insulator is packed in a crate wooden separator shall be fixed between the insulators to keep individual insulator in position without movement within the crate.

**Table-I**

<b>Highest System Voltage in kV</b>	<b>Minimum Creepage distance in mm</b>
	Post insulator
12	320
36	900

## **ANNEXURE – A**

### **1 Hydraulic Internal Pressure Test on Shells (if applicable)**

The test shall be carried out on 100%-disc strain insulator shells before assembly. The details regarding test will be as discussed and mutually agreed to by the Contractor and Owner in Quality Assurance Programme.

### **2 Thermal Mechanical Performance Test**

Thermal Mechanical Performance Test shall be performed in accordance with IEC-383-1-1993 Clause 20 with the following modifications:

(1) The applied mechanical load during this test shall be 70% of the rated electromechanical or mechanical value.

(2) The acceptance criteria shall be

(a)  $X$  greater than or equal to  $R+ 3S$ .

Where,

$X$  Mean value of the individual mechanical failing load.

$R$  Rated electro-mechanical / mechanical failing load.

S Standard deviation.

- (b) The minimum sample size shall be taken as 20 for disc insulator units.
- (c) The individual electromechanical failing load shall be at least equal to the rated value. Also, puncture shall not occur before the ultimate fracture.

### 3 **Electromechanical/Mechanical Failing Load Test.**

This test shall be performed in accordance with clause 18 and 19 of IEC 383 with the following acceptance

- (i)  $X$  greater than or equal to  $R + 3S$

Where,

X Mean value of the electro-mechanical/mechanical/ failing load.

R Rated electro-mechanical / mechanical failing load.

S Standard deviation.

- (ii) The minimum sample size shall be taken as 20 for disc insulators units. However, for larger lot size, IEC 591 shall be applicable.
- (iii) The individual electro-mechanical/mechanical failing load shall be at least equal to the rated value. Also, electrical puncture shall not occur before the ultimate fracture.

### 4 **Chemical Analysis of Zinc used for Galvanizing**

Samples taken from the zinc ingot shall be chemically analysed as per IS:209. The purity of zinc shall not be less than 99.95%.

### 5 **Tests for Forgings**

The chemical analysis, hardness tests and magnetic particle inclusion test for forgings, will be as per the internationally recognised procedures for these tests. The sampling will be based on heat number and heat treatment batch. The details regarding test will be as discussed and mutually agreed to by the Contractor and Owner in Quality Assurance Programme.

### 6 **Tests on Castings**

---

The chemical analysis, mechanical and metallographic tests and magnetic particle inclusion for castings will be as per the internationally recognised procedures for these tests. The samplings will be based on heat number and heat treatment batch. The details regarding test will be as discussed and mutually agreed to by the Contractor and Owner in Quality Assurance Programme.

**23. 11 kV/22 kV/33 kV Composite Insulators****1) SCOPE :**

This specification covers the design, manufacture, testing and supply of 11KV / 22KV / 33 KV Composite Insulators. The composite insulators shall be of the following type:

- i) Long rod insulators for conductors in tension application at angle / cut points the insulators shall be of tongue & clevis type.
- ii) Line post insulators or pin insulators for straight line locations

**2) SERVICE CONDITIONS :**

The insulators to be supplied against this specification shall be suitable for satisfactory continuous operation under the following tropical conditions.

Maximum ambient temperature (Degree C)	...	50
Minimum ambient temperature (Degree C)	...	3.5
Relative Humidity (%)	...	10 to 100
Maximum Annual Rainfall (mm)	...	1450
Maximum Wind pressure (kg/m.sq.)	...	150
Maximum wind velocity (km/hour)	...	45
Maximum altitude above mean sea level (meter)	...	1000
Isoceraunic level (days/year)	...	50
Seismic level (Horizontal acceleration)	...	0.3 g
Moderately hot and humid tropical climate Conductive to rust and fungus growth		

**3) SYSTEM PARTICULARS:**

a) Nominal System Voltage	11 kV	22 kV	33 kV
b) Corresponding highest system Voltage	12 kV	24kV	36 kV
c) Frequency	50 Hz with 3% tolerance		
d) Number of phase	3	3	3
e) Neutral earthing	effectively grounded.		

**4) STANDARDS :**





	s	e kV (rms)		kV(rms)	Withstan d Voltage kV(rms)		(mm) (Heavily Polluted 25mm/k V)	Between Tongue & Clevis (mm)	kN	min)
i.	Long Rod insulator	11	12	9	35	75	320	300	45	75-
		22	24	18	55	125	600	450	70	100
		33	36	27	75	170	900	550	70	100
ii.	Post/Pin Insulator	11	12	9	35	75	320		5	
		22	24	18	55	125	560		10	
		33	36	27	75	170	900		10	

\* Amendment issued vide letter No.REC/DDUGJY/SBD/749 Dated 27-07-2016

vii) Dimensional Tolerance of Composite Insulators

The tolerances on all dimensions e.g. diameter, length and creepage distance shall be allowed as follows in line with-IEC 61109:

(0.04d+1.5) mm when  $d \leq 300$ mm.

(0.025d+6) mm when  $d > 300$  mm.

Where, d being the dimensions in millimeters for diameter, length or creepage distance as the case may be. However no negative tolerance shall be applicable to creepage distance.

viii) Interchangeability:

The composite insulator together with the tongue & clevis fittings shall be of standard design suitable for use with the hardware of any other indigenous make conforming to relevant standards referred above.

ix) Corona and RI Performance

All surfaces shall be clean, smooth, without cuts, abrasions or projections. No part shall be subjected to excessive localized pressure. The insulator and metal parts shall

be so designed and manufactured that it shall avoid local corona formation and not generate any radio interference beyond specified limit under the operating conditions.

6) **TECHNICAL DESCRIPTION OF COMPOSITE INSULATORS**

Polymeric Insulators shall be designed to meet the high quality, safety and reliability and are capable of withstanding a wide range of environmental conditions.

Polymeric Insulators shall consist of THREE parts, at least two of which are insulating parts:-

- (a) Core- the internal insulating part
- (b) Housing- the external insulating part
  
- (c) Metal end fittings.

i) **CORE**

It shall be a glass-fiber reinforced epoxy resin rod of high strength (FRP rod). Glass fibers and resin shall be optimized in the FRP rod. Glass fibers shall be Boron free electrically corrosion resistant (ECR) glass fiber or Boron free E-Glass and shall exhibit both high electrical integrity and high resistance to acid corrosion. The matrix of the FRP rod shall be Hydrolysis resistant. The FRP rod shall be manufactured through Pultrusion process. The FRP rod shall be void free.

ii) **HOUSING:**

The FRP rod shall be covered by a seamless sheath of a silicone elastometric compound or silicone alloy compound of a thickness of 3mm minimum. It shall be one-piece housing using Injection Molding Principle to cover the core. The elastomer housing shall be designed to provide the necessary creepage distance and protection against environmental influences. Housing shall conform to the requirements of IEC 61109/92-93 with latest amendments

iii) **WEATHERSHEDS**

The composite polymer weather sheds made of a silicone elastometric compound or silicone alloy compound shall be firmly bonded to the sheath, vulcanized to the sheath or molded as part of the sheath and shall be free from imperfections It should protect the FRP rod against environmental influences, external pollution and humidity. The weather sheds should have silicon content of minimum 30% by weight. The strength of

the weather shed to sheath interface shall be greater than the tearing strength of the polymer. The interface, if any, between sheds and sheath (housing) shall be free from voids.

iv) **METAL END FITTINGS:**

End fitting transmit the mechanical load to the core. They shall be made of spheroidal graphite cast iron, malleable cast iron or forged steel or aluminum alloy. They shall be connected to the rod by means of a controlled compression technique. Metal end fittings shall be suitable for tongue & clevis hard wares of respective specified mechanical load and shall be hot dip galvanized after, all fittings have been completed. The material used in fittings shall be corrosion resistant. As the main duty of the end fittings is the transfer of mechanical loads to the core the fittings should be properly attached to the core by a coaxial or hexagonal compression process & should not damage the individual fibers or crack the core. The gap between fitting and sheath shall be sealed by a flexible silicone elastomeric compound or silicone alloy compound sealant. System of attachment of end fitting to the rod shall provide superior sealing performance between housing, i.e. seamless sheath and metal connection. The sealing must be moisture proof. The dimensions of end fittings of insulators shall be in accordance with the standard dimensions stated in IEC: 60120/ IS: 2486 - Part-II /1989.

7) **WORKMANSHIP**

- 7.1 All the materials shall be of latest design and conform to the best engineering practices adopted in the high voltage field. Manufacturers shall offer only such insulators as are guaranteed by them to be satisfactory and suitable for continued good service in power transmission lines.
- 7.2 The design, manufacturing process and material control at various stages shall be such as to give maximum working load, highest mobility, best resistance to corrosion, good finish and elimination of sharp edges and corners.
- 7.3 The design of the insulators shall be such that stresses due to expansion and contraction in any part of the insulator shall not lead to deterioration.
- 7.4 The core shall be sound and free of cracks and voids that may adversely affect the insulators.
- 7.5 Weather sheds shall be uniform in quality. They shall be clean, sound, smooth and

shall be free from defects and excessive flashing at parting lines.

- 7.6 End fittings shall be free from cracks, seams, shrinks, air holes and rough edges. End fittings should be effectively sealed to prevent moisture ingress; effectiveness of sealing system must be supported by test documents. All surfaces of the metal parts shall be perfectly smooth with out projecting points or irregularities, which may cause corona.

All load bearing surfaces shall be sooth and uniform so as to distribute the loading stresses uniformly.

- 7.7 All ferrous parts shall be hot dip galvanized to give a minimum average coating of zinc equivalent to 610 gm/sq.m. or 87 microm thickness and shall be in accordance with the requirement of IS:4759. the zinc used for galvanizing shall be of purity 99.5% as per IS:4699. The zinc coating shall be uniform, adherent, smooth, reasonably bright continuous and free from imperfections such as flux, ash rust stains, bulky white deposits and blisters. The galvanized metal parts shall be guaranteed to withstand at least four successive dips each lasting for one (1) minute duration under the standard preece test. The galvanizing shall be carried out only after any machining.

8) **TESTS AND STANDARDS**

Insulators offered shall be manufactured with the same configuration & raw materials as used in the insulators for which design & type test reports are submitted. The manufacturer shall submit a certificate for the same. The design & type test reports submitted shall not be more than five years old.

8.1 **DESIGN TESTS :**

For polymeric insulators it is essential to carry out design test as per clause 4.1 of IEC 61109 / 92-93 with latest amendments. The design tests are intended to verify the suitability of the design, materials and method of manufacture (technology). When a composite insulator is submitted to the design tests, the result shall be considered valid for the whole class of insulators, which are represented by the one tested and having the following characteristics:

- Same materials for the core, and sheds and same manufacturing method;
- Same material of the fittings, the same design, the same method of attachment;

Same or greater layer thickness of the shed material over the core (including a sheath where used );

- Same or smaller ratio of the highest system voltage to insulation length;
- Same or smaller ratio of all mechanical loads to the smallest core diameter between fittings
- Same or greater diameter of the core.

The tested composite insulators shall be identified by a drawing giving all the dimensions with the manufacturing tolerances.

Manufacturer should submit test reports for Design Tests as per IEC – 61109 (clause – 5). Additionally following tests shall be carried out or reports for the tests shall be submitted after award of contract:

UV test: the test shall be carried out in line with clause 7.2 of ANSI C29.13.

## 8.2 TYPE TESTS :

The type tests are intended to verify the main characteristics of a composite insulator. The type tests shall be applied to composite insulators, the class of which has passed the design tests.

- 8.2.1 Following Type test shall be conducted on a suitable number of individual insulator units, components, materials or complete strings:

Sl. No	Description of type test	Test procedure / standard
1	Dry lightning impulse withstand voltage test	As per IEC 61109(Clause 6.1)
2	Wet power frequency test	As per IEC 61109(Clause 6.2)
3	Mechanical load-time test	As per IEC 61109(Clause 6.4)
4	Radio interference test	As per IEC 61109(Clause 6.5) revised
5	Recovery of Hydrophobicity test	Annexure – B This test may be repeated every 3yrs by the manufacturer
6	Chemical composition test for silicon content	Annexure – B Or any other test

		method acceptable to the Employer
7	Brittle fracture resistance test	Annexure – B

The Manufacturer shall submit type test reports as per IEC 61109. Additional type tests required if any shall be carried out by the manufacturer, after award of contract for which no additional charges shall be payable. In case, the tests have already been carried out, the manufacturer shall submit reports for the same.

### 8.3 ACCEPTANCE TESTS :

The test samples after having withstood the routine test shall be subject to the following acceptance tests in order indicated below:

(a)	Verification of dimensions	: Clause 7.2 IEC: 61109,
(b)	Verification of the locking system (if applicable)	: Clause 7.3 IEC: 61109,
(c)	Verification of tightness of the interface Between end fittings & Insulator housing	: Clause 7.4 IEC: 61109 amendment 1 of 1995
(d)	Verification of the specified mechanical load	: Clause 7.4 IEC: 61109, amendment 1 of 1995
(e)	Galvanizing test	: IS:2633/IS:6745

### 8.4 ROUTINE TESTS:

Sr.No.	Description	Standard
1	Identification of marking	As per IEC: 61109 Clause 8.1
2	Visual Inspection	As per IEC: 61109 Clause 8.2
3	Mechanical routine test	As per IEC: 61109 Clause 8.3

Every polymeric insulator shall withstand mechanical routine test at ambient temperature tensile load at RTL corresponding to at least 50 % of the SML for at least 10 sec.

### 8.5 TESTS DURING MANUFACTURE:

Following tests shall also be carried out on all components as applicable

- (a) Chemical analysis of zinc used for galvanizing

- (b) Chemical analysis, mechanical, metallographic test and magnetic particle inspection for malleable castings.
- (c) Chemical analysis, hardness tests and magnetic particle inspection for forgings.

#### 8.6 SAMPLE BATCH FOR TYPE TESTING :

The Manufacturer shall offer material for sample selection for type testing only after getting Quality Assurance Plan approved by Employer. The sample for type testing will be manufactured strictly in accordance with the approved Quality Assurance Plan.

#### 9) **QUALITY ASSURANCE PLAN :**

##### 9.1 The Manufacturer shall submit following information:

- i) Test certificates of the raw materials and bought out accessories.
- ii) Statement giving list of important raw material, their grades along with names of sub-Manufacturers for raw materials, list of standards according to which the raw materials are tested. List of tests normally carried out on raw materials in presence of Manufacturer's representative.
- iii) List of manufacturing facilities available.
- iv) Level of automation achieved and lists of areas where manual processing exists.
- v) List of areas in manufacturing process, where stage inspections are normally carried out for quality control and details of such tests and inspections.
- vi) List of testing equipments available with the Manufacturer for final testing of equipment along with valid calibration reports.
- vii) The manufacturer shall submit Manufacturing Quality Assurance Plan (QAP) for approval

& the same shall be followed during manufacture and testing.

##### 9.2 The Manufacturer shall submit the routine test certificates of bought out raw materials/accessories and central excise passes for raw material at the time of inspection.



- 9.3 The Employer's representative shall at all times be entitled to have access to the works and all places of manufacture, where insulator, and its component parts shall be manufactured and the representatives shall have full facilities for unrestricted inspection of the Manufacturer's and sub-Manufacturer's works, raw materials, manufacture of the material and for conducting necessary test as detailed herein.
- 9.4 The material for final inspection shall be offered by the Manufacturer only under packed condition. The Employer shall select samples at random from the packed lot for carrying out acceptance tests. The lot offered for inspection shall be homogeneous and shall contain insulators manufactured in 3-4 consecutive weeks.
- 9.5 The Manufacturer shall keep the Employer informed in advance of the time of starting and the progress of manufacture of material in their various stages so that arrangements could be made for inspection.
- 9.6 No material shall be dispatched from its point of manufacture before it has been satisfactorily inspected and tested unless the Employer in writing waives off the inspection. In the later case also the material shall be dispatched only after satisfactory testing specified herein has been completed.
- 9.7 The acceptance of any quantity of material shall in no way relieve the Manufacturer of his responsibility for meeting all the requirements of the specification and shall not prevent subsequent rejection, if such material are later found to be defective

10) **TEST CERTIFICATE :**

The manufacturer shall furnish detailed type test reports of the offered composite Insulators as per clause 8.2 of the Technical Specifications at the NABL approved laboratories to prove that the composite Insulators offered meet the requirements of the specification. These Type Tests should have been carried out within five years prior to the date of opening of this manufacturer

The Employer reserves right to demand repetition of some or all the Type Test in presence of Employer's representative. For this purpose, the manufacturer shall quote unit rates for carrying out each Type Test. However, such unit rates will not be considered for evaluation of the offer. In case the unit fails in the Type Tests, the complete supply shall be rejected.

11) **TESTING FACILITIES :**

The manufacturer must clearly indicate what testing facilities are available in the works of the manufacturer and whether facilities are adequate to carry out all Routine & acceptance Tests. These facilities should be available to Employer's Engineers if deputed or carry out or witness the tests in the manufacturer works. The insulators shall be tested in accordance with the procedure detailed in IEC 61109 / 92-93 with latest amendments.

12) **DRAWINGS :**

- (i) The Manufacturer shall furnish full description and illustration of the material offered.
- (ii) The Manufacturer shall furnish the outline drawing (3 copies) of each insulator unit including a cross sectional view of the long rod insulator unit. The drawing shall include but not be limited to the following information:

- Long rod diameter with manufacturing tolerances
- Minimum Creepage distance with positive tolerance

- Protected creepage distance
- Eccentricity of the long rod unit

- Axial run out

- Radial run out

- Unit mechanical and electrical characteristics
- Size and weight of ball and socket/tongue & clevis
- Weight of composite long rod units
- Materials

- Identification mark
- Manufacturer's catalogue number

- (iii) After placement of award the Manufacturer shall submit fully dimensioned insulator crate drawing for different type of insulators for approval of the Employer.

13) **RETEST AND REJECTION:**

- 13.1 Sample Procedure for testing of insulators shall be as per clause 7.1 to 7.6 of IEC

## 61109 for Acceptance &amp; Routine Tests.

For the sampling tests, two samples are used, E1 and E2. The sizes of these samples are indicated in the table below.

Lot Size (N)	Sample Size	
	E1	E2
N < 300	Subject to agreement	
300 < N < 2000	4	3
2000 < N < 5000	8	4
5000 < N < 10000	12	6

If more than 10000 insulators are concerned, they shall be divided into an optimum number of lots comprising between 2000 and 10000 insulators. The results of the tests shall be evaluated separately for each lot.

The insulators shall be selected by the Employer's representative from the lot at random.

The samples shall be subjected to the applicable sampling tests.

The sampling tests are:

- Verification of dimensions - (E1 + E2)
- Verification of the locking system - (E2)
- Verification of tightness of the interface between end fittings & Insulator housing - (E2)
- Verification of the specified mechanical load SML - (E1)
- Galvanizing test - (E2)

In the event of a failure of the sample to satisfy a test, the retesting procedure shall be as follows :

If only one insulator or metal part fails to comply with the sampling tests, a new sample equal to twice the quantity originally submitted to the tests shall be subjected to retesting. The retesting shall comprise the test in which failure occurs. If two or more insulator or metal parts fail to comply with any of the sampling tests or if any failure occurs during the retesting, the complete lot is considered as not complying with this standard and shall be withdrawn by the manufacturer.

Provided the cause of the failure can be clearly identified, the manufacturer may sort the lot to eliminate all the insulators with these defects. The sorted lot then be

resubmitted for testing. The number then selected shall be three times the first chosen quantity for tests. If any insulators fail during this retesting, the complete lot is considered as not complying with this standard and shall be withdrawn by the manufacturer.

### 13.2 Verification of dimensions (E1 + E2)

The dimensions given in the drawings shall be verified. The tolerances given in the drawing are valid. If no tolerances are given in the drawings the values mentioned in this specification shall hold good.

### 13.3 Verification of the locking system (E2)

This test applies only to the insulators equipped with socket coupling as specified by IEC 120 and is performed according to IEC 383.

### 13.4 Verification of tightness of the interface between end fittings & Insulator housing (E2)

One insulator selected randomly from the sample E2, shall be subjected to crack indication by dye penetration, in accordance with ISO 3452, on the housing in the zone embracing the complete length of the interface between the housing and metal fitting and including an additional area, sufficiently extended beyond the end of the metal part.

The indication shall be performed in the following way.

- (i) the surface shall be properly pre-cleaned with the cleaner ;
- (ii) the penetrant, which shall act during 20 minutes, shall be applied on the cleaned surface;
- (iii) with in 5 minutes after the application of the penetrant, the insulator shall be subjected, at the ambient temperature, to a tensile load of 70 % of the SML, applied between the metal fittings; the tensile load shall be increased rapidly but smoothly from zero up to 70 % of the SML, and then maintained at this value for 1 minute;
- (iv) the surface shall be cleaned with the excess penetrant removed, and dried;
- (v) the developer shall be applied if necessary;

(vi) the surface shall be inspected.

Some housing materials may be penetrated by the penetrant. In such cases evidence shall be provided to validate the interpretation of the results.

After the 1 min. test at 70 % of the SML, if any cracks occur, the housing and, if necessary, the metal fittings and the core shall be cut, perpendicularly to the crack in the middle of the widest of the indicated cracks, into two halves. The surface of the two halves shall then be investigated for the depth of the cracks.

### 13.5 Verification of the specified mechanical load SML

The insulators of the sample E1 shall be subjected at ambient temperature to a tensile load, applied between the couplings. The tensile load shall be increased rapidly but smoothly from zero to approximately 75 % of the SML, and then be gradually increased to the SML in a time between 30 sec. to 90 sec.

If 100 % of the SML is reached in less than 90 s, the load (100 % of the SML) shall be maintained for the remainder of the 90 s. (This test is considered to be equivalent to a 1min withstand test at the SML.)

The insulators have passed the test at 13.4 & 13.5 above if:

No failure (breakage or complete pull out of the core, or fracture of the metal fitting) occurs either during the 1 min. 70 % withstand test (a) or during the 1 min.100 % withstand test (b).

No cracks are indicated after the dye penetration method described in 13.4 above.

The investigation of the halves described in 13.4 above shows clearly that the cracks do not reach the core.

### 13.6 Galvanizing test

This test shall be performed according to IS: 2633/IS: 6745 on galvanized parts.

## 14) **MARKINGS :**

14.1 Each insulator shall be legibly and indelibly marked with the following details as per IEC- 61109:

- a) Name or trademark of the manufacturer.
- b) Voltage & Type
- c) Month and year of manufacturing.
- d) Min. failing load/guaranteed mechanical strength in kilo Newton followed by the word 'KN' to facilitate easy identification.
- e) RDSS 'Employer Name'. Marking

14.2 One 10 mm thick ring or 20 mm thick spot of suitable quality of paint shall be marked on the end fitting of each composite long rod of particular strength for easy identification. The paint shall not have any deteriorating effect on the insulator performance.

Following codes shall be used as identification mark:

For 45 KN long rod units	: Blue
For 70 KN long rod units	: Red

15) **PACKING :**

- 15.1 All insulators shall be packed in strong corrugated box of min. 7 ply duly palletted or wooden crates. The gross weight of the crates along with the material shall not normally exceed 100 Kg to avoid hackling problem. The crates shall be suitable for outdoor storage under wet climate during rainy season.
- 15.2 The packing shall be of sufficient strength to withstand rough handling during transit, storage at site and subsequent handling in the field.
- 15.3 Suitable cushioning, protective padding, or Dunn age or spacers shall be provided to prevent damage or deformation during transit and handling.
- 15.4 All packing cases shall be marked legibly and correctly so as to ensure safe arrival at their destination and to avoid the possibility of goods being lost or wrongly dispatched on account of faulty packing and faulty or illegible markings. Each wooden case /crate /corrugated box shall have all the markings stenciled on it in indelible ink.
- 15.5 The Manufacturer shall provide instructions regarding handling and storage

precautions to be taken at site.

16) **GUARANTEE**

The Manufacturer of insulators shall guarantee overall satisfactory performance of the insulators. The manufacturerer shall furnish in the form attached (Schedule 'A') all the guaranteed technical particulars.

**SCHEDULE – A1****GUARANTEED TECHNICAL PARTICULARS.****COMPOSITE INSULATOR UNIT****11KV(45KN) / 11KV(70KN).****(to be filled separately for each type mentioned above)**

<b>Sr.No</b>	<b>Parameter Name</b>	<b>Parameter type</b>	
1.	Type of insulator	Text	
2.	Standard according to which the insulators manufactured and tested	Text	
3.	Name of material used in manufacture of the insulator with class/grade	Text	
3.1	Material of core (FRP rod) i) E-glass or ECR-glass ii) Boron content		
3.2	Material of housing & weather sheds (Silicon content by weight)	Text	
3.3	Material of end fittings	Text	
3.4	Sealing compound for end fitting	Text	
4.0	Colour	Text	
5.	<b>Electrical characteristics</b>		
5.1.	Nominal system voltage	KV (rms)	Numeric
5.2	Highest system voltage	KV (rms)	Numeric
5.3	Dry Power frequency withstand voltage	KV (rms)	Numeric
5.4	Wet Power frequency withstand voltage	KV (rms)	Numeric
5.5	Dry flashover voltage	KV (rms)	Numeric
5.6	Wet flash over voltage	KV (rms)	Numeric
5.7	Dry lighting impulse withstand voltage a) Positive b) Negative	KV (peak) KV (peak)	Numeric
5.8	Dry lighting impulse flashover voltage a) Positive b) Negative	KV (peak) KV (peak)	Numeric
5.9	RIV at 1 MHz when energized at 10 kV/ 30 kV (rms) under dry condition	Micro volts	Numeric
6.0	Creepage distance (Min.) (320mm)	(mm)	Numeric



Sr.No	Parameter Name	Parameter type
6.1	Center to center distance between tongue & clevis) (300mm) (mm)	Numeric
6.2	Shed diameter (100mm) (mm)	Numeric
7.0	Mechanical characteristics: Minimum failing load	Numeric KN
8.0	<b>Dimensions of insulator</b>	
8.1	Weight	Numeric Kg
8.2	Dia. of FRP rod:	Numeric mm
8.3	Length of FRP rod	Numeric mm
8.4	Dia. of weather sheds (100mm)	Numeric mm
8.5	Thickness of housing	Numeric mm
8.6	Dry arc distance	Numeric mm
8.7	Dimensioned drawings of insulator (including weight with tolerances in weight) enclosed.	Boolean
9.0.	Method of fixing of sheds to housing (Specify): Single mould or Modular construction (Injection molding / compression molding)	Text
10.0	No of weather sheds	Text
11.0	<b>Type of sheds</b>	
11.1	Aerodynamic	Text
11.2	With underribs	Text
12.	<b>Packing details</b>	
12.1	Type of packing	Text
12.2	No. of insulators in each pack	Text
12.3	Gross weight of package	Text
13.0	Design Test Report, Type Test Report of insulator enclosed.	Boolean
14.0	Any other particulars which the Manufacturer may like to give	File

**SCHEDULE – A2****GUARANTEED TECHNICAL PARTICULARS.****COMPOSITE INSULATOR UNIT****22KV (70KN)**

<b>Sr.No</b>	<b>Parameter Name</b>	<b>Parameter type</b>
1.	Type of insulator	Text
2.	Standard according to which the insulators manufactured and tested	Text
3.	Name of material used in manufacture of the insulator with class/grade	
3.1	Material of core (FRP rod) i) E-glass or ECR-glass ii) Boron content	Text
3.2	Material of housing & weather sheds (silicon content by weight )	Text
3.3	Material of end fittings	Text
3.4	Sealing compound for end fitting	Text
4.0	Colour	Text
5.	<b>Electrical characteristics</b>	
5.1.	Nominal system voltage KV (rms)	Numeric
5.2	Highest system voltage KV (rms)	Numeric
5.3	Dry Power frequency withstand voltage KV (rms)	Numeric
5.4	Wet Power frequency withstand voltage KV (rms)	Numeric
5.5	Dry flashover voltage KV (rms)	Numeric
5.6	Wet flash over voltage KV (rms)	Numeric
5.7	Dry lighting impulse withstand voltage a) Positive KV (peak) b) Negative KV (peak)	Numeric
5.8	Dry lighting impulse flashover voltage a) Positive KV (peak) b) Negative KV (peak)	Numeric
5.9	RIV at 1 MHz when energized at 10 kV/ 30 kV (rms) under dry condition Micro volts	Numeric
6.0	Creepage distance (Min.) mm	Numeric
6.1	Center to center distance between tongue & clevis (mm)	Numeric

Sr.No	Parameter Name	Parameter type
6.2	Shed diameter (mm)	Numeric
7.0	Mechanical characteristics:	Numeric
	Minimum failing load	
8.0	<b>Dimensions of insulator</b>	
8.1	Weight Kg	Numeric
8.2	Dia. of FRP rod: mm	Numeric
8.3	Length of FRP rod mm	Numeric
8.4	Dia. of weather sheds mm	Numeric
8.5	Thickness of housing mm	Numeric
8.6	Dry arc distance mm	Numeric
8.7	Dimensioned drawings of insulator (including weight with tolerances in weight) enclosed.	Boolean
9.0.	Method of fixing of sheds to housing (Specify): Single mould or Modular construction (Injection molding / compression molding)	Text
10.0	No of weather sheds	Text
11.0	<b>Type of sheds</b>	
11.1	Aerodynamic	Text
11.2	With underribs	Text
12.	<b>Packing details</b>	
12.1	Type of packing	Text
12.2	No. of insulators in each pack	Text
12.3	Gross weight of package	Text
13.0	Design Test Report, Type Test Report of insulator enclosed.	Boolean
14.0	Any other particulars which the Manufacturer may like to give	File

**SCHEDULE – A3****GUARANTEED TECHNICAL PARTICULARS.****COMPOSITE INSULATOR UNIT****33KV (70KN)**

<b>Sr.No</b>	<b>Parameter Name</b>	<b>Parameter type</b>
1.	Type of insulator	Text
2.	Standard according to which the insulators manufactured and tested	Text
3.	Name of material used in manufacture of the insulator with class/grade	
3.1	Material of core (FRP rod ) i) E-glass or ECR-glass ii) Boron content	Text
3.2	Material of housing & weather sheds (silicon content by weight )	Text
3.3	Material of end fittings	Text
3.4	Sealing compound for end fitting	Text
4.0	Colour	Text
5.	<b>Electrical characteristics</b>	
5.1.	Nominal system voltage KV (rms)	Numeric
5.2	Highest system voltage KV (rms)	Numeric
5.3	Dry Power frequency withstand voltage KV (rms)	Numeric
5.4	Wet Power frequency withstand voltage KV (rms)	Numeric
5.5	Dry flashover voltage KV (rms)	Numeric
5.6	Wet flash over voltage KV (rms)	Numeric
5.7	Dry lighting impulse withstand voltage a) Positive KV (peak) b) Negative KV (peak)	Numeric
5.8	Dry lighting impulse flashover voltage a) Positive KV (peak) b) Negative KV (peak)	Numeric
5.9	RIV at 1 MHz when energized at 10 kV/ 30 kV (rms) under dry condition Micro volts	Numeric
6.0	Creepage distance (Min.) mm	Numeric
6.1	Center to center distance between tongue & clevis (mm)	Numeric

Sr.No	Parameter Name	Parameter type
6.2	Shed diameter (mm)	Numeric
7.0	Mechanical characteristics: Minimum failing load	Numeric
8.0	<b>Dimensions of insulator</b>	
8.1	Weight	Numeric
8.2	Dia. of FRP rod:	Numeric
8.3	Length of FRP rod	Numeric
8.4	Dia. of weather sheds	Numeric
8.5	Thickness of housing	Numeric
8.6	Dry arc distance	Numeric
8.7	Dimensioned drawings of insulator (including weight with tolerances in weight) enclosed.	Boolean
9.0.	Method of fixing of sheds to housing (Specify): Single mould or Modular construction (Injection molding / compression molding)	Text
10.0	No of weather sheds	Text
11.0	<b>Type of sheds</b>	
11.1	Aerodynamic	Text
11.2	With underribs	Text
12.	<b>Packing details</b>	
12.1	Type of packing	Text
12.2	No. of insulators in each pack	Text
12.3	Gross weight of package	Text
13.0	Design Test Report, Type Test Report of insulator enclosed.	Boolean
14.0	Any other particulars which the Manufacturer may like to give	File

**ANNEXURE 'A'**

<b>Sr.</b>	<b>Indian Standard</b>	<b>Title</b>	<b>International Standard</b>
1	-	Definition, test methods and acceptance criteria for composite insulators for A.C. overhead lines above 1000V	IEC: 61109
2	IS: 731	Porcelain insulators for overhead power lines with a nominal voltage greater than 1000V	IEC: 60383
3	IS: 2071	Methods of High Voltage Testing	IEC: 60060-1
4	IS: 2486	Specification for Insulator fittings for Overhead power Lines with a nominal voltage greater than 1000V General Requirements and Tests Dimensional Requirements Locking Devices	IEC: 60120 IEC: 60372
5.	-	Thermal Mechanical Performance test and mechanical performance test on string insulator units	IEC: 60575
6.	IS: 13134	Guide for the selection of insulators in respect of polluted condition	IEC: 60815
7.	-	Characteristics of string insulator units of the long rod type	IEC: 60433
8.	-	Hydrophobicity Classification Guide	STRI guide 1.92/1
9.	-	Radio interference characteristics of overhead power lines and high-voltage equipment.	CISPR: 18-2 Part 2
10.	IS: 8263	Methods of RI Test of HV insulators	IEC: 60437
11.		Standard for Insulators- Composite-Distribution Dead-end Type	ANSI C29.13-2000
12.	IS: 4759	Hot dip zinc coatings on structural steel & other allied products	ISO: 1459 ISO: 1461
13.	IS: 2629	Recommended Practice for Hot, Dip Galvanization for iron and steel	ISO: 1461 (E)
14.	IS: 6745	Determination of Weight of Zinc Coating on Zinc coated iron and steel articles	ISO: 1460
15.	IS: 3203	Methods of testing of local thickness of electroplated coatings	ISO: 2173
16.	IS: 2633	Testing of Uniformity of Coating of zinc coated articles	
17.	-	Standard specification for glass fiber strands	ASTM D 578-05
18.	-	Standard test method for compositional analysis by Thermogravimetry	ASTM E 1131-03
19.	IS:4699	Specification for refined secondary Zinc	

**STANDARDS TO BE ADOPTED FOR COMPOSITE INSULATORS**



## **Annexure-B**

### **Tests on Insulator units**

#### **1 RIV Test (Dry)**

The insulator string along with complete hardware fittings shall have a radio interference voltage level below 100 micro volts at one MHz when subjected to 50 Hz AC voltage of 10kV & 30 kV for 11 kV & 33 kV class insulators respectively under dry condition. The test procedure shall be in accordance with IS:8263 /IEC:437/CISPR 18-2.

#### **2 Brittle Fracture Resistance Test**

Brittle fracture test shall be carried out on naked rod along with end fitting by applying "1n HNO<sub>3</sub> acid" (63 g conc. HNO<sub>3</sub> added to 937 g water) to the rod. The rod should be held 80% of SML for the duration of the test. The rod should not fail within the 96-hour test duration. Test arrangement should ensure continuous wetting of the rod with Nitric acid.

#### **3 Recovery of Hydrophobicity & Corona test**

The test shall be carried out on 4mm thick samples of 5cm X 7cm.

- i. The surface of selected samples shall be cleaned with isopropyl alcohol. Allow the surface to dry and spray with water. Record the Hydrophobicity classification in line with STRI guide for Hydrophobicity classification. Dry the sample surface.
- ii. The sample shall be subjected to mechanical stress by bending the sample over a ground electrode. Corona is continuously generated by applying 12 kV to a needle like electrode placed 1mm above the sample surface. The test shall be done for 100 hrs.
- iii. Immediately after the corona treatment, spray the surface with water and record the HC classification. Dry the surface and repeat the corona treatment as at clause 2 above. Note HC classification. Repeat the cycle for 1000 hrs. or until an HC of 6 or 7 is obtained. Dry the sample surface.
- iv. Allow the sample to recover and repeat hydrophobicity measurement at several time intervals. Silicone rubber should recover to HC 1 – HC 2 within 24 to 48 hours, depending on the material and the intensity of the corona treatment.



#### **4 Chemical composition test for Silicon content**

The content of silicon in the composite polymer shall be evaluated by EDX (Energy Dispersion X- ray) Analysis or Thermo-gravimetric analysis. The test may be carried out at CPRI or any other NABL accredited laboratory.

## 24. Guy Strain Insulators

### 1. SCOPE

This Specification covers porcelain guy strain insulators for use in rural electrification system.

### 2. APPLICABLE STANDARDS

Unless otherwise modified in this specification, the insulators shall comply with IS: 5300-1969 or the latest version thereof.

### 3. GENERAL REQUIREMENTS

- 3.1** The porcelain insulator shall be sound, free from defects, thoroughly vitrified and smoothly glazed.
- 3.2** The design of the insulator shall be such that the stresses due to expansion and contraction in any part of the insulator shall not lead to its deterioration.
- 3.3** The glaze, unless otherwise specified, shall be brown in colour. The glaze shall cover the entire porcelain surface parts except those areas that serve as supports during firing.

### 4. TYPE OF INSULATORS

- 4.1** The standard guy strain insulators shall be of designations 'A' and 'C' as per IS:5300.
- 4.2** The recommended type of guy strain insulators for use on guy wires of overhead lines of different voltage levels are as follows :

Power Line Voltage	Designation of Insulators
415/240V	A
11000V	C
33000V	C (2 Insulators to be used in series)

### 5. DIMENSIONS

The dimensions of guy strain insulators shall be in accordance with Figs. 1 and 2.

### 6. BASIC INSULATION LEVELS

The test voltage of the insulators shall be as under :

Designation of Insulator	Dry one minute power Frequency withstand voltageKV (rms)	Wet one minute power Frequency withstand voltage KV (rms)

A	18	8
C	27	13

## 7. MECHANICAL STRENGTH

The insulators shall be suitable for the minimum failing loads specified as under:

Designation of Insulator	Minimum failing load (KN)
A	44
	88

## 8. TESTS

The insulators shall comply with the following routine, type and acceptance tests as per IS:5300.

### 8.1 Routine Test

Visual examination

### 8.2 Type Tests

- a) Visual examination
- b) Verification of dimensions
- c) Temperature cycle test
- d) Dry one-minute power-frequency voltage withstand test
- e) Wet one-minute power frequency voltage withstand test
- f) Mechanical strength test
- g) Porosity test

### 8.3 Acceptance Tests: (to be conducted in the following order)

- a) Verifications of dimensions
- b) Temperature cycle test
- c) Mechanical strength test
- d) Porosity test

## 9. MARKING

### 9.1 Each insulator shall be legibly and indelibly marked to show the following :

- a) Name or trade mark of the manufacturer
- b) Year of manufacture
- c) ISI certification mark, if any.

### 9.2 Marking on porcelain shall be applied before firing.

**10. PACKING**

All insulators shall be packed in wooden crates suitable for easy but rough handling and acceptable for rail transport. Wooden separators shall be fixed between the insulators to keep individual insulators in position without movement within the crate.

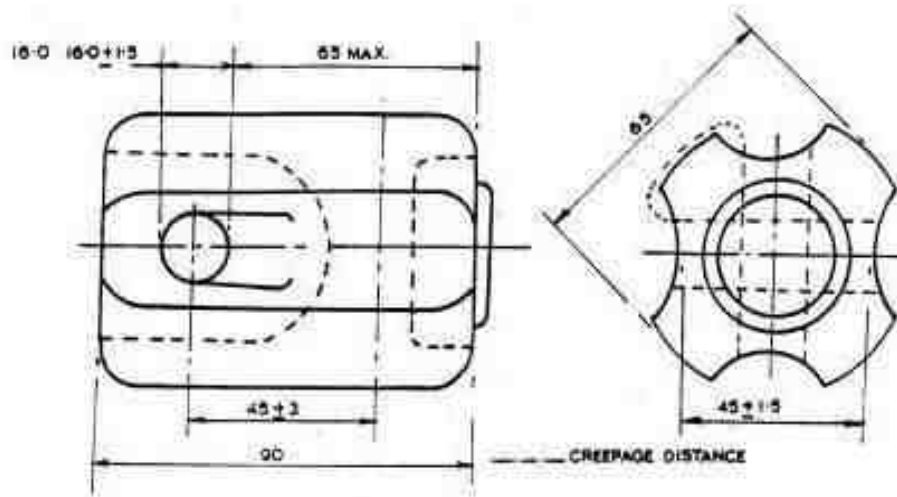

चित्र-१. तान रस्सी विकृतिसह विद्युत्रोधक - संज्ञा अ.

FIG. 1. GUY STRAIN INSULATOR (DESIGNATION - A)

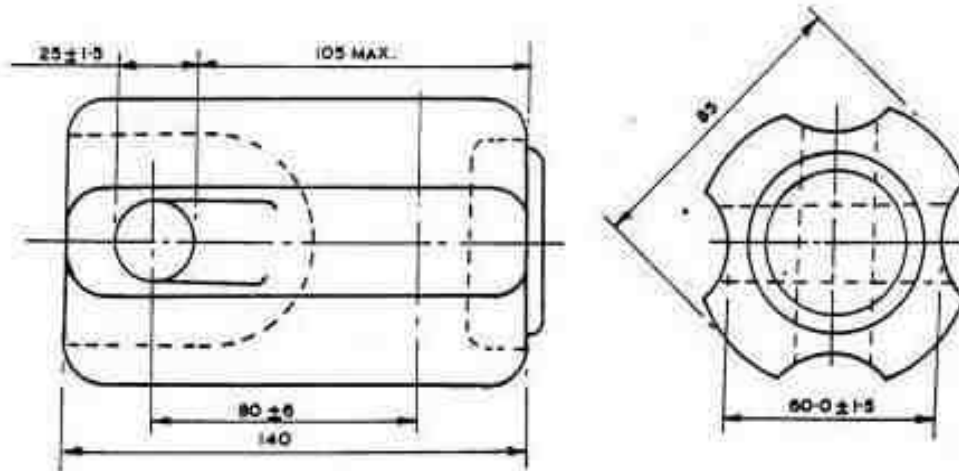

चित्र-२ तान रस्सी विकृतिसह विद्युत्रोधक - संज्ञा सी.

FIG. 2. GUY STRAIN INSULATOR (DESIGNATION - C)

## **25. Helically Formed Fittings for 11 kV and LT Lines**

### **1. SCOPE**

This Standard specifies the requirements and tests for helically formed fittings for use on 11 KV and LT overhead lines.

The following types of fittings are covered:-

- a) Conductor dead end fittings
- b) Distribution ties, side ties and double ties
- c) Conductor splices
- d) Guy grip dead-ends
- e) Tap connectors
- f) Service grip dead-ends
- g) Lashing rods

### **2. GENERAL REQUIREMENTS**

- 2.1** Aluminium alloy, aluminium-clad steel and galvanised steel wires having required mechanical strength, corrosion resistance and formability, depending on the type of application shall be employed in the manufacture of the fittings. The material of the formed fittings shall be compatible with the conductors with which it is used.
- 2.2** In case of formed wires, no joints shall be permitted except those in the base rod or wire before final drawing.
- 2.3** Each formed set shall be marked with indelible and distinct colour to indicate starting/cross-over point of application to facilitate its application on the conductor.
- 2.4** The ends of the individual wires of the formed fittings shall be suitably debarred to provide a smooth finish so as to avoid any damage to the conductor due to sharp edges.
- 2.5** Suitable grit shall be applied to the gripping section of the formed fitting (except lashing rods) in order to enhance its gripping strength.

### **3. PROPERTIES OF WIRES**

- 3.1** Materials of the wires used in the manufacture of the fittings covered by this specification shall have the mechanical and electrical properties as specified in

Tables 1,2 and 3. Materials used for chloroprene pad shall have the properties specified in Table 4.

**Table 1****Aluminium Alloy Wires**

Test	Requirements
1. Visual	a) No scratches
	b) No peeling off
	c) No speed crack
	d) No cut mark
2. Dimensions after forming	a) Diameter Tolerance (+) .000 mm (-) .025 mm
	b) Flattening (+) .000 mm (-) .076 mm
3. Tensile strength of formed wires	35 Kg/mm <sup>2</sup>
4. Elongation of finished wire	Min. 2% in a gauge length of 50 mm
5. Conductivity of finished wire	Min. 39% as per IACS
6. <u>Wrap test</u> Wire diameter mm Upto 3.07 From 3.08 to 3.45 From 3.46 to 3.71 From 3.72 to 4.24 From 4.25 and above	Min. number of twists on a mandrel of its own dia without fracture at a rate of 15 turn per minute 18 16 14 12 10

**Table 2****Aluminium Clad Steel Wires**

S.No.	Test	Requirements
1.	Visual	Free from splints, scale, inequalities, flaws and other irregularities :
2.	Dimentional	Roundness to (±) 0.013mm
3.	Tensile strength	As per table 2a below
4.	Weight of coating	As per table 2b below
5.	Wrap test (on a mandrel 2 times the dia of the sample and at the rate of 15 turns/minute)	After close helix, the sample should not fracture

6.	Adherence of coating (in a close helix not exceeding 15 turns/minute) around a cylindrical mandrel having a diameter prescribed in table 2c.	No cracking or flaking to such an extent that the aluminium coating can be removed by rabbing with the bare fingers
----	--	---

**Table 2a**

Wire diameter (mm)	Ultimate tensile strength (minimum) MPa	Ultimate elongation (Min.) percent in 254 mm
1.270 to 2.283 including	1280	3.0
2.286 to 3.045 including	1240	3.5
3.048 to 3.515 including	1210	4.0
3.518 to 3.782 including	1170	4.0
3.785 to 4.826 including	1140	4.0

**Table 2b**

Wire diameter (mm)	Min. weight of aluminium coating on uncoated wire surface (gms/m <sup>2</sup> )
1.270 to 1.521 including	70
1.524 to 1.902 including	76
1.905 to 2.283 including	79
2.286 to 2.639 including	85
2.642 to 3.045 including	92
3.048 to 3.553 including	98
3.556 to 4.569 including	104
4.572 to 4.826 including	116

**Table 2c**

Wire diameter	Min. ratio of mandrel diameter to wire diameter



1.270 to 2.283 including	3
2.286 to 3.553 including	4
3.556 to 4.826 including	5

**Table 3****Zinc coated steel wire**

	<b>Test</b>	<b>Requirements</b>
1.	Visual	Free from splints, scale, inequalities and other irregularities :
2.	Dimentional	Roundness to ( $\pm$ ) 0.013mm
3.	Tensile strength of finished wire	As per table 3a below
4.	Weight of zinc coating	As per table 3b below
5.	Wrap test (on a mandrel 2 times the dia of the sample and at the rate of 15 turns/minute)	After close helix of minimum 8 turns, the sample should not fracture.
6.	Adherence of coating (in a close helix not exceeding 15 turns/minute) around a cylindrical mandrel having a diameter prescribed in table 3c.	No cracking or flacking to such an extent that zinc coating can be removed by rabbing with the bare fingers

**Table 3 a**

<b>Wire diameter mm</b>	<b>Ultimate tensile strength (Minimum) MPa</b>	<b>Elongation in 200 mm gauge length minimum (%) mm</b>
1.270 to 2.283 including	1450	3.0
2.286 to 3.045 including	1410	3.5
3.048 to 3.053 including	1410	4.0
3.556 to 4.022 including	1380	4.0

**Table 3b**

Wire diameter (mm)	Minimum weight of zinc coating on uncoated wire surface (gms/m <sup>2</sup> )
1.270 to 1.521 including	183
1.524 to 1.902 including	198
1.905 to 2.283 including	214
2.286 to 2.639 including	229
2.642 to 3.045 including	244
3.048 to 3.553 including	259
3.556 to 4.69 including	274
4.572 to 4.822 including	305

**Table 3c**

Wire diameter (mm)	Ratio of mandrel diameter to wire diameter
1.270 to 2.283 including	3
2.286 to 3.553 including	4
3.556 to 4.822 including	5

**Table 4****Properties for Chloroprene pad**

Chloroprene cushion shall have following properties :

1a)	Tensile Strength	Minimum 100Kg/cm <sup>2</sup>
b)	Tensile strength (after ageing)	Loss of maximum 25% of the test value obtained in 1(a)
2a)	Elongation	250% minimum
b)	Elongation (after ageing)	Loss of maximum 25% of the test value obtained in 2(a)
3a)	Shore hardness 'A'	65 (±)5
b)	Shore hardness (after ageing)	(±)15% of test values obtained in 3(a)

**Note :** Ageing should be carried out for 70 hours at 100°C.

#### 4. REQUIREMENTS OF FORMED FITTINGS FOR VARIOUS APPLICATIONS

##### 4.1 Conductor Dead-end fittings

- 4.1.1** Formed conductor dead-end fitting for 11 KV lines consists of the following parts for use with disc insulators of clevis and tongue type:
- Cross arms strap for attaching the fittings to the pole on one side and the disc insulator on the other. These fittings shall conform to the REC Specifications of 11 KV Porcelain Insulators and Fitting.
  - Aluminium alloy die cast thimble clevis for attaching the fitting to the tongue of disc insulator on one end and for accomodating loop of the helically formed fitting at the other end in its smooth internal contour. The thimble clevis is attached to the insulator through a steel cotter pin used with a non-ferrous split pin of brass or stainless steel. The thimble clevis shall have clevis dimensions as per IS : 2486 (Part II) - 1989 and shall have the minimum failing load strength of 3000 kg.
  - Helically formed fitting acting as the dead-end grip.
- 4.1.2** The die-cast aluminium alloy thimble clevis shall be manufactured with alloy A6 Designation of IS : 617 - 1975.
- 4.1.3** Nuts and bolts used shall be of galvanised steel conforming to IS : 1364 - 1967 and cotter pins conforming to IS : 2004 -1978. Spring washers used shall be electro-galvanised.
- 4.1.4** The fitting for LT lines shall comprise of the helically formed fitting to suit the LT shackle insulator as per REC Specification of Porcelain Insulators and Insulator Fittings For 415/240V Overhead Power Lines
- 4.1.5** The fittings shall be made to suit the following conductor sizes for 11 KV/LT Lines conforming to REC Specification 1/1971(R-1993) and each fitting shall have a clear identification mark on PVC/metallic/plastic tag, indicating size of the conductor and voltage. The following colour code shall be used for the tag as also for the starting/cross-over marks for quick identification:

20 mm <sup>2</sup> ACSR(Squirrel)	Blue
30 mm <sup>2</sup> ACSR(Weasel)	Red
50 mm <sup>2</sup> ACSR (Rabbit)	Yellow
50 mm <sup>2</sup> ACSR (Rabbit)	Brown
50 mm <sup>2</sup> AAC (Ant)	Grey

## 4.2 Distribution ties side ties and double ties

- 4.2.1** Helically formed ties are used to hold the conductor to pin insulators or shackle insulators.]
- 4.2.2** Chloroprene pad shall be provided with the formed ties for use on 11 KV lines to avoid abrasion of the conductor
- 4.2.3** The conductor sizes and voltage class shall be clearly marked on each fitting and the fittings shall also be identified by color code as per clause 4.1.5.

**4.2.4** To ensure proper fitting of 11 KV pin insulator ties, the purchaser shall furnish full-dimensions of the insulator top particularly the crown diameter, neck diameter etc. See REC specification 11KV porcelain insulators and fittings.

### **4.3 Conductor Splices**

**4.3.1** Conductor splices for ACSR conductors shall consist of (i) galvanised steel formed splice for steel core (ii) aluminium alloy formed filler rod (iii) aluminium alloy formed splice for the aluminium strands of the conductor. For AAC conductor, splice is formed with aluminium alloy only.

**4.3.2** Repair Splice: Repair splices are non-tension splices and are used where some of the outer strands of the conductor are damaged.

### **4.4 Guy Grip Dead-End**

**4.4.1** Guy grip dead ends have one leg shorter than the other and are suitable for gripping the guy wire. These grips are applied on one side into the thimble eye of the stay rod and on the other side to the guy wire. These can also be used directly with guy insulators.

**4.4.2** The fittings shall be made of two sizes to suit stay wires of 7/3.15mm(7/10SWG) and 7/2.5 mm(7/12SWG) having UTS values 3625 kg and 2300 kg respectively.

**4.4.3** The fittings shall be clearly identified on a PVC/mettalic/plastic tag for the size of stay wire with which these are to be used and, in addition, the following colour codes for the tag as well as the corss-over marks shall be adopted for proper identification:

Guy grip for 7/3.15 mm stay wire - Green

Guy grip for 7/2.5 mm stay wire - Black

**4.4.4** The guy grip shall be supplied complete with thimble to suit the fitting. Thimble shall be made of hot-dipped galvanized steel.

**Note:** The guy grips to be used with guy insulators shall take into account the standard sizes of insulators as per REC specification and the type and size of the guy insulator shall be clearly specified by the purchaser.

**4.5** Tap Connectors: Tap connectors consist of helically formed aluminium alloy wires for non-tension tapping of conductors and cables from the main line. The

sizes of conductors/cables for which these tap connectors are to be used have to be clearly specified by the purchaser.

- 4.6** Service Grip Dead End: Service grip dead-ends are used with metallic knob to hold one or more service bearer wires.
- 4.7** Lashing Rods: Lashing rods are helically formed wires to secure the bearer wire to the service cable. The number of lashing rods will depend on the length of service.

## **5. DIMENSIONAL REQUIREMENTS OF THE FINISHED FORMED FITTINGS**

- 5.1** The lay of the helix shall be right hand.
- 5.2** The diameter and number of formed rods used per set of fittings to be used on various sizes of conductors shall be as per the approved drawings.
- 5.3** Tolerances of formed fittings: The various requirements of the helically formed fitting shall be within the following tolerances:

	<b>Item</b>	<b>Tolerances</b>
	Pitch length	+ 0.6 mm (-)0.12 mm
	Internal diameter	+ 1% (-) 3%
	Length of individual rod	(±) 1%
	Difference in length	(±) 1% between the longest and the shortest rod in an individual set

## **6. TESTS**

- 6.1 Type Tests:** The following tests shall constitute the type tests on the finished fittings:

<b>Test</b>	<b>Applicable to</b>
Visual examination	All fittings
Verification of dimension	All fittings
Tensile strength test	All fittings
Electrical resistance test	All aluminium alloy fittings
Wrapping test	All fittings
Slip strength test	Conductor dead-end, guy grip and splices
Resilience test	Conductor dead-end, guy grip and conductor splices

Unbalanced holding Strength Test	Ties only
Fatigue test	Conductor dead-end, ties and splices
Galvanising test	Hardwares and fittings using GI wire
Pull-off strength test	Ties only
Electrical & Mechanical Test	Tap Connectors

**Acceptance Test:** The following shall constitute the acceptance test:

1. Visual examination
2. Verification of dimension
3. Tensile Strength test
4. Electrical resistance test
5. Wrapping test
6. Slip Strength test
7. Resilience test
8. Unbalanced load
9. Galvanisation test
10. Pull-off strength
11. Electrical & Mechanical tests on tap connectors
12. The tests for other requirements as per Tables 1,2,3 & 4 on the individual wires used in making the helically formed fittings and chloroprene pad (where used).

**6.2 Routine Tests:** The following shall constitute the routine tests:

- a) Visual examination
- b) Verification of dimensions

## 7. TEST PROCEDURE

**7.1** Visual Examination: All fittings and individual wires shall be checked visually for good workmanship, smooth finish and other requirements indicated in Table 1, 2 and 3.

**7.2** Verification of dimensions: The dimensions shall be checked as specified in the tables 1, 2, 3 and clause 5.

**7.3** Tensile Strength Test:

**7.3.1** Individual wire of the helically formed wires shall be straightened by light hammering and tested for tensile strength and elongation in accordance within the IS:398(Part II)-1976. The tensile strength and the elongation of the formed wires shall not be less than the values specified in tables 1, 2 and 3.

**7.3.2** For thimbles and hardwares other than formed fittings:

The dead-end clevis thimble and straps shall be tested for tensile strength in accordance with the requirements of mechanical failing load as per IS:2486(Part I)-1993.

**7.4** Electrical Resistance Test: This test shall be done on straightened aluminium alloy formed wires only. The conductivity of the wires should not be less than 39% IACS.

**7.5** Wrapping Test: The individual wires of the formed fittings shall be tested as specified in tables 1, 2 and 3. The wires should not break or show fracture when tested as above.

**7.6** Slip Strength Test: For the conductor dead-end and guy grip dead-end, the test shall be made in accordance with IS:2486(Part I)-1993 and the value of slip/breaking strength shall not be less than 85% of the breaking strength of the conductor for conductor dead-end fitting and 100% for guy wires dead end fittings. In case of tension splices, the test shall be carried out as per IS:2121. No slippage or damage to the fitting shall occur at a value less than 100% of breaking load of the conductor. This test should be repeated after the resilience test.

**7.7** Resilience Test: A set of helically formed fitting is wrapped and un-wrapped on a piece of conductor 3 times successively. The helical fitting should not lose its resilience even after three applications and should be able to pass the slip strength test requirements mentioned in 7.6 thereafter.

**7.8** Unbalanced Holding test: Unbalanced holding strength is the ability of the formed ties to maintain a constant and uniform grip on the conductor when intermittent and repeated unbalanced loads impose a tension imbalance in the span. These imbalances occur due to wind induced motion, impacts, ice conditions and more so when the conductor is broken.

The test is intended to simulate the broken wire condition. A span of minimum 20 meters tensioned for 40% of UTS of the conductor shall be erected in the laboratory and a pin insulator alongwith the insulator tie under test shall be applied in the middle of span. The conductor used for this purpose shall be of the specific size with which the insulator tie is to be used. The test set up shall be such that it should be possible to apply a pull on one of the two dead ends of the conductor. For the purpose of this test, a steel replica of the insulator will be used. During the test, tension on one side of the pin insulator shall be suddenly

released and effect observed. No slippage or damage to the fitting shall occur. After releasing tension from the other end, the fitting should retain the original form. This test will not only check the holding strength of the fitting but will also prove the resilience of the fitting in the event of broken wire.

The test shall be repeated. After releasing the conductor tension on one side, pulling force shall be slowly applied on the other dead-end to pull the conductor till slippage/damage occurs. This force shall not be less than 320 kg.

- 7.9 Fatigue Test:** The fittings should be subjected to fatigue test alongwith the conductor by imparting 10 million cycles of peak to peak amplitude at a frequency above 30 cycles for minimum span length of 20 meters, at 40% of UTS of conductor. The amplitude of the vibrations at the antinodal points should be atleast 50% of the diameter of the conductor. The test should be carried out for 10 million cycles as continuously as possible after which the conductor fitting and insulator should be examined. There should be no damage to the conductor or the insulator where the fitting is attached. The fitting should also be able to withstand the test without any damage.
- 7.10 Galvanising Test:** Galvanising test should be carried out in accordance with IS:4826-1979 for uniformity and IS:6745-1972 for weight of zinc coating and the fittings will meet the requirements of Table 3.
- 7.11 Pull-Off Strength Test:** This test is intended to simulate the conductor pull-off conditions created by various factors including elevation difference of the supporting structures on the two sides of the tie. A span of minimum 20 metres tensioned for 40% of UTS of the conductor shall be erected in the laboratory with a conductor of the specified size with which the fitting is intended to be used. A steel replica of pin insulator alongwith the insulator tie under test shall be applied in the middle of span so that a suitable pull-off force can be applied on the pin by means of a machine. The pull-off strength of the tie shall not be less than 200 Kg. for all the three sizes of ACSR.
- 7.12 Electrical & Mechanical Test on Tap Connectors:** The tap Connectors shall conform to all the electrical and mechanical properties as per IS:5561.

## **8. PACKING AND MARKING**

- 8.1** All helically formed items covered under this specification shall be carefully handled to prevent distortion and damage. These items shall be packed and stored in suitable cartons.

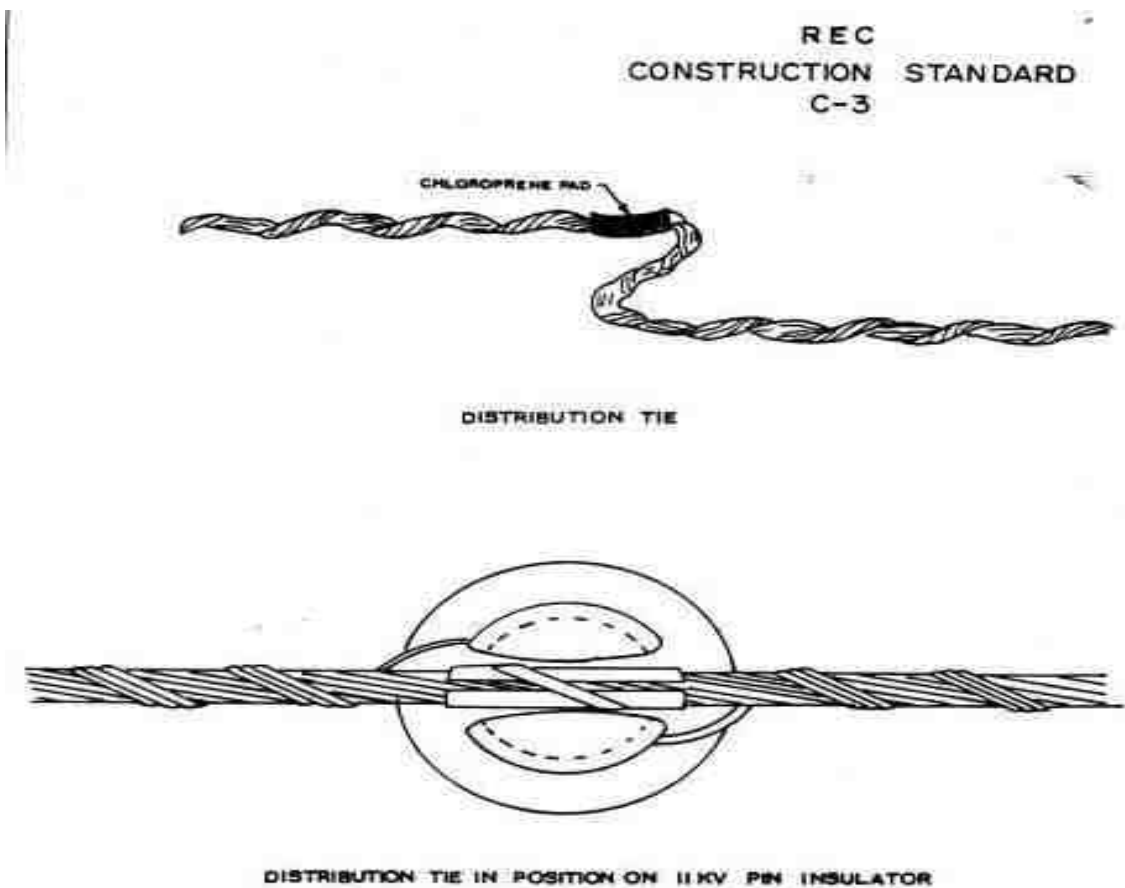

- 8.2 Different colour codes shall be adopted for different conductor sizes and catalogue number and range of outside diameter of the conductor shall be indicated on the packing.
- 8.3 Clevis thimbles and other hardware for conductor dead-ends shall be packed in wooden crates with all necessary markings.
- 8.4 The packings of the fittings should carry the following informations.
- Purchaser's name
  - Manufacturer's name and trade mark
  - Size of conductor, line voltage (when required) and numbers
  - Batch number, date, month and year of manufacture
  - Any other marking agreed to between manufacturer and user.

**NOTE**

FOR DETAILS OF HELICALLY FORMED FITTING REFER REC SPECIFICATION NO.25/1983

११ के. वी. पिन इन्सुलेटर पर कन्डक्टर स्थापित करना-स्ट्रेट-रन (सर्पिल फॉर्मिड फिटिंग का प्रयोग करना) HOLDING OF CONDUCTOR ON 11KV PIN INSULATOR-STRAIGHT RUN (USING HELICALLY FORMED FITTING)	
SCALE - N.T.S	JULY, 1984.

REC  
CONSTRUCTION STANDARD  
C-4

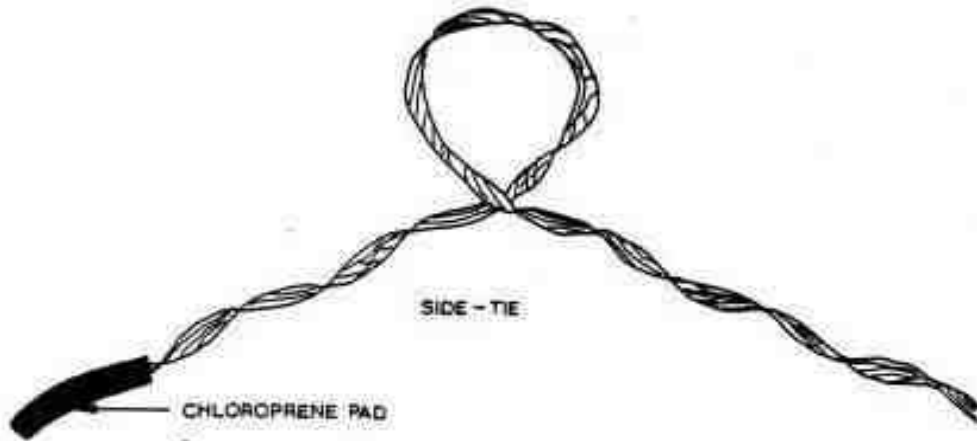

NOTE :- FOR DETAILS OF HELICALLY FORMED FITTINGS  
REFER REC SPECIFICATION NO. 25/1983.

११ के. वी. पिन इन्सुलेटर पर कन्डक्टर ध्यापित करण-समक कोणस्थान (सोपल आकार के फिटिंग फिटिंग का प्रयोग करना)	
HOLDING OF CONDUCTOR ON 11KV PIN INSULATOR - ANGLE LOCATION (USING HELICALLY FORMED FITTING)	
SCALE:-N.T.S	JULY, 1984

REC  
CONSTRUCTION STANDARD  
C-5



CONDUCTOR DEAD-END FITTING

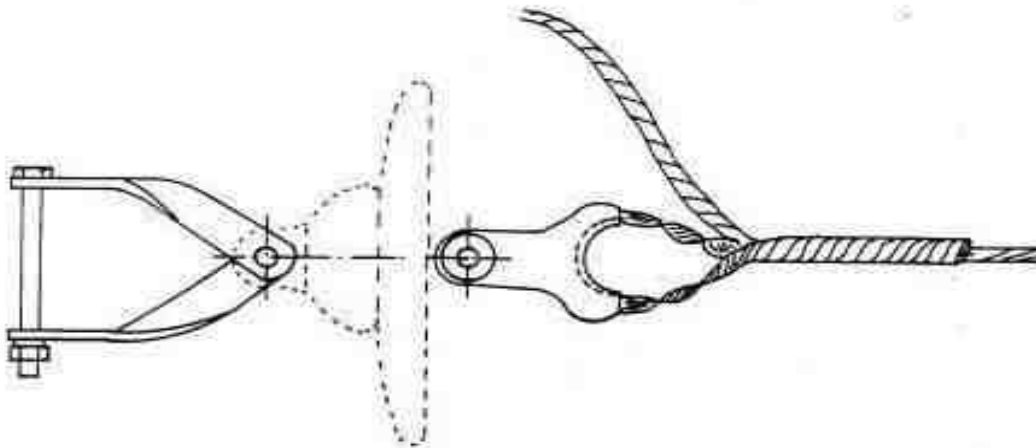

11KV CONDUCTOR DEAD-END FITTING IN POSITION

11KV STRAIN INSULATOR HARDWARE CONSIST OF:

1. HELICALLY FORMED DEAD-END FITTING
2. CLEVES THIMBLE AND
3. CROSS-ARM STRAP WITH BOLT.

**NOTE:-**

FOR DETAILS OF HELICALLY FORMED FITTING REFER  
REC SPECIFICATION NO. 25/1983

११ के. वी. कन्डक्टर अन्तिम डोर कन्डिन्सस  
(सर्पिल आकार के फॉर्मड फिटिंग का प्रयोग  
करना)

11KV CONDUCTOR DEAD-END ARRANGEMENT  
(USING HELICALLY FORMED FITTINGS)

SCALE :- N.T.S

JULY, 1984

REC  
CONSTRUCTION STANDARD  
E-31

USE OF LASHING RODS TO SECURE THE OVERHEAD BEARER WIRE AND  
THE PVC SERVICE CABLE



FIGURE-1

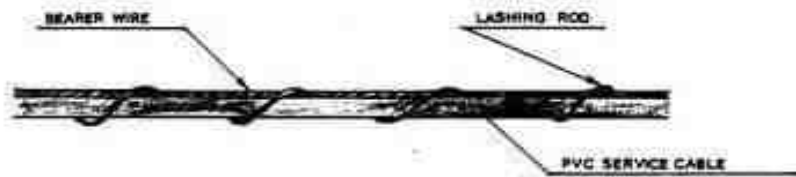

FIGURE-2

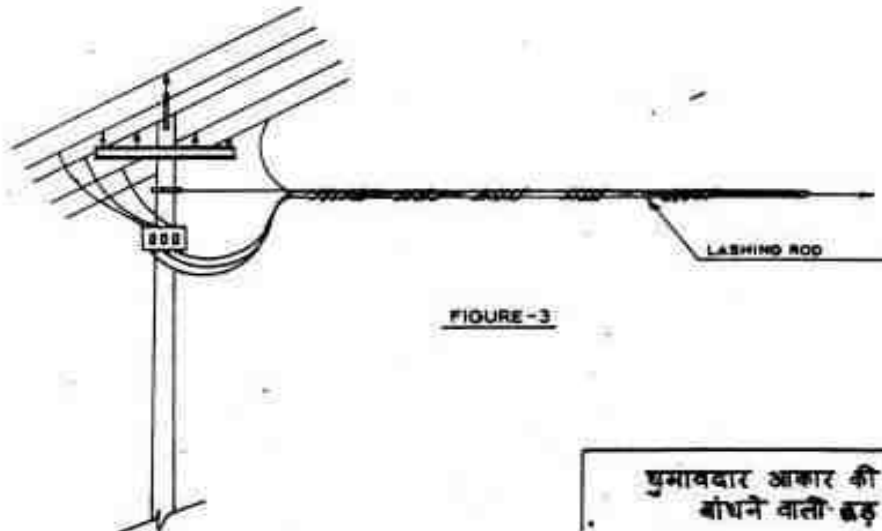

FIGURE-3

FIG-1 SHOWS THE LASHING ROD.  
FIG.2&3 SHOW THE LASHING RODS IN POSITION.

धुमावदार आकार की फिटिंग बांधने वाली छड़	
HELICALLY FORMED FITTINGS LASHING RODS	
SCALE :- N.T.S	JULY-1984

REC  
CONSTRUCTION STANDARD  
E-32

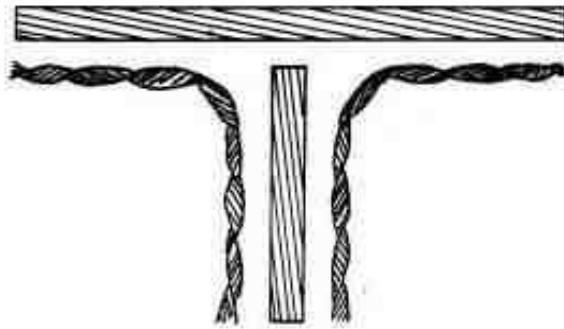

FIGURE - 1

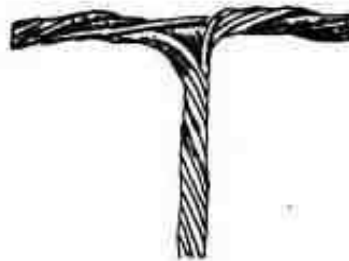

FIGURE - 2

NOTE:-

T-CONNECTORS CAN BE USED TO TAP SERVICE CONNECTIONS FROM THE LINE OR FOR TAPPING A BRANCH LINE FROM THE MAIN LINE.

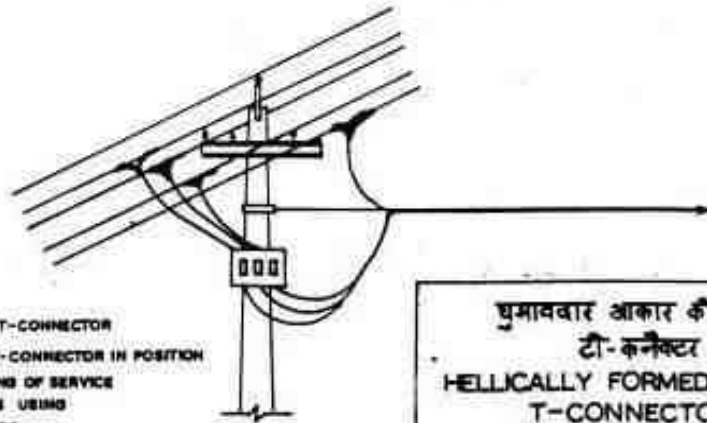

FIG.1 SHOWS THE T-CONNECTOR  
FIG.2 SHOWS THE T-CONNECTOR IN POSITION  
FIG.3 SHOWS TAPPING OF SERVICE CONNECTIONS USING T-CONNECTORS.

FIGURE - 3

घुमावदार आकार की फिटिंग टी-कनेक्टर HELICALLY FORMED FITTINGS T-CONNECTOR	
SCALE:- H.T.S	JULY - 1984

R E C  
CONSTRUCTION STANDARD  
E-33

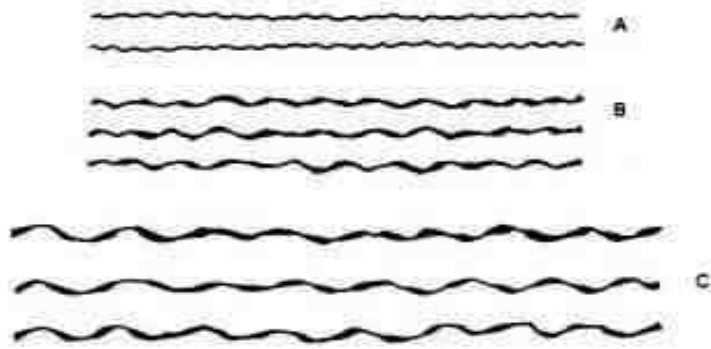

FIGURE-1

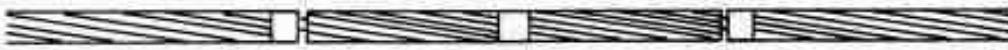

FIGURE-2



FIGURE-3

- A SHOWS THE CORE SPLICE
- B SHOWS THE FILLER RODS
- C SHOWS THE OUTER SPLICE
- FIG.1 SHOWS THE CORE SPLICE IN POSITION
- FIG.2 SHOWS THE CORE SPLICE AND FILLER RODS IN POSITION
- FIG.3 SHOWS THE COMPLETE JOINT AND THE OUTER SPLICE IN POSITION.

घुमावदार आकार की फिटिंग  
ए.सी.एस.आर. के लिए इस्तेमाल  
HELLICALLY FORMED FITTINGS  
SPLICE FOR ACSR JOINT

SCALE - N.T.S

## **26. Insulation Piercing Connectors, Anchor (Dead End) & Suspension Accessories & Other Accessories for Aerial Bunched Cables for Working Voltage upto and including 1100 Volts**

### **1.0 SCOPE**

This specification covers the design, manufacture, assembly, testing and supply of Accessories for anchoring, suspending & making connections to Aerial Bunched Cables rated 1100 volts and insulated with cross-linked polyethylene.

### **2.0 STANDARD**

The design, performance and test requirements shall confirm to this specification and the following standards. However in case of any conflict, the requirements of this specification shall prevail.

- NFC 33-020 Insulation Piercing Connectors
- NFC 33-209 LV Aerial Bunched Cables
- NFC 20-540 Environment Testing for Outdoor
- NFC 33-004 Electrical Ageing Test
- NFC 33-040 Suspension Equipments
- NFC 33-041 Anchoring Devices
- IS 14255 LV Aerial Bunched Cables

The Devices shall also be compatible with the cables of sizes & dimensions as defined in the Cable Specifications for the cables with which they are intended to be used.

### **3.0 CLIMATIC CONDITIONS**

For the purpose of designing the climatic conditions as specified in annexure-1 shall be considered.

### **4.0 CABLE DATA**

The standard sizes and characteristics of the phase and street lighting conductors, messenger wires shall be as specified in IS: 14255-1995.

The Accessories of LT XLPE Insulated Aerial Bunched Cables (ABC) with ~~insulated~~ bare messenger cum neutral are specified below:

- a) The ABC accessories should be of proven design with minimum 2 years record of satisfactory operation with a major utility. Order copies and Performance Certificates should be enclosed with the offer.

- b) Since ABC accessories are to be used with ~~insulated~~ bare neutral-cum-messenger, their design should incorporate specific features to prevent damage to the insulation which meeting the required electrical, mechanical & thermal requirements.
- c) All mechanical, electrical & thermal ratings should meet or exceed 90% of the corresponding ratings of the cable, or the values specified herein, whichever are more stringent.
- d) The accessories should provide “Double Insulation” so that a single point failure of insulation will not result in the system tripping.

## 5.0 THE ABC ACCESSORIES

The ABC Accessories shall consist of the following:

a)	Insulation Piercing Connectors (IPC)	:	For making tap-off/branch connectors/service connector to an ABC line.
b)	Anchoring Assembly (AA)	:	For fitting onto a pole for anchoring the end of a length of ABC, or for a major change in direction.
c)	Suspension Assembly (SA)	:	For supporting a length of ABC at an intermediate pole in a length, with small angle of deviation.
d)	Service clamp (sc)	:	For anchor Insulated service lines (armoured or unarmour)
e)	Transformer Connections	:	For connection to the transformer bushing.
f)	Junction Sleeves	:	For Phases, neutral messengers & Street lighting conductor.
g)	ABC Service Main Distribution Box	:	For Distribution of multiple no. of Service Connections from Main AB cable.



## 5.1 Insulation Piercing Connectors (IPC)

- 5.1.1 Insulation Piercing Connectors (IPC) are used for making Tee/Tap-off/Service connectors to an ABC/Bare Overhead Line.
- 5.1.2 Insulation Piercing Connectors are designed to make a connection between the uncut main conductor and a branch cable conductor without having to strip either cable to expose the conductor instead the tightening action of the IPC will first pierce the Insulation, then make good electrical contact between the main end and branch conductor while simultaneously insulating and sealing the connection.
- 5.1.3. Constructional Features of IPC
  - 5.1.3.1 The housing shall be made entirely of mechanical and weather resistant plastic insulation material and no metallic part outside the housing is acceptable except for the tightening bolt.
  - 5.1.3.2 Any metallic part that is exposed must not be capable of carrying a potential during or after connector installation.
  - 5.1.3.3 Screws or nuts assigned for fitting with IPC (Insulating Piercing connector), must be fitted with torque limiting shear heads to prevent over tightening or under tightening (min & max torque values to be specified by Manufacturer).
  - 5.1.3.4 The IPC must perform piercing and connection on Main and Branch cable simultaneously.
  - 5.1.3.5 The IPCs shall be water proof and the water tightness shall be ensured by appropriate elastomer materials and not by grease, gel or paste alone.
  - 5.1.3.6 Design of IPC should be such as to not cause damage to insulation of adjacent conductors due to vibration and relative movement during service.
  - 5.1.3.7 The connector shall have a rigid removable end cap which can be slide fitted onto the main connector body on either right or left by the installer (depending on site requirement) for sealing the cut end of the branch cable. Once the connector is fitted, it should not be possible to remove the cap without removing the connector.

5.1.3.8 All the metallic parts of the connector should be corrosion resistant and there should not be any appreciable change in contact resistance & temperature after overloads & load cycling.

- The contact plates should be made of tinned copper/**aluminium alloy**.
- Connector teeth should be factory greased & sealed to retard water or moisture ingress & corrosion.
- The Insulation material should be made of weather & UV resistant reinforced polymer.
- The outer metallic part should have potential free tightening bolts to allow safe installation on live lines.

#### 5.1.4 **Mechanical Tightening and Electrical Continuity**

5.1.4.1 Connectors shall be tightened upto 70% of the minimum torque indicated by the Manufacturer. At this torque electrical contact should have occurred between conductors to be joined. Then connectors shall be tightened up to the breakdown of the shear heads and lastly, upto 1.5 times the maximum torque indicated by the manufacturer.

For the connector fitted with two screws on the same core, after the breakdown of the shear heads tightening may be carried out manually and alternatively using a torque meter. The test conditions shall be as close as possible to those defined for the use of the test machine as per NF-C standard.

5.1.4.2 At 1.5 times the maximum torque indicated by the manufacturer, there shall be no breakdown of any part of the connector or the core conductor.

5.1.4.3 Maximum rated torque shall not exceed 20 N.m for conductor <95 sq.mm and 30 for >95 but <150 sq.mm.

5.1.4.4 Tightening screws shall have hex. Heads of 10 mm, 13 mm or 17 mm only.

#### 5.1.5 Effect of Tightening on Main Core of IPC

5.1.5.1 The connector shall be fitted approx. at the centre of the main core, which is secure between two anchoring points 0.5 mtr. To 1.5 mtr.apart. At the time of fitting the connectors, the main core shall be under longitudinal tension at 20% of the load indicated in Table-1:

**Table-1**

<b>Nominal Cross – section (sq.mm.)</b>	<b>Tensile Strength (Newton)</b>
16	1200

25	1800
35	2500
50	3500
70	5000
150	10000

5.1.5.2 Tensile strain shall be increased to the full value indicated in the Table 1 and held minute. There should be no breakdown of the core conductor.

#### 5.1.6 Effect of Tightening on Branch Core of IPC

5.1.6.1 Test specimen shall be made up as in clause 5.1.5.1 except that this shall be do the smallest cross sections of main and branch conductors within its range.

5.1.6.2 An increasing tensile load shall be applied to the Branch Conductor along the axis of the recess for the Branch cable. Load shall increase at 100 – 500 N/minute until it reaches the value specified in the Table 2 and maintained for 1 minute.

#### Table-2

Nominal Cross – section (sq.mm.)	Tensile Strength (Newton)
16 (Alu)	290
25	450
35 & above	500

5.1.6.3 No slippage or breaking of conductor shall occur.

#### 5.1.7 Dielectric & Water Tightness Test of IPC

5.1.7.1 The connector is tightened up to the minimum torque indicated by the manufacturer.

5.1.7.2 Connectors are mounted on

- Minimum cross section of main core.
- Maximum cross section of main core.

5.1.7.3 In each case Branch is of minimum cross section.

- 5.1.7.4 Protection caps for the branch cable are to be used in accordance with the requirements of clause 5.1.3.7. An additional water tight cap of any design may be used to seal one end of the main cable if it is immersed under water. No additional gel or any protection is to be provided while installing connector.
- 5.1.7.5 The entire assembly shall be immersed at a depth of approx. 30cms. For 30 minutes with the free ends of main and branch cable out of the water.
- 5.1.7.6 An AC voltage of 6 kV shall be applied between the water bath and each of the cores in turn for 1 minute. There shall be no flashover or electrical tripping with a trip setting of 10 mA + 0.5mA.

#### 5.1.8 Electrical & Ageing Test of IPC

- 5.1.8.1 Two test configurations are used according to Table 3 with the connections tightened to the minimum torque specified by their manufacturers and resistance recorded.

**Table - 3**

Configuration	Main core cross section	Branch core cross section Tensile Strength (K.N)
1st Configuration	Maximum	Maximum
2nd Configuration	Maximum	Maximum

- 5.1.8.2 The configurations are subjected to 200 heat cycles by injecting suitable current into them. In each cycle the temperature of the conductor shall be raised from ambient to 120 + 5°C as, measured by a thermocouple.
- 5.1.8.3 The duration of each heating cycle is chosen to maintain a sufficiently steady temperature of 120 + 5°C for 15 minutes. The duration of each cooling cycle is chosen to bring the conductor temperature to within 2°C of ambient.
- 5.1.8.4 Nominal heating current is indicated in the Table-4. It shall be permissible to accelerate the temperature rise by using a current up to 1.5 times the nominal current and to accelerate the cooling period by use of a fan or air blower.

**Table-4**

Nominal Cross – section (sq.mm.)	Nominal Heating Current (A)
16	102
25	139

35	175
50	225
70	283
95	350
120	412
150	480
185	545
240	670

5.1.8.5 The over current test of Clause 5.1.9 shall be done after 50 cycles if the connector is a safety connector designed to ground a phase connector while the line is being worked on.

5.1.8.6 At the end of the 200 cycles the resistance shall again be measured. It shall not differ from the initial value by more than 12%.

#### 5.1.9 **Over Current Test of IPC**

5.1.9.1 Over current test is required to establish the performance of Safety Connectors that are intended to provide a safe path to ground for the phases while the line is de-energised for working. It establishes the performance of the connector under short term over load conditions.

5.1.9.2 After the first 50 cycles of clause 5.1.8, the connectors are subjected to 4 over currents of 1 sec duration each.

5.1.9.3 The conductor temperature at the start of the over current test should be not more than 35°C.

5.1.9.4 Current density during over current shall be 100 A/sq.mm for Aluminium and 95 A/sq.mm for Aluminium – Alloy Conductor.

5.1.9.5 Variation in time of over current is permissible between 0.85 sec & 1.15 sec., provided if maintains the relationship  $I^2$

$$t = K \text{ where,}$$

$I$  = rms value of over current in Amps.

$t$  = time in seconds

$K$  = Constant

5.1.9.6 After the over current test the electrical ageing test of clause 5.1.8 shall be resumed.

#### 5.1.10 **Type Test of IPC**

5.1.10.1 Type Test Reports should be submitted from an Independent Laboratory of Repute or the Works Laboratory in case of a foreign manufacturer covering the following (on any convenient size of fitting of same design made from the same materials).

5.1.10.2 The installation of the connectors shall be done by the laboratory following instructions provided by the manufacturer.

5.1.10.3 The Test report shall record the embossing and marking on the connector.

5.1.10.4 The following shall constitute Type Tests for IPC :

- Electrical Ageing Test
- Dielectric and Water Tightness Test.
- Mechanical Tightening Test
- Effect of Tightening on main Core
- Effect of Tightening on Branch core
- Over-current Test (Applicable as per relevant clause of latest version of NFC 33020)\*

The following shall be Type Test for Suspension Assembly (SA)

- Mechanical Test
- Voltage Test
- Climatic Aging Test
- Corrosion Test
- Endurance Test under Thermal & Mechanical Stresses (optional till testing facilities are available in India)\*

The following shall be Type Tests for Anchoring Assemblies (AA)

- Mechanical Test
- Voltage Test
- Dynamic Test (Applicable for areas having subzero minimum temperature)\*
- Climatic Aging Test
- Corrosion Test
- Endurance Test under Thermal & Mechanical Stresses

## 5.2 Anchoring Clamp for Insulated Messenger:

The clamps should be designed to Anchor LT-AB cable with insulated messenger. The clamp should consists of an Aluminium alloy corrosion resistant castled body, bail of stainless steel and self adjusting plastic wedges which shall anchor/hold the neutral messenger without damaging the insulation.

**\*Amendment issued vide letter No. REC/DDUGJY/SBD/2017-18/609 dated 05.10.2018**

- No losable part in the process of clamping arrangement
- The clamp should conform to the standard NFC 33041 and 33042 or equivalent I.S. if any.
- The clamp body should be made of corrosion resistant Alluminium alloy, bail should be of stainless steel and wedges should be weather and UV resistant polymer.
- ~~Ultimate tensile strength of the clamp should not be less than 15 kN for 50/70sq.mm insulated messenger wire / 10 KN for 25/35 sq.mm insulated messenger wire.~~
- ~~Slip load of the clamp should not be less than 3 KN for 50/70 sq.mm messenger wire / 2 KN for 25/35 sq.mm messenger wire.~~ **Ultimate tensile strength of the clamp should be as per Table-6 of Technical Specification. \***

5.2.1 Anchoring assemblies are used to firmly attach the messenger of ABC to a support and transmit the mechanical tension.

- at the end of a run or to the supporting structures
- at a major change in direction.

5.2.2 Each Anchoring Assembly shall include.

- One number tension bracket.
- One number wedge type tension clamp
- Flexible Rope for fixing tension clamp to bracket.

5.2.3 Anchoring assemblies shall be supplied in sets to ensure compatibility of the materials against corrosion or wear of moving parts.

5.2.1 Tension Bracket of AA

5.2.4.1 The tension bracket shall be made out of a single piece of Aluminium alloy suitable for attachment to a pole either by

- a) 16mm galvanized steel bolt (s) or
- b) two stainless Steel straps of 20 x 0.7 mm.

5.2.4.2 The tension bracket should be designed to ensure the Flexible rope cannot slip out at any angle.

- 5.2.4.3 The tension bracket should be rated and tested for the loads specified in Table-5. The load shall be applied at an angle of 45° from the normal to the surface of mounting of the bracket.

**Table - 5**

<b>Conductor Size (Sq.mm.)</b>	<b>Rating</b>	<b>Load for deformation &lt;10mm (Newtons)</b>	<b>Load for deformation &lt;30mm &amp; no-break (Newtons)</b>
25-35	500 Kg.	12,000	15,000
50-95	.000Kg	15,600	19,500

5.2.5 Flexible Rope of AA

- 5.2.5.1 The Anchoring assembly shall be supplied with a stainless steel flexible Rope to connect the Tension Clamp to the Tension Bracket.

- 5.2.5.2 The rope should have sufficient flexibility to ease the torsional movement of the ABC System.

- 5.2.5.3 The Rope should be pre-fitted with compression type end fittings to secure the tension clamp.

**\*Amendment issued vide letter No. REC/DDUGJY/SBD/2017-18/609 dated 05.10.2018**

- 5.2.5.4 A wear resistant moveable saddle should be un-loosably fitted on the Rope to prevent abrasion at the point of fitting into the tension bracket.

- 5.2.5.5 The Rope should have sufficient mechanical strength to withstand the mechanical test for the complete assembly tests in this specification.

5.2.6 Wedge Type Tension Clamp of AA

- 5.2.6.1 Wedge type clamps shall be used for clamping the messenger without damaging the insulation.

- 5.2.6.2 The clamp shall be capable of clamping an uncut messenger so that it can continue without break to the connecting point or next span.

- 5.2.6.3 The clamp shall be fully insulating type of mechanical and weather resisting thermoplastic.

- 5.2.6.4 No bolts or loose parts are allowed as part of the Clamping system.



- 5.2.6.5 No tools shall be needed for fitting the messenger into the clamp.
- 5.2.6.6 The clamp shall be self tightening and capable of holding without slippage the load specified in the Table-6.

**Table - 6**

Conductor Size		Rating (Kg.)	T start (1	final
Sq. mm.	Dia. (mm)		minute)	1 minute)
			(Newtons)	Newtons)
25-35	8-11	1000 Kg.	8,000	10,000
50-54	8-11	1500 Kg.	12,000	15,000
70-95	13.5-16	2000 Kg.	12,000	15,000

- 5.2.6.7 After fitting the insulated messenger in the clamp, load T start will be held for 1 minute & then load increased to T final at rate between 5000 – 7,500 N/mtr. In each case there shall be no breakdown of any part of clamp and slippage of messenger in relation to the clamp.

#### 5.2.7 Voltage Test on Clamp of AA

- 5.2.7.1 Voltage test is carried out on anchor clamps to ensure no damage is caused to the insulated messenger.
- 5.2.7.2 A conductive rod of dia. corresponding to the average dia. that can be accommodated in the clamp is fitted into the clamp, protruding by approx. 50mm at each end of the tightening piece.
- 5.2.7.3 The rod and clamp is subjected to tensile load as stated in Table 7 below when fixed to a support in its normal manner.

**Table - 7**

Conductor Size		Normal rating	Load Applied (N)
Sq. mm.	Dia. (mm)		
25-35	8-11	1000 (kg)	2000
50-54	8-11	1500	4000
70-95	13.5-16	2000	4000

- 5.2.7.4 A power frequency voltage of 6 kV is applied for 1 minute between the rod and conductive part of the clamp, or fixation point in absence of conductive part.

5.2.7.5 No breakdown or flashover shall occur. There shall be no tripping due to leakage with a setting of  $10 + 0.5$  mA.

## 5.2.8 Endurance under Mechanical & Thermal Stress of AA

5.2.8.1 This test is done on clamp rated 1500 Kg. or 2000 Kg. using insulated messenger 50 to 70 sq. mm.

5.2.8.2 A neutral messenger is fitted between two anchor clamps, with clamp spacing approx. 5 mtr. & 1 mtr. Of messenger protruding from the end. Marks are made to enable measurement of slippage.

5.2.8.3 The sample is subjected to 500 cycles of 90 minutes each as described below:

5.2.8.3.1 Messenger temperature is raised by passing an AC current to  $60 + 30$  C within 15 minutes. This temperature is maintained for at least 30 minutes to give a total heating period of 45 mts.per cycle.

5.2.8.3.2 Messenger is allowed to cool naturally to ambient for further 45 minutes to complete 90mts. Cycle time.

5.2.8.3.3 Mechanical load is applied during the cycle as per table 8 below. Load F1 is applied throughout the cycle, except for a short period of 5 sec. to 60 sec. when it is gradually increased from F1 to F2 at any time during the last 15 minutes of the 90 minute cycle.

**Table - 8**

Conductor Size		Rating (Kg.)	F1 (Newtons)	F2 (Newtons)
Sq. mm.	a. (mm)			
25-35	8-11	1000 Kg.	2,200	5,000
50-54	8-11	1500 Kg.	4,000	7,500
70-95	13.5-16	2000 Kg.	4,500	10,000

5.2.8.3.4 There should be no slippage greater than 4 mm after 2 cycles or greater than 8 mm after 500 cycles.

5.2.8.3.5 Voltage test is done at the end of the 500 cycles by immersing the test specimen of neutral messenger and clamps in water of resistivity not less than 200 Ohm mtr. For 30 minutes.

5.2.8.3.6 A voltage of 10 kV ac is applied for 1 minute between messenger and water bath using a trip setting of  $10 + 0.5$  am. There should be no breakdown or tripping.

5.3 Suspension clamp for insulated neutral messenger:

The clamp should be designed to hang L.T – AB cable with insulated neutral messengers. The neutral messengers should be fixed by an adjustable grip device. A movable link should allow longitudinal and transversal movement of the clamp body.

- No losable part in the process of clamping arrangement.
- The clamp should conform to the standard NFC 33040 or equivalent I.S, if any.
- The clamp and the link made of Polymer should provide an additional insulation between the cable and the pole.
- The clamps and movable links should be made of weather and UV resistant glass fibre reinforced polymer.
- Clamps should be fixed with pole by eye hook / bracket. Bracket should be made of corrosion resistant alluminium alloy.
- ~~Ultimate tensile strength of the clamp should not be less than 15 KN for 50/70 sq.mm. Insulated messenger wire 4.3 KN for 25/35 sq.mm. Insulated messenger wire.~~
- ~~Maximum allowable load of the clamp should not be less than 20 KN for 50/70 sq.mm. insulated messenger wire/15 KN for 25/30 sq.mm insulated messenger wire.~~ **Ultimate tensile strength of the clamp should be as per Table-10 of Technical Specification.**

**\*Amendment issued vide letter No. REC/DDUGJY/SBD/2017-18/609 dated 05.10.2018**

5.3.1 Suspension Assembly is used for supporting an ABC by installation on the messenger at an intermediate point of support such as a pole. It can accommodate small angles of deviation upto 30°.

5.3.2 Each Suspension Assembly shall consist of:

- One number Suspension Bracket.
- One number moveable (articulated) connecting link.
- One number Suspension Clamp.

5.3.3 Suspension Assemblies shall be supplied in sets to ensure compatibility of the materials against corrosion or wear of rotating/moving parts.

5.3.4 Suspension Bracket of SA

5.3.4.1 The Suspension Bracket shall be made from single piece alluminium alloy suitable for attachment to a pole by either.

- a) 16 mm galvanized steel bolt or
- b) Two stainless steel straps.

5.3.4.2 The Suspension Bracket shall be provided with an upper bulge to prevent the clamp from turning over on the Bracket for more than 45° from the horizontal or to within less than 60 mm from the pole / fixing structure.

5.3.4.3 The Suspension Bracket should be so designed to ensure that the articulated link cannot slip out of it.

5.3.4.4 Suspension Brackets shall be designed to withstand a load applied at the anchoring point of the movable link as per Table – 9 below without deformation of more than 10mm or breakdown at 330° below horizontal (there should be no longitudinal component of load parallel to the plane of fixing).

**Table - 9**

Conductor Size		Normal	Load
Sq. mm.	Dia. (mm)	rating	(N)
		(kg)	
25-35	8-11	1500Kg.	12500
70-95	13-17	2000Kg.	14000

5.3.5 Movable (Articulated) Link of SA

5.3.5.1 Movable Links are used between the Suspension Bracket and Suspension Clamp to allow a degree of movement and flexibility between the two.

5.3.5.2 Moveable Links should be made fully of insulating type of mechanical and weather resistant thermoplastic. A metallic wear resistant ring should however be fitted at point of contact between the Suspension Bracket and the movable link.

5.3.5.3 The Movable link should be unloosably fitted to the Bracket and the Clamp.

5.3.6 Suspension Clamp of SA

5.3.6.1 Suspension Clamps are used for locking the messenger of the ABC bundle without damaging the insulation or allowing the messenger to become dismounted from the fitting.

5.3.6.2 The Suspension Clamp shall accommodate messenger wires from 25 to 95 sq.m.

- 5.3.6.3 The Suspension Clamp shall be made fully of insulating type of mechanically strong and weather resistant plastic.
- 5.3.6.4 Bolts should not be used for clamping / locking the messenger in the Clamp.
- 5.3.6.5 There shall be no losable parts in the Suspension clamp.
- 5.3.6.6 The Suspension Clamp should be unloosably fitted to the rest of the Suspension Assembly.
- 5.3.7 Mechanical Test on Clamp of SA
- 5.3.7.1 The Sub Assembly shall be subjected to a vertical load applied as per drawing in accordance with Table-10. There shall be no breakdown or permanent deformation at load T initial for 1 minute or when the load is increased to T final and released.

**Table - 10**

Conductor Size		Rating (Kg.)	T start	T final
Sq. mm.	Dia. (mm)		(I minute)	(I minute)
			(Newtons)	(Newtons)
25-54	8-15	1500 Kg.	9,600	12,000
70-95	13-17	2000 Kg.	12,800	16,000

Fig. : A

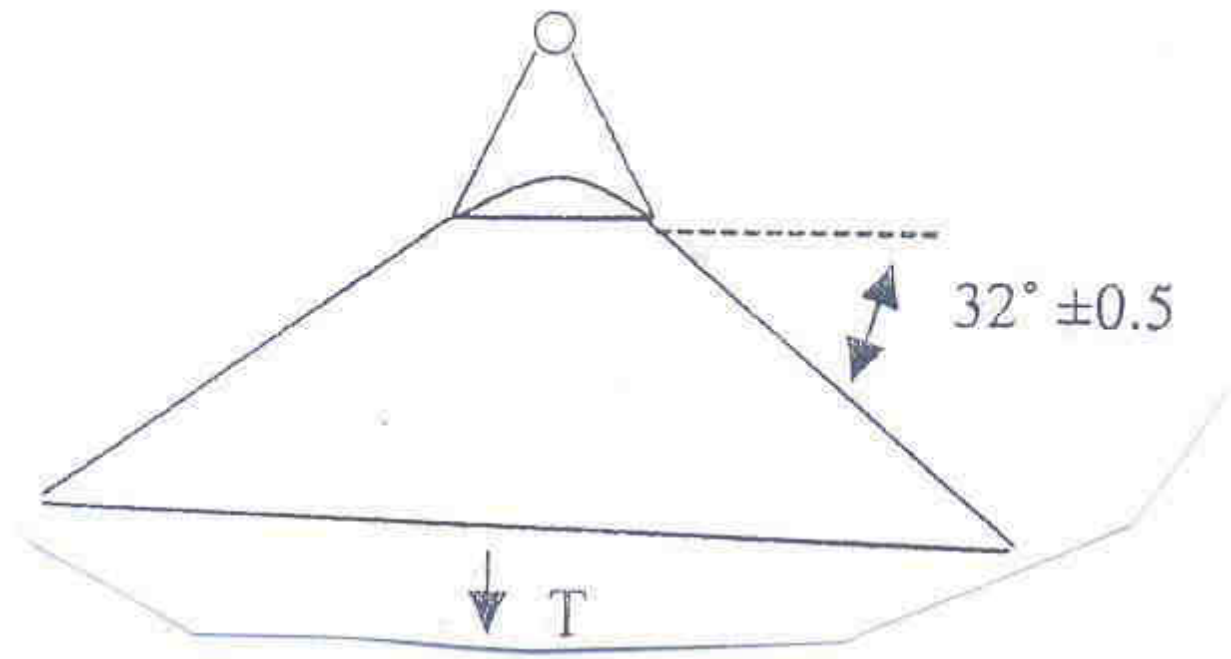

5.3.7.2 A sample messenger shall be fitted into a fixed suspension clamp and subjected to a gradually applied longitudinal load of 300 N. There shall be no permanent slip page.

#### 5.3.8 Voltage Test of SA

A copper foil is wrapped at the clamping point around the maximum size of messenger allowed in that clamp. An ac voltage of 6 KV is applied between the copper foil and nearest conductive point of the clamp or into its absence to the point of fixation. The voltage should be withstood for 1 minute without breakdown or flashover.

#### 5.3.9 Test Under Mechanical & Thermal Stress

5.3.9.1 The test specimen is made up of approx. 10mts. Of messenger wire strung between two anchor clamps with a Suspension Clamp fixed in the middle. Masses of 40 Kg. are suspended at a distance of 1-2mtr. On either side of the Suspension Clamp with a fixing mechanism of mass 2 + 1 Kg.

5.3.9.2 The specimen is subjected to 500 cycles of 90 minutes each. Each cycle consists of the following:

- a) For first 75 minutes a constant longitudinal tension of 4000 N is applied to the messenger for rating of 1500 Kg. and of 4500 N rating of 2000 Kg. while 64cycles right and left oscillation are produced on the clamp 32°on either side of the vertical.
- b) During the first 45 minutes an intermittent current of 4-5 A/sq.mm is applied to maintain the conductor temp at  $60 + 3^{\circ}$  C.
- c) During the next 45 minutes of the cycle the conductor is allowed to cool down naturally to the ambient.
- d) At the 75th minute, after having completed 64 oscillations, the oscillations are stopped and the longitudinal tension is increased to 7500 N for 1500 kg. Rating and 10000 N for 2000 Kg. Rating.

3.9.3 No messenger slippage should occur within the Suspension Clamp during the 500cycles.

5.3.9.4 At the end of the 500 cycles, the messenger is immersed in water for 30 minutes. It is then tested to withstand 10 kV ac for 1 minute with a trip setting of  $10 + 0.5$  mA. There should be no breakdown or flashover.

## 5.4 Acceptance Tests

5.4.1 The following shall constitute Acceptance Tests for Insulation Piercing Connectors(IPC) :

- Visual \*
- Dimensional (as per SCD and overall dimensions submitted with Tender Offer)\*
- ~~Electrical Ageing Test \*\*\*~~
- Dielectric and Water Tightness Test. \*\*
- Mechanical Tightening Test \*\*
- Effect of Tightening on Main Core \*\*
- Effect of Tightening on Branch Core \*\*

The above tests are to be carried out as per sampling plan below. ~~However electrical ageing test on IPC (market\*\*\*) is to be done on only one connector of each type and size.~~

In case of random failure/defect, double the sample lot is to be drawn and there should be no failure/defect exceeding half the permissible defects (rounded down) shown in the chart.

Lot Size	For tests Marked*		For tests Marked**	
	Sample Size	Max. permissible Defects	Sample Size	Max. permissible Defects
Upto 100	2	nil	2	nil
101 to 1000	6	nil	4	nil
>1001	0.01% subject to min. 6 pieces	0.1% of pieces checked	4	nil

5.4.2 The following shall constitute acceptance tests for Anchor Assemblies:

- Visual \*
- Dimensional (as per SCD and overall dimensions submitted with Tender Offer)\*
- Mechanical Test on Bracket\*\*
- Mechanical Test on Clamp \*\*
- Voltage Test \*

5.4.3 The following shall constitute acceptance tests for Suspension Assemblies:

- Visual \*
- Dimensional (as per SCD and overall dimensions submitted with Tender Offer)\*
- Mechanical Test on Bracket\*\*
- Mechanical Test on Clamp \*\*
- Voltage Test \*

The above tests (for AA & SA) are to be carried out as per sampling plan below. In case of random failure/defect, double the sample lot is to be drawn and there should be no failure/defect exceeding half the permissible defects (rounded down) shown in the chart.

Lot Size	For tests Marked*		For tests Marked**	
	Sample Size	Max. permissible Defects	Sample Size	Max. permissible Defects
Upto 100	2	nil	1	nil



101 - 500	5	1	2	nil
501 - 2500	10	2	2	nil
2501 & above	10 + 0.2 %	2 + 10% addl. Sample quantity	pf 4	1

## 6.0 SERVICE CLAMP

The clamps should be designed to anchor insulated service lines (armoured or unarmoured) with 2/4 conductors.

- The clamps should be made of weather and UV resistant polymer.
- No losable part in the process of clamping arrangement
- The clamp should conform to the standard NFC 33042 or equivalent I.S., if any. No losable
- Breaking Load of the clamp should not be less than 3 KN.

## 7.0 TRANSFORMER CONNECTION

- The connection to the transformer should be made with Pre-Insulated lugs for phase and street lighting conductors and with an Aluminum Lug for neutral Messenger. If the Bus-bars are of copper, the Lugs should be preferably Bi-metallic type.
- The Barrel of the lug normally insulated with an Anti-UV black Thermoplastic tube sealed with a flexible ring. Die reference, size and strip length are to be indicated on the plastic.
- Sizes covered 16-70 & upto 150 m<sup>2</sup> Aluminium XLPE insulated cable.
- Reference standard NFC 33021 or equivalent I.S. if any.

## 8.0 JUNCTION SLEEVES

- The sleeves should be Pre-Insulated for phases, neutral messengers and street lighting conductors.
- Sleeve should be made of Aluminum, insulated with an Anti-UV black thermoplastic tube hermetically sealed two ends with 2 flexible rings.
- Die reference, size and strip length are indicated on the sleeve itself.
- Sizes needed : 16-70 & upto 150 mm<sup>2</sup> for Aluminum XLPE insulated cable.
- Reference standard : NFC 33021 or equivalent I.S. if any.
- Design as per furnished drawing.

## 9.0 EYE HOOKS

- Eye looks should be designed as to hold suspension clamps and Dead end clamps and to be installed with the pole clamp.
- Eye-hooks should be made of forged Galvanized steel.
- The clamps corrosion resistance should conform the standards I.S. 2629 & I.S.2633.
- Bolts and nuts should be made of hot dip Galvanized steel according to VDE 0210 and VDE 0212.
- Ultimate Tensile strength (UTs) of the clamp should 20 KN.
- Design as per furnished drawing.

## **10.0 SERVICE MAIN DISTRIBUTION BOXES**

### **10.1 Scope**

This Distribution Box should be Weather & Moisture Proof with Spring loaded/Bolt& Nut type Bus Bar system & should be able to carry a current according to specified capacity. It can have 1/3-phase input & provision of 4 to 6 nos. of 3-phase or 1-phase outputs. The box should have the provision for special key for locking & Proper arrangement of sealing. The boxes should be assembled on the pole using Metal Tapes & Buckles or Bolts. No. of Boxes per pole may vary with supporting arrangement for more no. of service connections. The Spring used should be of stainless steel having required capacity to provide suitable pressure in the connector.

### **10.2 Construction**

Distribution Boxes should be designed with Bus Bars with spring action contact, or screw-bolt technique. For spring action contact only insertion of the conductor into the specified groove of the Busbar is sufficient for proper connection whereas for Nut Bolt type proper washers & other accessories are to be provided for connections. It should be used for multiple connections (3-phase or 1-phase) in low voltage Distribution Network. The boxes should be suitable for 1/3-phase (4 crores) inputs & provision for 4 to 6 nos. of 3-phase or 1-phase outputs. Bus bars should be with a continuous pair of contact bars with colour code to facilitate the identification of the correct energy phase.

The box should be able to incorporate the input or output cable dia. Of maximum 16mm. (Equivalent to 120Sq.mm.).

The Boxes should consist of special type Lock & key system as well as provision for sealing for complete protection of the service connection contacts.

### **10.3 Current Ratings**

The maximum current rating should be 140A/200A/250A & concerned authority should have the liberty to choose among the above ratings as per their requirement.

#### **10.4 Voltage Ratings:**

The maximum voltage withstand capacity should be 600V.

#### **10.5 Working Temp**

Safe working temperature should be around 80 C for Outer Box & 100OC for metallic

Bus bars.

#### **10.6 Materials**

Material used in the manufacturing process of the components of this product should be specified in the respective product drawings & can be summarized as follows :

- Outer Box (Base & Cap) : With UV protection & Flame retardant characteristics(HB, as per UL 94-Tests for Flammability of Plastic materials) & preferably made up of ASA (Achylonitrile Styrene Acrylate).
- Cable Grommets : Ethyelene-Propylene Rubber :
- Safety Key : PA 6.6 (Nylon).
- Safety Screw : Stainless Steel or Plating Finished steel.
- Insulation protection as per IP 44.
- Bus bars or Terminal Blocks : PA 6.6 (Nylon), Stainless Steel & Copper.
- Button & Cable Holder : PA 6.6 (Nylon) with 50% Glass Fibre.
- Busbar Insulation :Polymide.

#### **10.7 Locking System**

The boxes should consist of Special type Lock & Key arrangement as well as provision for sealing for complete protection of the service connection contacts.

#### **11.0 G.A. DRAWINGS ETC.**

**11.1** A drawing / picture clearly showing principal parts & dimensions for all products should be submitted along with the offer.

**11.2** The principal outer dimensions of each item, l x b x w in mm and weight in gms should be submitted along with the offer.

**11.3** The Employer may call for samples for verification & evaluation purposes.

**12.0 GENERAL CONDITIONS OF MANUFACTURE**

**13.0 GTP**

The Guaranteed Technical Particulars should be filled up in the given format of GTP.

**14.0 TESTING STANDARD – Given in Annexure 2 & 3.**

Note : 1) Any specific meteorological data other than those listed above applicable for a particular equipment/item will be available in the technical specification for that equipment/item.

2) When values specified above contradicts with respective equipment TS, the later will prevail for that equipment.

3) The atmosphere in the area is laden with industrial and town gases and smoke with dust in suspension during the dry months and subject to tough colder months.

4) Heavy lightning is usual in the area during the months from May to November.

**ANNEXURE-1****GENERAL CONDITIONS FOR MANUFACTURE**

The products shall be in accordance recognized standards used in L.T. ABC or equivalent I.S., if any.

- Marking : Each product shall be clearly identified with manufacturer name or trade mark, reference and capacity of the item and batch no.
- Packaging : Manufacturer shall mention the packaging of each item. Installation instruction should be included in packaging.
- Type test : Each supplier should provide type test reports with the offer, carried out in accordance with one of the reference standards in NABL Accredited Laboratory.
- Routine test : Supplier shall provide a control plan, which will be implemented on each item. Routine test reports should be submitted by the manufacturer with inspection call.
- Quality : All suppliers should preferably be ISO-9000 certified.

Anchoring and suspension clamps should be installable on existing poles using appropriate devices (hooks, pigtails, brackets etc.).

All crimped connectors should be installed with mechanical or hydraulic hand crimping tools.

**ANNEXURE – 2****TESTING STANDARDS :**

The Insulating Piercing Connector should conform to following std. :

<b>Tests</b>	<b>Tests Standard / Test Procedure</b>
Corrosion  Qualification Test	<p>As per NF C 33-020 (Jun '98), or equivalent I.S., if any.</p> <p>Exposure in Saline Environment : The exposure should be carried out as per NF en 60068-2-11 (Aug. '99) std. requirement. The concentration of Saline solution must be of 5% <math>\pm</math> 1% in mass, &amp; the temperature of the test chamber must be maintained at 35°C <math>\pm</math> 2°C.</p> <p>Exposure in Sulphur environment saturated of humidity – The exposure should be carried out as per NF T 30-055 (Mar. '74) std. requirement. SO<sub>2</sub> concentration in the chamber should be 0.067% in volume. The temperature of the test chamber should be increased to 40°C <math>\pm</math> 3°C.</p> <p>The total test should include four identical periods of 14 days, in which 7 days of exposure in Saline environment &amp; in other 7 days – 8 hrs. cycles in SO<sub>2</sub> environment &amp; 16 hrs. in laboratory environment.</p>
Electrical Ageing Test	<p>As per NF C 33-020 &amp; NF C 33-004 (Jun '98) or equivalent I.S., if any.</p> <p>Total no. of cycles 200, Heating time -60 mins., Cooling time - 45 mins., Pause time – 2 mins.</p>
Dielectric Investigation Test in water	<p>As per NF C 33-020 (Jun '98) or equivalent I.S., if any. 15°C &amp; 30°C &amp; relative humidity between 25% &amp; 75%. The tightening of the connectors should be at minimal value of the torque indicated by the manufacturer. The sample should be placed in tank full of water on 30 cm height, after an immersion length of 30 mins. The set is subjected to a dielectric test under a voltage of 6 KV at industrial frequency during 1 min. No flashover / breakdown should occur at 6 KV during 1 min.</p>

Tests	Tests Standard / Test Procedure
<b>Tests</b>	<b>Tests Standard / Test Procedure</b>
Mechanical Tests	As per NF C 33-020 (Jun '98) or equivalent I.S., if any. For checking electrical continuity, shear heads & mechanical behaviour of the connector's suitable tests as per the above specification have to conduct.

**Capacity needed :**

For ABC 16 to 95 mm<sup>2</sup>

Model 1 for customer service

Main 16 to 95 mm<sup>2</sup>

Tap 2.5 to 10 mm<sup>2</sup> (For Street lighting/service connection)

Design as per furnished drawing

Model 2 for customer service

Main 16 to 95 mm<sup>2</sup>

Tap 04 to 35 mm<sup>2</sup> (for distribution box charging)

Design as per furnished drawing

Model 3 for customer service

Main 25 to 95 mm<sup>2</sup>

Tap 25 to 95 mm<sup>2</sup> (For ABC to ABC Tee Joint)

Design as per furnished drawing.

**ANNEXURE – 3****TESTING STANDARDS**

Impact Resistance should be according to UL 746C. Insulation Protection should be as per IP 44. The Outer Plastic box should conform to following std. –

<b>Test / Standard</b>	<b>Requirements</b>	<b>Test Procedures</b>
Degree of Protection IEC 60529	IP 44 – Protected against the penetration of solid objects exceeding 1.0mm in diameter and against penetration of water jets that may affect the product operation.	First Digit : A 1.0mm diameter test wire should not penetrate in any apparent opening (force = 1 N $\pm$ 10%)  Second Digit : A spray nozzle is used to spread a water jet in all possible directions.
Impact Resistance UL 746-C	After the test the product should not show any evidence of : - Live electrical parts accessible to the test probe, as described in this test specification. - Any results, which may affect the mechanical performance of the product. - Any results, which may increase the probability of electrical shocks.	The impact should be generated by dropping a steel ball – with a diameter of 50.8 mm and a mass of 0.535 kg – from a specified height sufficient to produce an impact energy of 6.8 J (0.69 13 kg.m.)
UV Resistance  UL 746-C	The sample physical properties average value after an accelerated aging with UV	According to ASTM G26, Exposure Method 1, Xenon Arc Lamp Type B or



<b>Test / Standard</b>	<b>Requirements</b>	<b>Test Procedures</b>
	radiation – should not be lower than 70% of its initial value, without aging, that is, a variation of + 30% is allowed.	ASTM G 155, Exposure Cycle I, with continuous exposure to light and intermittent exposure to water jets, with programmed cycles of 120 minutes, consisting of a 102 minutes light-only exposure
		and a 18 minutes exposure to light and water jets.
Withstanding Voltage UL 746-C	Product should withstand the specified voltage	A 5 kV voltage should be applied to the samples after the 40 hours conditioning cycle at $23 \pm 2^{\circ}\text{C}$ and $50 \pm 5\%$ relative humidity plus 96 hours at $35 \pm 2^{\circ}\text{C}$ and $90 \pm 5\%$ relative humidity.
Flammability UL 94	After the UV radiation accelerated aging, the material should maintain the same original flammability level (HB).	The test can be applied to test samples molded with the same material used for the base and the cap of the box or taking a piece of these components.
Flexural Strength ASTM D790 UL 746-C	After UV radiation accelerated aging, the average value for this test should not be lower than 70% of the original value, that is, a maximum variation of 30% is allowed.	A group of test samples without aging should be tested and the average values calculated. Another group should be aged under UV radiation then it should be tested and the new average should be calculated and compared to the initial average value.
Tensile Strength ASTM D638	After aging with UV Radiation, the average value	One of the test bodies must be tested without being

<b>Test / Standard</b>	<b>Requirements</b>	<b>Test Procedures</b>
UL 746-C	should not be lower than 70% of the initial values, that is, a maximum variation of 30% is allowed.	submitted to accelerated aging and is computed over mean values. Another group is submitted to the radiation induced aging and then tested and the new mean value is computed and compared to the first computed mean value.

**ANNEXURE-A**

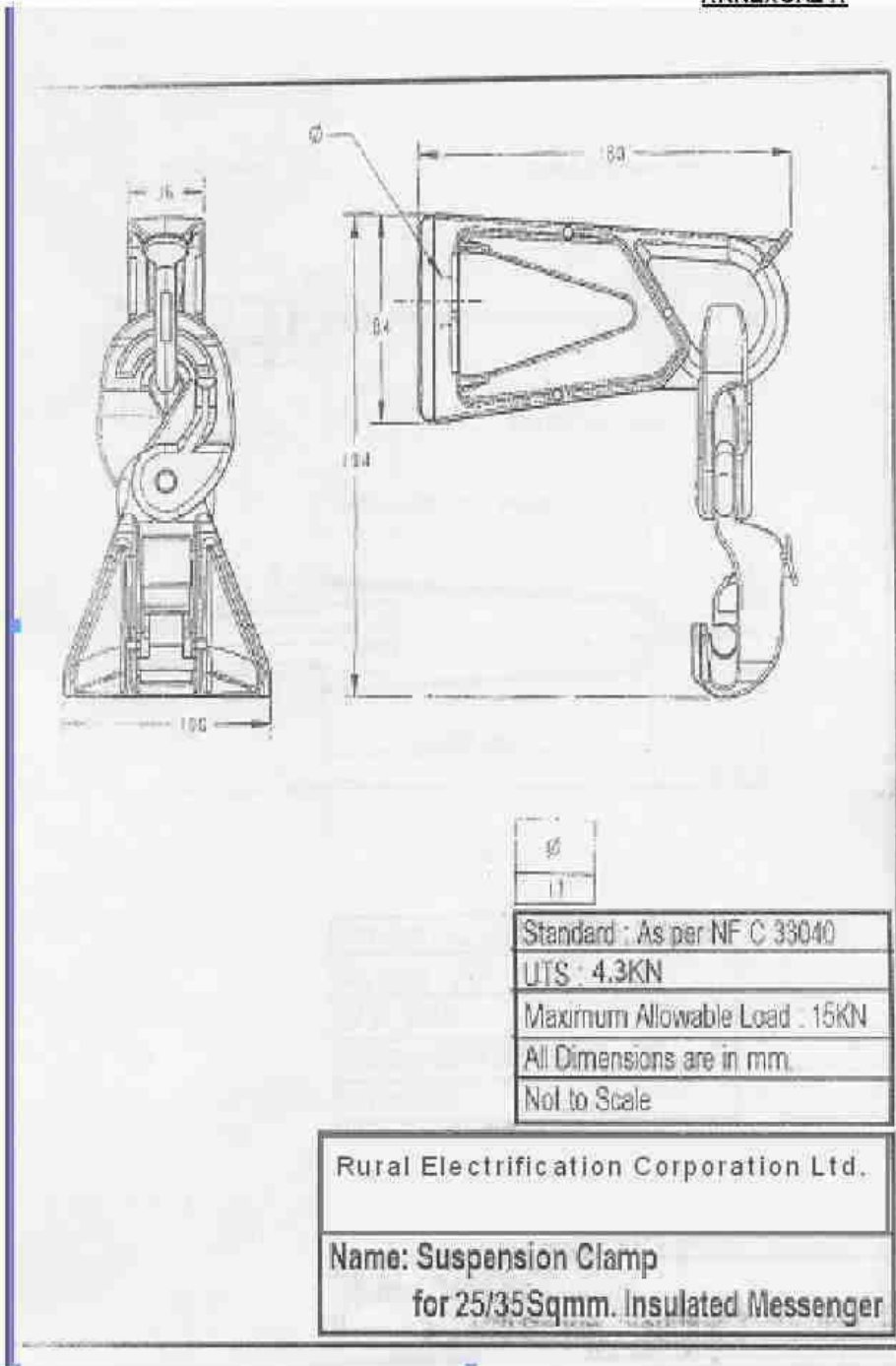

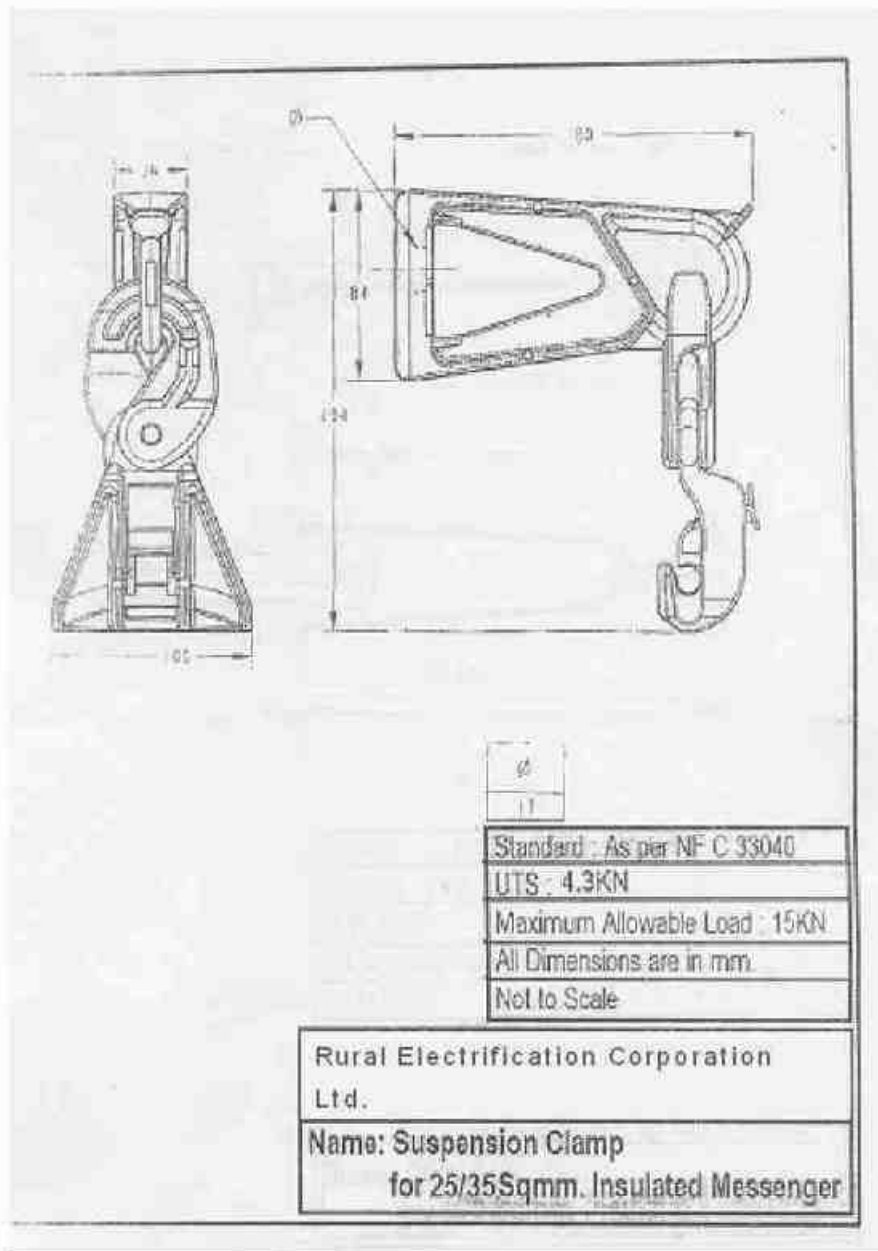
**ANNEXURE-B**

**ANNEXURE-C**

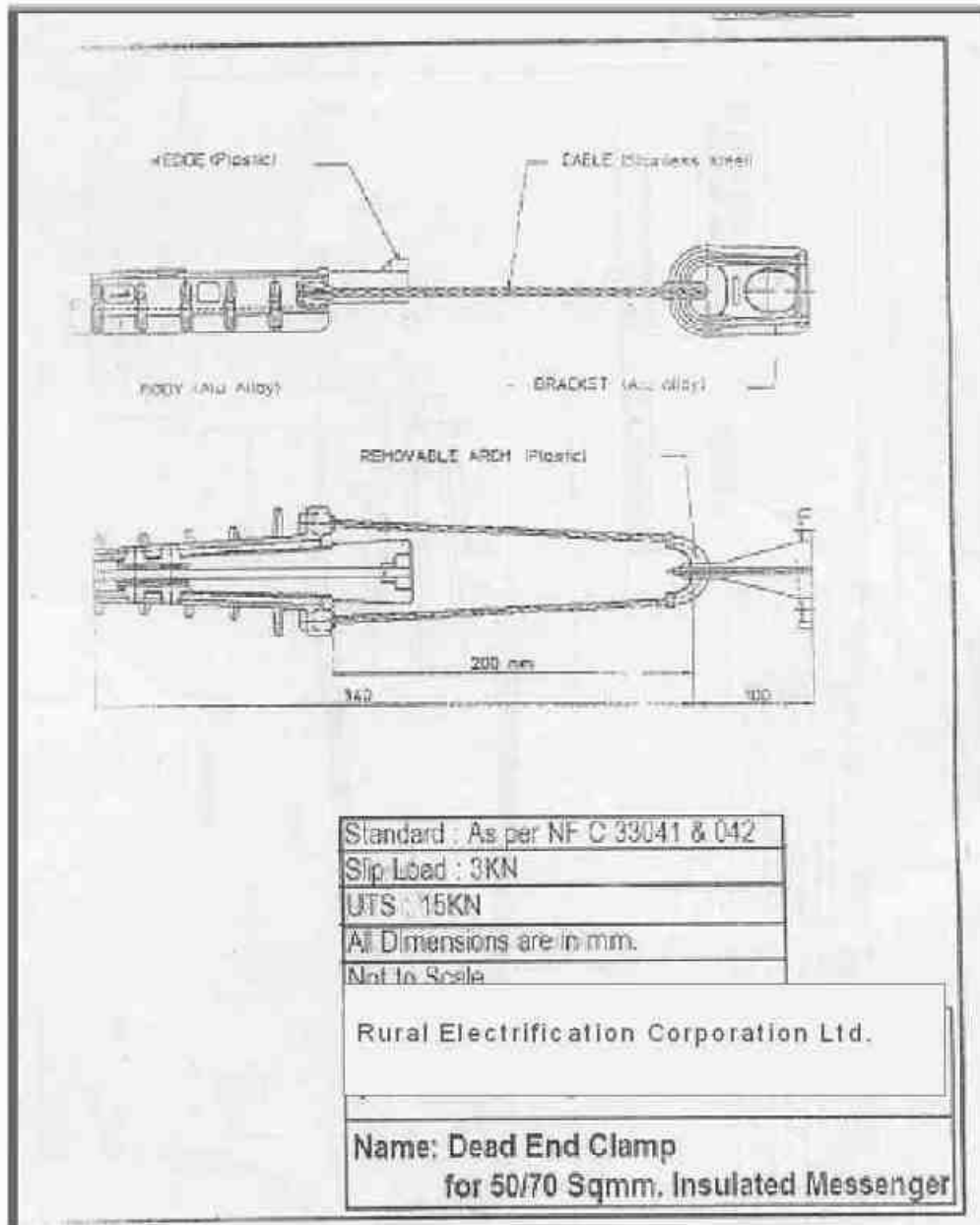

**ANNEXURE-D**

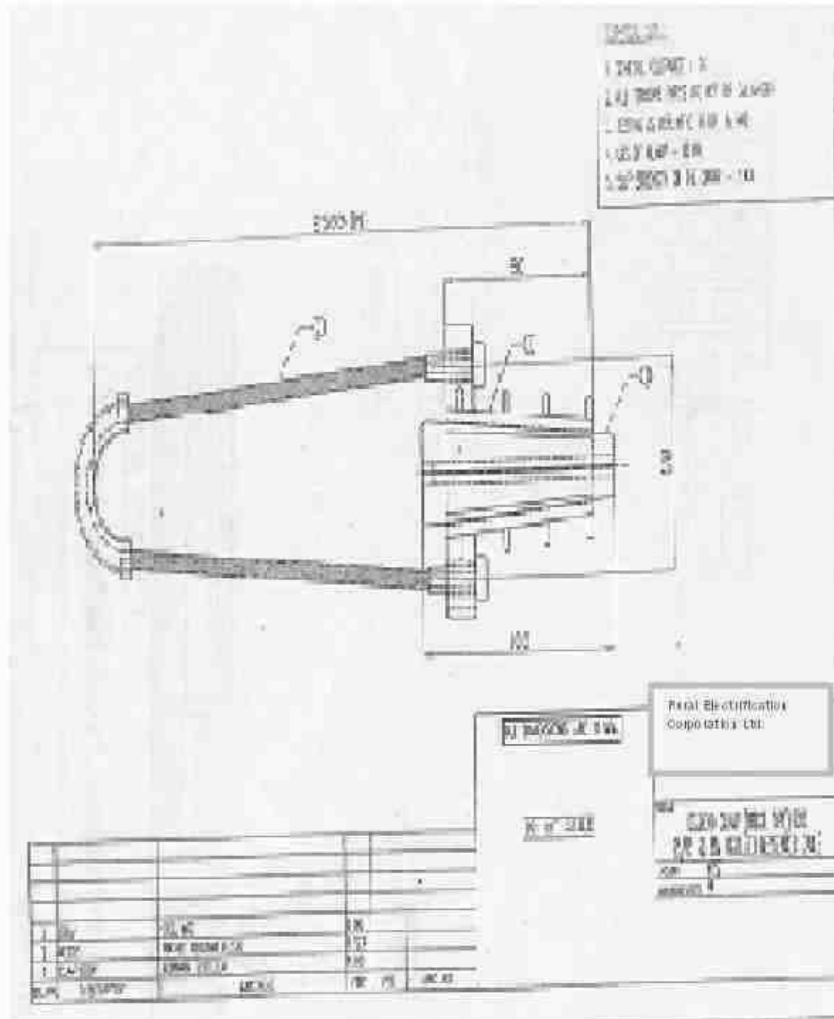

**ANNEXURE-E**

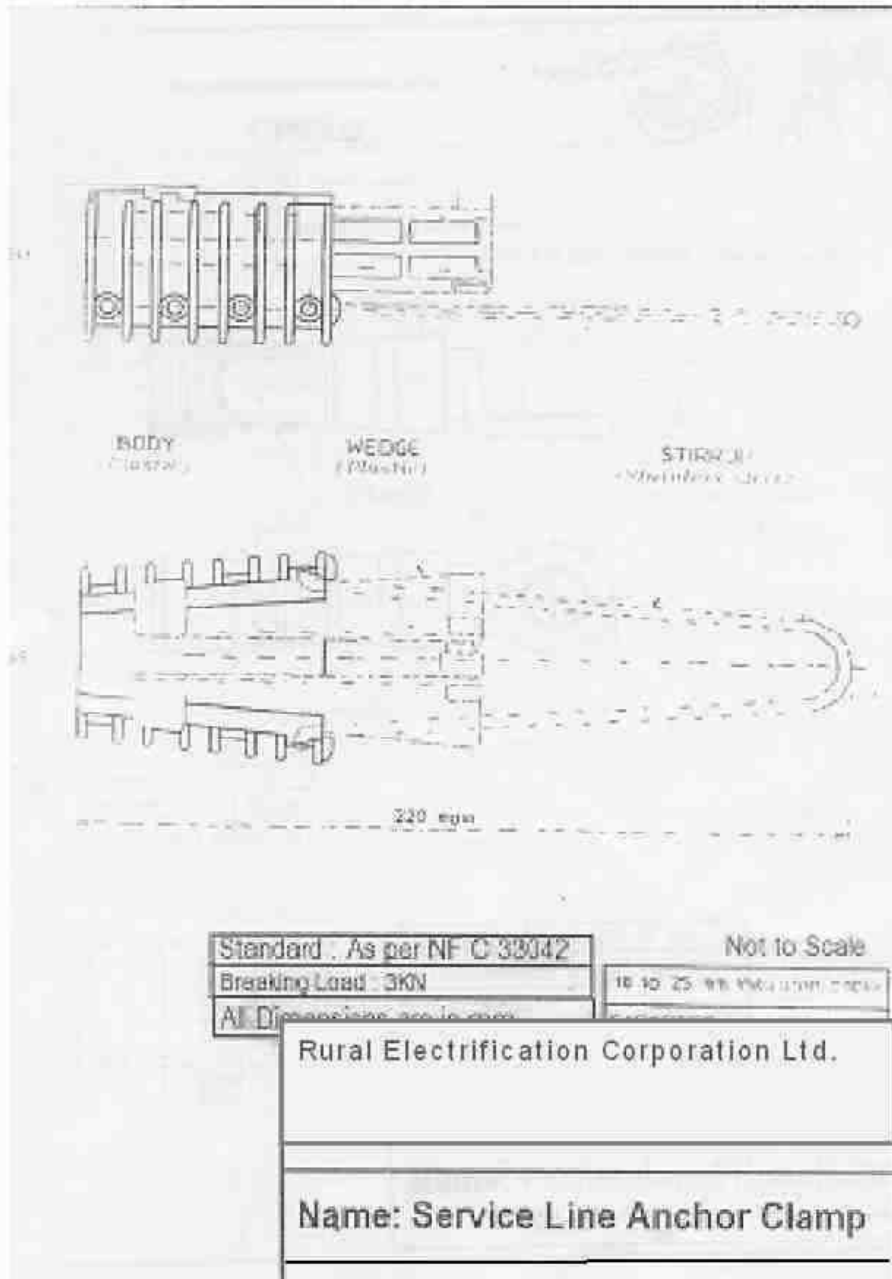

**ANNEXURE-F**

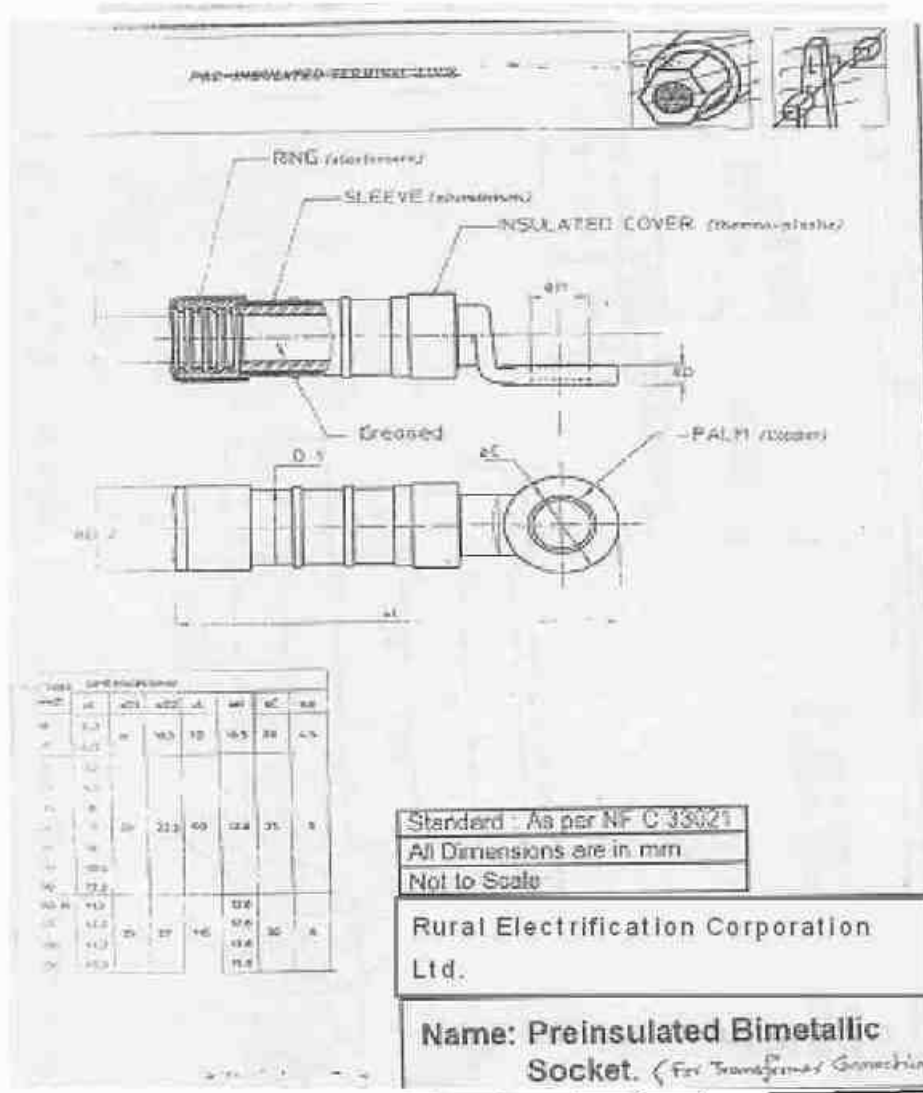



**ANNEXURE-G**

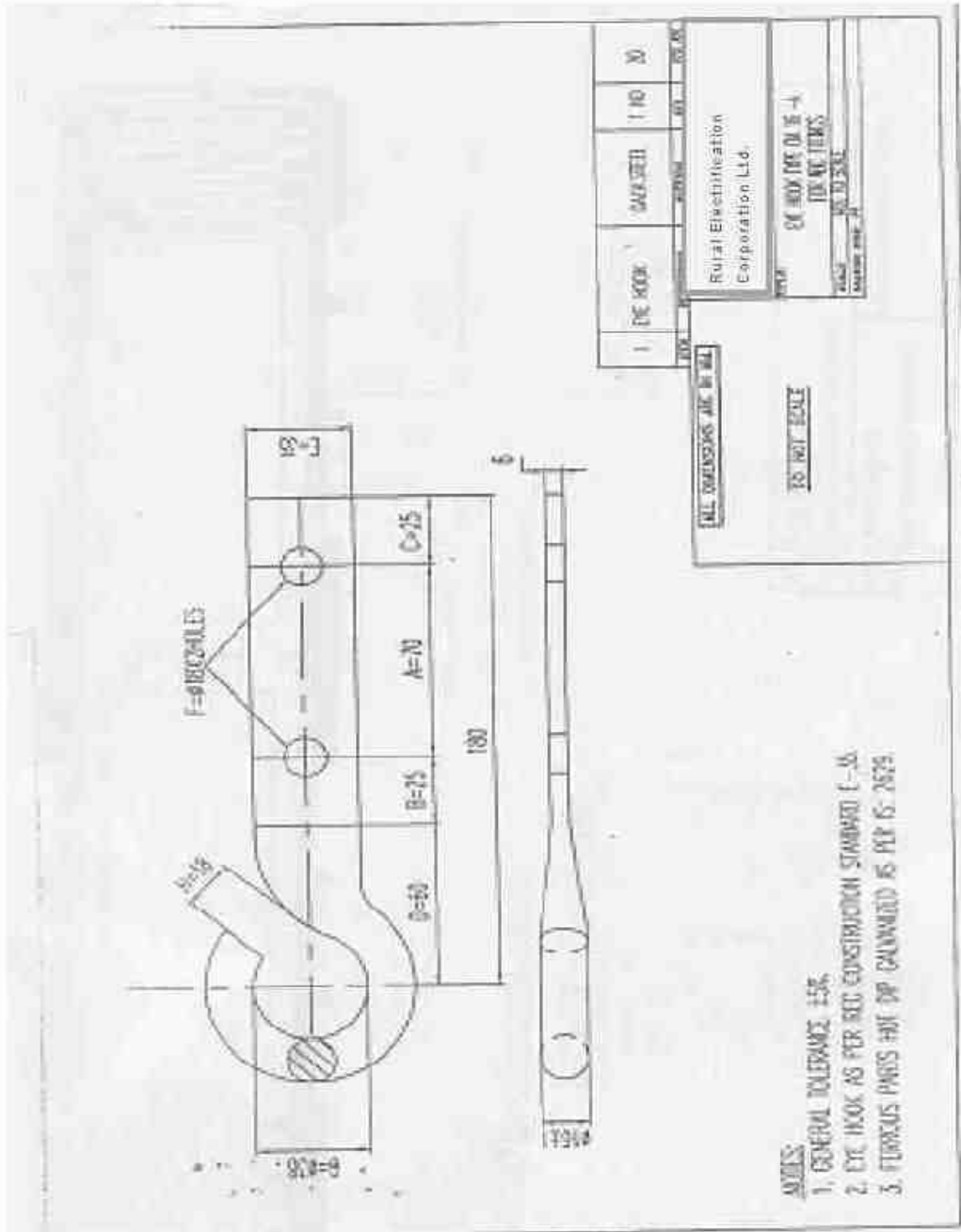

**ANNEXURE-H**

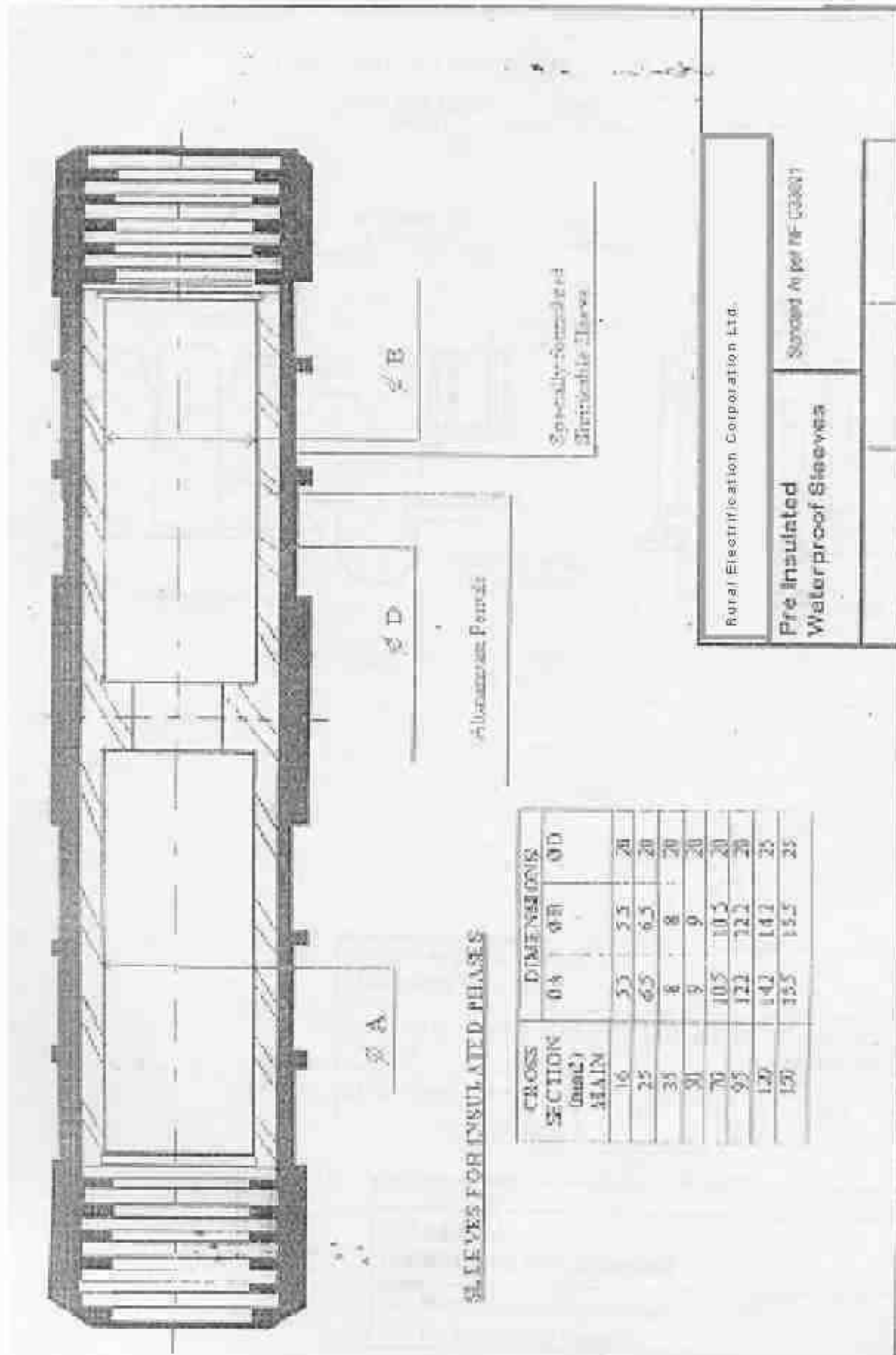

Rural Electrification Corporation Ltd.  
**Pre-Insulated Waterproof Sleeves**  
 Specified As per MR-030007

**ANNEXURE-I**

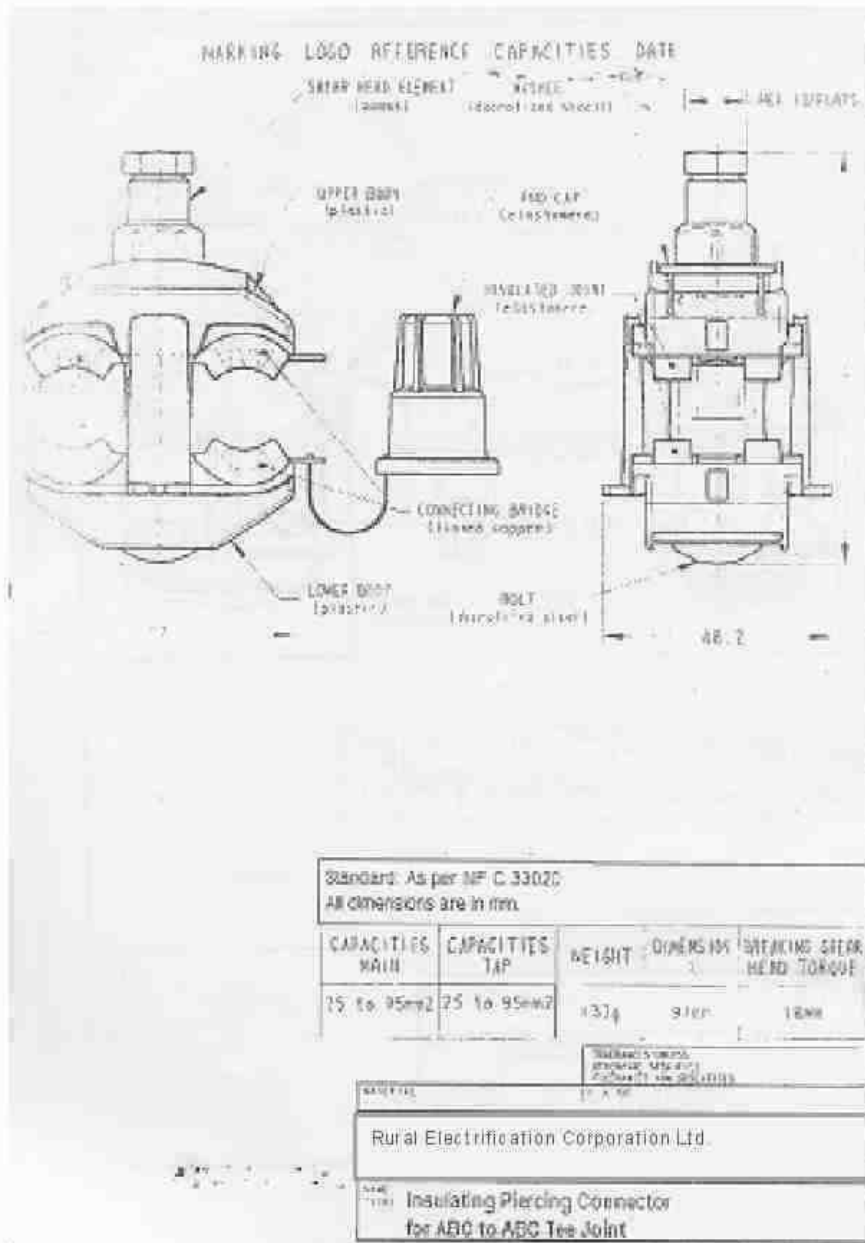

**ANNEXURE-J**

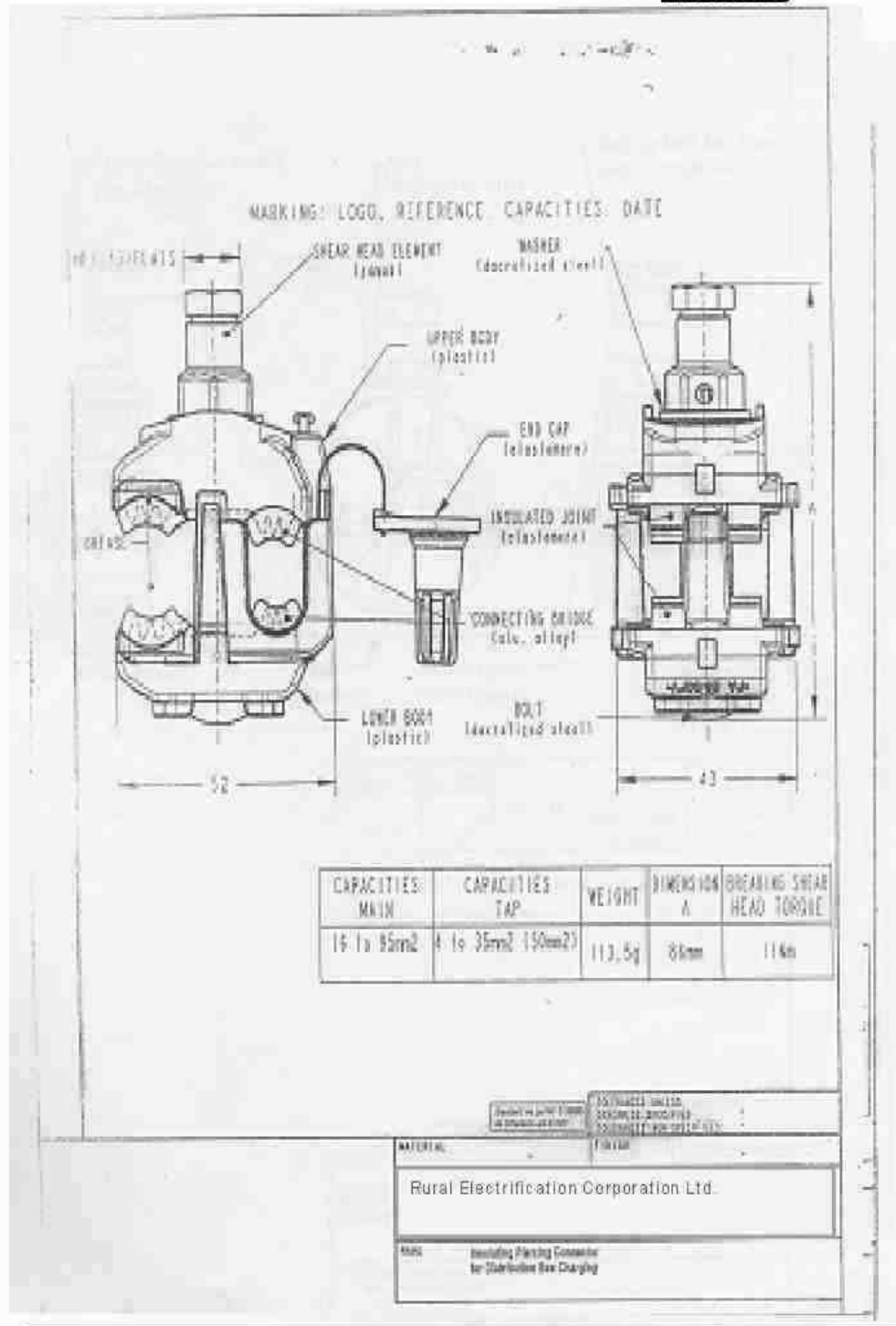

**ANNEXURE-K**

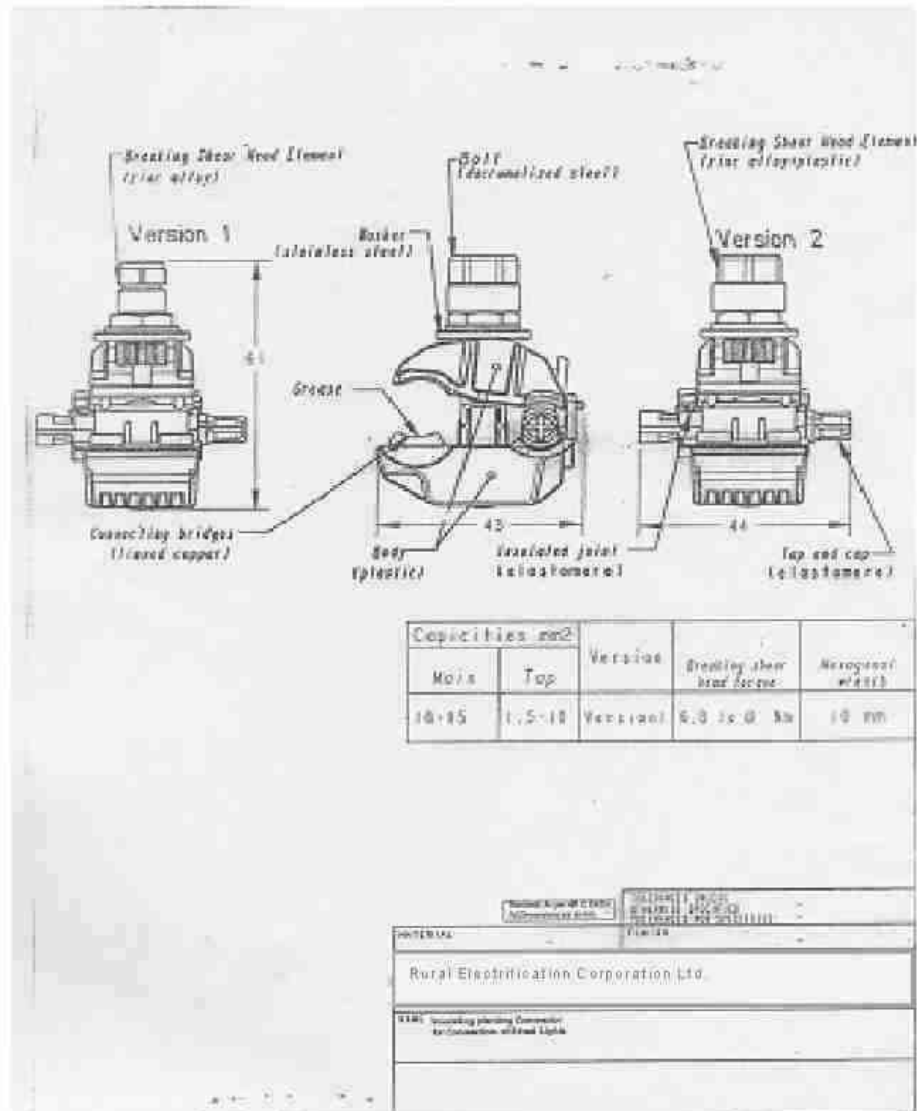

## 27. 11 kV and 33 kV Isolators

### 1) SCOPE

This specification provides for design, manufacture, testing at manufactures works, delivery of outdoor station type 11KV and 33KV (Local) manual operating mechanism isolating without/ with earthing blades and complete in all respect with bi-metallic connectors. Operating mechanism, fixing details etc. shall be as described herein.

### 2) PARTICULARS OF THE SYSTEM

The isolators to be provided under this specification are intended to be used on 3 phase A.C. 50 cycles, effectively grounded system. The nominal system voltages are 11 kV & 33 kV respectively.

### 3) STANDARD

The Isolator shall comply in all respects with IS: 9921 or IEC Publication No.: 129. Equipment meeting any other authoritative standard which ensures an equal or better quality than the standard mentioned above will also be accepted.

### 4) TYPE & RATING

Isolators shall have three posts per phase, triple pole single throw, gang operated out-door type silver plated contacts with horizontal operating blade and isolators posts arranged vertically. The isolators will be double break type. Rotating blade feature with pressure relieving contacts is necessary i.e. the isolator shall be described in detail along-with the offer. However, the design of turn & twist arrangement shall be subject to owner's approval. (Banging type feature is not acceptable). All isolators shall operate through 90 degree from their fully closed position to fully open position, so that the break is distinct and clearly visible from the ground level.

The equipment offered by the tenderer shall be designed for a normal current rating of 400 A for 11 KV & 630 A for 33 KV suitable for continuous service at the system voltage specified herein. The isolators are not required to operate under load but they must be called upon to handle magnetization currents of the power transformers and capacitive currents of bushings, bus-bars connections, very short lengths of cables and current of voltage transformers.

The rated insulation strength of the equipment shall not be lower than the levels specified in IS 9921 JEC publication No. 129, which are reproduced below

Standard voltage declared	Rated voltage of the Isolator	Standard withstand positive kV (peak)	Impulse Voltage polarity	One minute power frequency withstand voltage KV (RMS)

kv/rms					
		Across the isolating distance	To earth and between poles	Across the isolating distance	To earth and between poles
11 KV	12	85	75	45	35
33 KV	36	195	170	100	75

The 11 KV and 33 KV isolators are required with post insulators but with mounting structures. The isolators should be suitable for mounting on the Boards standard structures. The isolators shall be supplied with base channels along with fixing nuts, bolts and washers for mounting on the structured.

**5) TEMPRATURE RISE**

The maximum temperature attained by any part of the equipment when in service at site under continues full load conditions and exposed to the direct rays of Sun shall not exceed 45 degree centigrade above ambient temperature.

**6) ISOLATOR INSULATION**

Isolation to ground, insulation between open contacts and the insulation between phases of the completely assembled isolating switches shall be capable of withstanding the dielectric test voltage specified above.

**7) MAIN CONTACTS**

All isolators shall have heavy duty self aligning and high pressure line type fixed contacts of modern design and made of hard drawn electrolytic copper. The fixed contact should be of reverse loop type. The various parts shall be accordingly finished to ensure inter- changeability of similar components.

The fingers of fixed contacts shall be preferably in two pieces and each shall form the reverse loops to hold fixed contacts. The fixed contacts would be placed in 'c' clamp. The thickness of 'C' clamp shall be adequate. This channel shall be placed on a channel of adequate thickness. This channel shall be welded on an insulator mounting plate of 8mm thickness. The spring of fixed contact shall have housing to hold in place. This spring shall be made of stainless steel with adequate thickness. The pad for connection of terminal connector shall be of aluminum with thickness not less than 12 mm.

The switch blades forming the moving contacts shall be made from tubular section of hard drawn electrolytic copper having outer dia not less then 38 mm and thickness 3 mm. These contacts shall be liberally dimensioned so as to withstand safely the highest short circuit and over voltage that may be encountered during service. The surfaces of the contacts shall be rendered smooth and silver plated. The thickness of silver plating shall not be less than 15 microns for 11 KV and 25 microns for 33 KV. In nut shell, the male and female contact assemblies shall be of robust construction and design of these assemblies shall ensure the same.

1. Electro-dynamic withstands ability during short circuit without any risk of repulsion of contacts.
2. The current density in the copper parts shall not be less than 2 Amp/sq.mm and aluminium parts shall be less than 1 Amp/sq.mm.
3. Thermal withstand ability during short circuit.
4. Constant contact pressure even when the live parts of the insulator stacks are subjected to tensile stresses due to linear expansion of connected bus bar of flexible conductors either because of temperature verification or strong winds.
5. Wiping action during closing and opening.
6. Self alignment assuring closing of the switch without minute adjustment.

The earthing switch should be provided with three sets of suitable type of fixed contacts below the fixed contacts assemblies of the main switch on the incoming supply side and the sets of moving contacts having ganged operation. These contacts shall be fabricated out of electrolytic copper for 33 KV isolators with earth switch and designed to withstand current on the line.

Arcing contacts / Horn: Arcing contacts are not required.

Auxiliary switches : Auxiliary switches are not required.

#### **8) CONNECTORS**

The connectors for 11KV isolator shall be made of Aluminium alloy LM-9 or LM-25 and shall be suitable for Squirrel, Weasel and Rabbit ACSR Conductors for 11KV and Raccoon/Dog conductors for 33 KV with horizontal and vertical takeoff arrangement. The details in regard to dimensions, the number of bolts to be provided, material and manufacture shall be furnished by the bidder for owner approval before manufacturing. The groove provided in the connection should be able to accommodate conductor size mentioned above smoothly.

The clamps to be offered should be manufactured by gravity die-casting method only and not by sand casting process. It is necessary that suitable clamps are offered along with the isolator and also it is obligatory to give complete technical particular of clamps along with the drawing, as per details given above and also as per following detail.

1. The terminal connector shall be manufactured and tested as per IS: 5561.
2. All castings shall be free from blow holes, surface blisters, cracks and cavities.
3. All the sharp edges shall be blurred and rounded off.
4. No part of the clamp shall be less than 12 mm thick.
5. All current carrying parts shall be designed and manufactured to have minimum contact resistance.
6. Connectors shall be designed to be corona free in accordance with the requirement of IS: 5561.
7. All nuts and bolts shall be made of stainless steel only. Bimetallic sleeve/liner shall be 2 mm thick



Wherever necessary, bi-metallic strip of standard quality and adequate dimension shall be used.

## 9) POST INSULATOR

11KV / 33KV insulators shall be of reputed make subject to owner approval. The post insulators for the above **11 KV isolators shall comprise of three numbers 11 KV insulators per stack and 9 such stack shall be supplied with each isolator.\*** Similarly, **for 33 KV isolators, two numbers 33 KV insulators per stack and 9 stacks shall be supplied with each isolator\***. The insulator stack shall conform to the latest applicable Indian or IEC standard and in particulars to the IS; 2544 specification for porcelain post insulators. The porcelain used for manufactures of insulators shall be homogeneous, free from flaws or imperfections that might affect the mechanical or dielectric quality, and they shall be thoroughly vitrified, tough and impervious to moisture. The glazing of the porcelain shall be uniform brown colour, free from glisters, burns and other similar defects. Insulators of the same rating and type shall be interchangeable.

The porcelain and metal parts should be assembled in such a manner that any thermal expansion differential between the metal and the porcelain parts throughout the range of temperature variation shall not loosen the parts or create undue internal stresses which may affect the electrical or mechanical strength and rigidity. Each cap and base shall be of high-grade cast steel or malleable steel casting and they shall be machine faced and smoothly galvanised. The cap and base of the insulators shall be interchangeable with each other.

The tenders shall in variably enclose with the offer, the type test certificate and other relevant technical guaranteed particulars of insulators offered by them. Please note that isolators without type test certificates will not be accepted.

Each 11KV / 33KV Post Insulators used in the isolators should have technical particulars as detailed below:-

**\* Amendment issued vide letter No. REC/DDUGJY/SBD/TS/2017-18D. No.3091 Dated 25.08.2017.**

	<b>11KV</b>	<b>33KV</b>
1. Nominal system voltage KV (rms)	11	33
2. Highest system voltage KV (rms)	12	36
3. Dry P.F. One minute with stand KV (rms)	35	75
4. Wet PF one minute withstand KV (rms)	35	75
5. P.F. Puncture withstand test voltage KV	1.3 time the actual dry flash over voltage of the unit	
6. Impulse voltage withstand test KV (peak)	75	170
7. Visible discharge test KV voltage	9	27
8. Creepage distance mm (min)	320	580
9. Tensile strength in KN	10KN	16KN
10. Short time current rating for 3 Secs	25KA	25KA

For 33 KV Isolators: In place of 33 KV Post Insulator the composition of 2 units of 22KV Post Insulators per stack complying the following parameters are acceptable:-

(a) Norminal system voltage	:	33 KV
(b) Highest system voltage	:	36 KV
(c) Impulse voltage withstand	:	170 KV
(d) Power frequency wet withstand voltage	:	75 KV
(e) Height of stack	:	500 mm
(f) Creepage distance (Minimum)	:	840 mm
(g) Tensile Strength	:	30KN
(h) Bending strength	:	4.5KN

#### **Operating Mechanism for 11KV / 33KV Isolators:-**

All Isolators and earthing switches shall have separate dependent manual operation. The Isolator should be provided with padlocking arrangements for locking in both end position to avoid unintentional operation. For this purpose Godrej make 5 lever brass padlocks having high neck with three keys shall be provided. The isolating distances should be visible for isolators.

The Isolators and Isolators with earth switch inclusive of their operating mechanism should be such that they cannot come out of their open or close position by gravity wind pressure, vibrations reasonable shocks or accidental touching of connecting rods of the operating mechanism. Isolators should be capable of resisting in closed position, the dynamic and thermal effects of maximum possible short circuit current at the installation point. They shall be so constructed that they do not open under the influence of the short circuit current. The operating mechanism should be of robust construction and easy to operate by a single person and conveniently located for local operation in the switchyard. Provision for earthing of operating handle by means of 8 SWG GS wire must be made.

#### **10) PIPES**

Tandem pipes operating handle shall be class B ISI marked type having atleast 24mm internal diameter for 11KV/33KV isolator. The operating pipe shall also be class B ISI marked with internal diameter of atleast 32 mm and 38 mm for 11 KV and 33KV isolators respectively.

The pipe shall be terminated in to suitable universal type joints between the insulator bottom bearing and operating mechanism.

#### **11) BASE CHANNEL**

The Isolator shall be mounted on base fabricated from steel channel section of adequate size not less than 75x40x6 mm for 11KV and 100x50x6 mm for 33KV.

To withstand total weight of isolator and insulator and also all the forces that may encounter by the isolator during services, suitable holes shall be provided on this base channel to facilitates it's mounting on our standard structures. The steel channel in each phase shall be mounted in vertical position and over it two mounting plates atleast 8mm thick with suitable nuts and bolts shall be provided for minor adjustment at site.

**12) CLEARANCES**

We have adopted the following minimum clearance for isolators in our system .The bidder should therefore keep the same in view while submitting their offers: -

Description	Center distance between Poles (Center to Center) i.e. Phase to Phase clearance	Distance between center lines of outer posts on same pole
11 KV Isolator	75 Cm	60 Cm
33 KV Isolator	120 Cm	96 Cm

## 28. 11 kV and 33 kV Air Break Switches

### 1) SCOPE

This specification provides for manufacture, testing at works and supply of 11KV & 33KV AB switches. The 11KV and 33 KV AB switches shall conform to IS: 9920 (Part-I to IV)

### 2) AB SWITCHES

The 11KV & 33KV Air Break Switches are required with two poles in each phase. The AB Switches shall be supplied complete with phase coupling shaft, operating rod and operating handle. It shall be manually gang operated and vertically break and horizontal mounting type.

**The equipment offered by the bidder shall be designed for a normal current rating of 200 Amps and for continuous service at the system voltage specified as under:**

i) 11 KV AB Switch : 11KV + 10% continuous 50 C/s solidly grounded earthed neutral system

ii) 33KV AB Switch : 33 kV + 10% -do-

The length of break in the air shall not be less than 400 mm for 11KV AB Switches and 500 mm for 33 KV AB Switches.

The 11KV & 33KV AB Switches are required with post insulators. The AB switches should be suitable for mounting on the structure. The mounting structure will be arranged by the bidder. However, the AB Switches shall be supplied with base channel for mounting on the structure which will be provided by the owner. The phase to phase spacing shall be 750mm in case of 11KV AB Switches & 1200mm in case of 33KV AB Switches.

### 3) POST INSULATORS

The complete set of three phase AB Switches shall have stacks of post insulators.

11KV AB Switches : 3 No. 11KV Post Insulator per stack\* (1 No. 11kV post insulator per stack shall be permitted)

33KV AB Switches : 3 No. 33KV Post Insulator per stack\* (2 No. 22kV or 3 No. 11kV post insulator shall be permitted in each stack).

The post insulators should conform to the latest applicable Indian standards IS: 2544 Specification for Porcelain Post insulator of compact solid core or long rod insulators are also acceptable. Creepage distance should be adequate for highly polluted outdoor atmosphere in open atmosphere. The porcelain used for manufacture of AB Switches should be homogeneous free from flaws or imperfections that might affect the mechanical dielectric quality. They shall be thoroughly vitrified, tough and impervious to moisture. The glazing of the porcelain

shall be of uniform brown in colour, free from blisters, burns and other similar defects. Insulators of the same rating and type shall be interchangeable.

\* Amendment issued vide letter No. REC/DDUGJY/SBD/TS/2017-18D. No.3091 Dated 25.08.2017.

The porcelain and metal parts shall be assembled in such a manner that any thermal expansion differential between the metal and porcelain parts through the range of temperature variation shall not loose the parts or create undue internal stresses which may affect the electrical or mechanical strength. Cap and base of the insulators shall be interchangeable with each other. The cap and base shall be properly cemented with insulators to give perfect grip. Excess cementing must be avoided.

Each 11KV & 33KV Post Insulators should have technical particulars as detailed below:

		11 kV	33 kV
i	Nominal system voltage kV (rms)	11	33
ii	Highest system voltage kV (rms.)	12	36
iii	Dry Power Frequency one kV minute withstand voltage (rms) in KV	35	75
iv	Wet Power frequency one minute withstand voltage (rms) in KV	35	75
v	Power Frequency puncture kV (rms) voltage	1.3 times the actual dry flashover voltage	
vi	Impulse withstand voltage kV (Peak)	75	170
vi	Visible discharge voltage kV (rms)	9	27
vi	Creepage distance in mm (minimum)	320	580

The rated insulation level of the AB Switches shall not be lower than the values specified below:-

Sl. No	Standard declared voltage KV/R MS	Rated Voltage of the AB Switches	Standard impulse withstand voltage (positive & negative polarity kV (Peak)	One Minute power frequency withstand voltage kV (rms)

			Across the Isolating distance	To earth & between poles	Across the Isolating distance	To earth & between poles
i	11KV	12KV	85KV	75KV	32KV	28KV
ii	33KV	36KV	195KV	170KV	80KV	70KV

#### 4) TEMPERATURE RISE

~~The maximum temperature attained by any part of the equipment when in service at site under continuous full load conditions and exposed to the direct rays of Sun shall not exceed 45 degree above ambient.~~ **Maximum permitted temperature rise over ambient temperature will be as per Table-4 of IS 9921 (Part-2). \***

**Amendment issued vide letter No. REC/DDUGJY/SBD/TS/2017-18D. No.3091 Dated 25.08.2017.**

#### 5) MAIN CONTACTS

AB Switches shall have heavy duty self-aligning type contacts made of hard drawn electrolytic copper/brass. The various parts should be accordingly finished to ensure interchangeability of similar components. The moving contacts of the switch shall be made from hard drawn electrolytic copper brass. This contact shall have dimensions as per drawing attached so as to withstand safely the highest short-circuit currents and over voltage that may be encountered during service. The surface of the contact shall be rounded smooth and silver-plated. In nut shell the male and female contact assemblies shall ensure.

1. Electro-dynamic withstands ability during short circuits without any risk of repulsion of contacts.
2. Thermal withstands ability during short circuits.
3. Constant contact pressure even when the lower parts of the insulator stacks are subjected to tensile stresses due to linear expansion of connected bus bar of flexible conductors either because of temperature variations or strong winds.
4. Wiping action during closing and opening.
5. Fault alignment assuring closing of the switch without minute adjustments.

#### 6) CONNECTORS

The connectors shall be made of hard drawn electrolytic copper or brass suitable for Raccoon/Dog ACSR conductor for both 11KV & 33KV AB Switches. The connector should be 4 -bolt type.

#### 7) OPERATING MECHANISM

All AB Switches shall have separate independent manual operation. They should be provided with ON/OFF indicators and padlocking arrangements for locking in both the end positions to avoid unintentional operation. The isolating distances should also be visible for the AB Switches.

The AB Switch will be supplied with following accessories:

Sl	Item	Size of 11KV AB Switch	Size of 33KV AB Switch
i	Operating Rod (GI dia) ISI mark	Length 5.50 meter dia: 25MM	Length 5.50 mtrs dia: 40MM
ii	Phase coupling square rod (GI) ISI mark	Length 1800 mm Size 25x25 mm	Length 2700 mm Size 40 x 40 mm
iii	Hot dip galvanized Operating handle (GI)	1 No.	1 No.

The AB Switches shall be capable to resist any chance of opening out when in closed position. The operating Mechanism should be of robust constructions, easy to operate by single person and to be located conveniently for local operation in the switchyard. The GI pipe shall conform to ('B' class or Medium class Blue strip) ISS: 1239-68 and ISI marked by embossing. The vertical down rod should be provided with adequate joint in the mid section to avoid bending or buckling. Additional leverage should be provided to maintain mechanical force with minimum efforts.

All iron parts should be hot dip galvanized as per IS 4759-1979 and zinc coating shall not be less than 610 gm/sq. meter. All brass parts should be silver plated and all nuts and bolts should be hot dip galvanized.

#### 8) **ARCING HORNS**

It shall be simple and replaceable type. They should be capable of interrupting line-charging current. They shall be of first make and after break type.

#### 9) **BUSH**

The design and construction of bush shall embody all the features required to withstand climatic conditions specified so as to ensure dependable and effective operations specified even after long periods of inaction of these Air Break Switches. They shall be made from highly polished Bronze metal with adequate provision for periodic lubrication through nipples and vent.

#### 10) **DESIGN, MATERIALS AND WORKMANSHIP**

All materials used in the construction of the equipment shall be of the appropriate class, well finished and of approved design and material. All similar parts should be accurately finished and interchangeable.

Special attention shall be paid to tropical treatment to all the equipment, as it will be subjected during service to extremely severe exposure to atmospheric moisture and to long period of high ambient temperature. All current carrying parts shall be of non-ferrous metal or alloys and shall be designed to limit sharp points/edges and similar sharp faces.

The firm should have the following type test certificate. The type test should be from CPRI or equivalent lab:-

1. Test to prove capability of rated peak short circuit current and the rated short time current. The rated short time current should correspond to minimum of 10K Amp and the peak short circuit current should correspond to minimum of 25K Amps.
2. Lightning impulse voltage test with positive & negative polarity.
3. Power Frequency voltage dry test and wet test
4. Temperature rise test
5. Mill volt drop tests

The above tests should be performed on the AB Switches, manufactured as per owner approved drawing with the specification. Along with the type test certificate, the certified copy of the drawing (from the testing lab) should also be kept for inspection of our officer. Also the test certificates should not be older than 5 years from the date of opening of tender.

Dimension of 11 & 33KV AB Switches in (Max.)Tolerance 5%.

Sl.	Particulars	11KV AB Switch	33KV AB Switch
i	MS Channel	450x75x40	675x100x50
ii	Creepage distance of Post Insulator	320mm (Min)	580mm (Min)
iii	Highest of Port shell	254 mm	368 mm
iv	Fixed contact assembly		
	i) Base	165x36x8	165x36x8
	ii) Contact	70x30x6	70x30x6
	iii) GI cover	110x44	140x44
	v) Spring	6 Nos.	6 Nos.

#### 11) Moving Contact Assembly

i	Base Assembly	135x25x8	170x40x8
---	---------------	----------	----------



ii	Moving	180x25x9	290x25x14
iii	Bush	Bronze Metal	Bronze Metal
iv	Thickness of Grooves	7	11

## 12) Connectors

i	Connector	60x50x8 (Moving & fix both)	60x50x8 (Moving & fix both)
---	-----------	-----------------------------	-----------------------------

The bidder should provide AB Switches with terminal connectors, set of insulators, mechanical inter works and arcing horns sets. The base channel for the mounting of AB Switches shall also be included in the scope of AB Switches. The operating mechanisms together with down pipe operating handle etc. are also included in the scope of supply.

## **29. 11 kV Drop Out Fuse Cut Outs**

### **1. SCOPE**

This specification covers outdoor, open, drop-out expulsion type Fuse Cutouts suitable for installation in 50 Hz, 11 KV distribution system.

### **2. APPLICATION**

The distribution fuse cutouts are intended for use in distribution transformers and have no inherent load break capacity.

### **3. APPLICABLE STANDARD**

Unless otherwise modified in this specification, the cutout shall conform to IS:9385 (Part-I to III) as amended from time to time.

### **4. RATED VOLTAGE**

The rated voltage shall be 12 KV.

### **5. RATED CURRENT**

The rated current shall be 100 A.

### **6. RATED LIGHTNING IMPULSE WITHSTAND VOLTAGE VALUES FOR THE FUSE BASE**

The rated lightning impulse withstand voltages both for positive and negative polarities shall be as given below:

- |   |              |
|---|--------------|
| a) To earth and between poles                 | 75 KV (Peak) |
| b) Across the isolating distance of fuse base | 85 KV (Peak) |

### **7. RATED ONE MINUTE POWER FREQUENCY WITHSTAND VOLTAGE (DRY & WET) VALUES FOR THE FUSE BASE**

- |                                  |             |
|----------------------------------|-------------|
| a) To earth and between poles    | 28 KV (rms) |
| b) Across the isolating distance | 32 KV (rms) |

### **8. TEMPERATURE RISE LIMIT (In Air)**

- |  |      |
|--|------|
| a) Copper contacts silver faced  | 65°C |
| b) Terminals   | 50°C |
| c) Metal parts acting as springs. - The temp. shall not reach such a value that elasticity of metal is changed |      |

## **9. RATED BREAKING CAPACITY**

The rated breaking capacity shall be 8 KA (Asymmetrical).

## **10. GENERAL REQUIREMENTS/CONSTRUCTIONAL DETAILS**

**10.1** The cutouts shall be of single vent type (downward) having a front connected fuse carrier suitable for angle mounting.

**10.2** All ferrous parts shall be hot dip galvanised in accordance with the latest version of IS:2633. Nuts and bolts shall conform to IS:1364. Spring washers shall be electro-galvanised.

**10.3** Typical constructional details of the fuse cutout are shown in Fig. 1

## **11. FUSE BASE TOP ASSEMBLY**

**11.1** The top current carrying parts shall be made of a highly conductive copper alloy and the contact portion shall be silver plated for corrosion resistance and efficient current flow. The contact shall have a socket cavity for latching and holding firmly the fuse carrier until the fault interruption is completed within the fuse.

**11.2** The top contact shall be actuated by a strong steel spring which keeps it under sufficient pressure to maintain a firm contact with the fuse carrier during all operating conditions. The spring shall also provide flexibility and absorbs most of the stresses when the fuse carrier is pushed into the closing position.

**11.3** The current carrying parts of the assembly shall be protected from water and dust formation by a stainless steel top cover.

**11.4** The top contact assembly shall have a robust galvanised steel hook to align and guide the fuse carrier into the socket latch even when the fuse carrier is closed at an off-centre angle.

**11.5** The top assembly shall have an aluminum alloy terminal connector (refer clause 19).

**11.6** The top assembly shall be robust enough to absorb bulk of the forces during the fuse carrier closing and opening operations and shall not over-stress the spring contact. It shall also prohibit accidental opening of the fuse carrier due to vibrations or impact.

## **12. FUSE BASE BOTTOM ASSEMBLY**

**12.1** The conducting parts shall be made of high strength highly conductive copper alloy and the contact portion shall be silver plated for corrosion resistance and

shall provide a low resistance current path from the bottom fuse carrier contacts to the bottom terminal connector.

**12.2** The bottom assembly shall have hinge contacts made from highly conductive, anti-corrosive copper alloy and shall accommodate and make a firm contact with the fuse carrier bottom assembly. The fuse carrier shall be placed easily in or lifted from The hinges without any maneuvering. In addition, the bottom assembly shall perform the following functions :-

- i) When opened manually or after fault interruption the fuse carrier shall swing through 180° to the vertical and its further travel shall be prevented by the fuse base bottom assembly.
- ii) The fuse carrier shall be prevented from slipping out of the self locking hinges during all operating conditions and only when the fuse carrier has reached its fully open position can it be removed from the hinge support.

**12.3** The assembly shall have an aluminium alloy terminal connector (refer clause 19).

### **13. FUSE CARRIER TOP ASSEMBLY**

**13.1** The fuse carrier top contact shall have a solid replaceable cap made from highly conductive, anti-corrosive copper alloy and the contact portion shall be silver plated to provide a low resistance current path from the Fuse Base Top Contact to the Fuse Link. It shall make a firm contact with the button head of the fuse link and shall provide a protective enclosure to the fuse link to check spreading of arc during fault interruptions.

**13.2** The fuse carrier shall be provided with a cast bronze opening eye (pull ring) suitable for operation with a hook stick from the ground level to pull-out or close-in the fuse carrier by manual operation.

### **14. FUSE CARRIER BOTTOM ASSEMBLY**

**14.1** The fuse carrier bottom assembly shall be made of bronze castings with silver plating at the contact points to efficiently transfer current to fuse base. It shall make smooth contact with the fuse base bottom assembly during closing operation.

**14.2** The bottom assembly shall have a lifting eye for the hook stick for removing or replacing the fuse carrier.

**14.3** The bottom assembly shall have a suitable ejector which shall perform the following functions :

- i) It shall keep the fuse link in the centre of fuse tube and keep it tensioned under all operating conditions.

ii) It shall be capable of absorbing the shock when the fuse carrier is pushed into the closed position and shall not allow the fuse link to be damaged. This is specially important when the fuse link is of low-ampere rating.

iii) The ejector at the instant of interruption shall retain the fuse carrier in the closed position long enough to ensure that the arc is extinguished within the fuse tube thereby excluding the possibility of arcing and subsequent damage at the contact surfaces.

iv) The ejector shall help the fuse link separation after fault interruption, allowing the fuse carrier to drop out and clearing the pigtail of the blown fuse link through the bore of fuse tube.

#### **15. FUSE BASE (PORCELAIN)**

The fuse base shall be a bird-proof, single unit porcelain insulator with a creepage distance (to earth) not less than 320mm. The top and bottom assemblies as also the middle clamping hardwares shall be either embedded in the porcelain insulator with sulphur cement or suitably clamped in position. For embedded components, the pull out strength should be such as to result in breaking of the porcelain before pull out occurs in a test. For porcelain insulators, the beam strength shall not be less than 1000 Kg.

#### **16. FUSE TUBE**

The fuse tube shall be made of fibre glass coated with ultraviolet inhibitor on the outer surface and having arc quenching bone fibre liner inside. The tube shall have high bursting strength to sustain high pressure of the gases during fault interruption. The inside diameter of the fuse tube shall be 17.5mm. The

solid cap of the fuse carrier shall clamp the button head of the fuse link, closing the top end of the fuse tube and allowing only the downward venting during fault interruption.

#### **17. TYPE TESTS**

The cutout shall be subjected to the following type tests :

i) Dielectric tests (rated impulse withstands and rated one minute power frequency with stand test voltages)

ii) Temperature rise test

The above tests shall be carried out in accordance with IS:9385 Part I & II.

**For Porcelain Fuse Base only.**

- iii) Pull out test for embedded components of the fuse base
- iv) Beam strength of porcelain base

## **18. MOUNTING ARRANGEMENT**

- 18.1** The cutouts shall be provided with a suitable arrangement for mounting these on 75x40mm or 100x50mm channel cross arm in such a way that the centre line of the fuse base is at an angle of 15° to 20° from the vertical and shall provide the necessary clearances from the support. Mounting arrangement shall be made of high strength galvanised steel flat and shall be robust enough to sustain the various stresses encountered during all operating conditions of the cutout. For more details see enclosed figure 2.
- 18.2** Strength of the component marked 1 (see figure) shall be determined by clamping the member with the shorter leg at the top to a rigid support by M-10 carriage bolts. A downward force shall be applied along the axis of M-14 carriage bolt parallel to the longer leg and in the direction of longer leg of the member under test. A load of 50 Kg. shall be applied and then removed to take up any slack in the mounting arrangement before the measurement of position is taken, the permanent set measured at the axis of the M-14 carriage bolt shall not exceed 1.6mm when a load of 425 Kg. is applied and removed.
- 18.3** The strength of the M-14 bolt shall in no case be less than 1900 Kg. and the strength of M-10 bolts not less than 3500 Kg.

## **19. TERMINAL CONNECTIONS**

The cut-out shall be provided with two aluminium alloy (alloy designation 2280 (A-11) as per IS:617-1975) terminal connectors at top and bottom of fuse base assemblies to receive aluminium conductors of diameters between 6.3mm to 10.05mm. These terminals shall be easily accessible irrespective of the cut-out location with respect to the pole. The terminals shall meet the test requirements of REC Construction Standard.

## **20. INSPECTION**

All tests and inspection shall be made at the place of manufacture unless otherwise especially agreed upon by the manufacturer and the purchaser at the time to purchase. The manufacturer shall afford the inspector representing the purchaser all reasonable facilities without charge, to satisfy him that the material is being furnished in accordance with this specification.

The purchaser has the right to have the tests carried out at his own cost by an independent agency whenever there is dispute regarding the quality of supply.

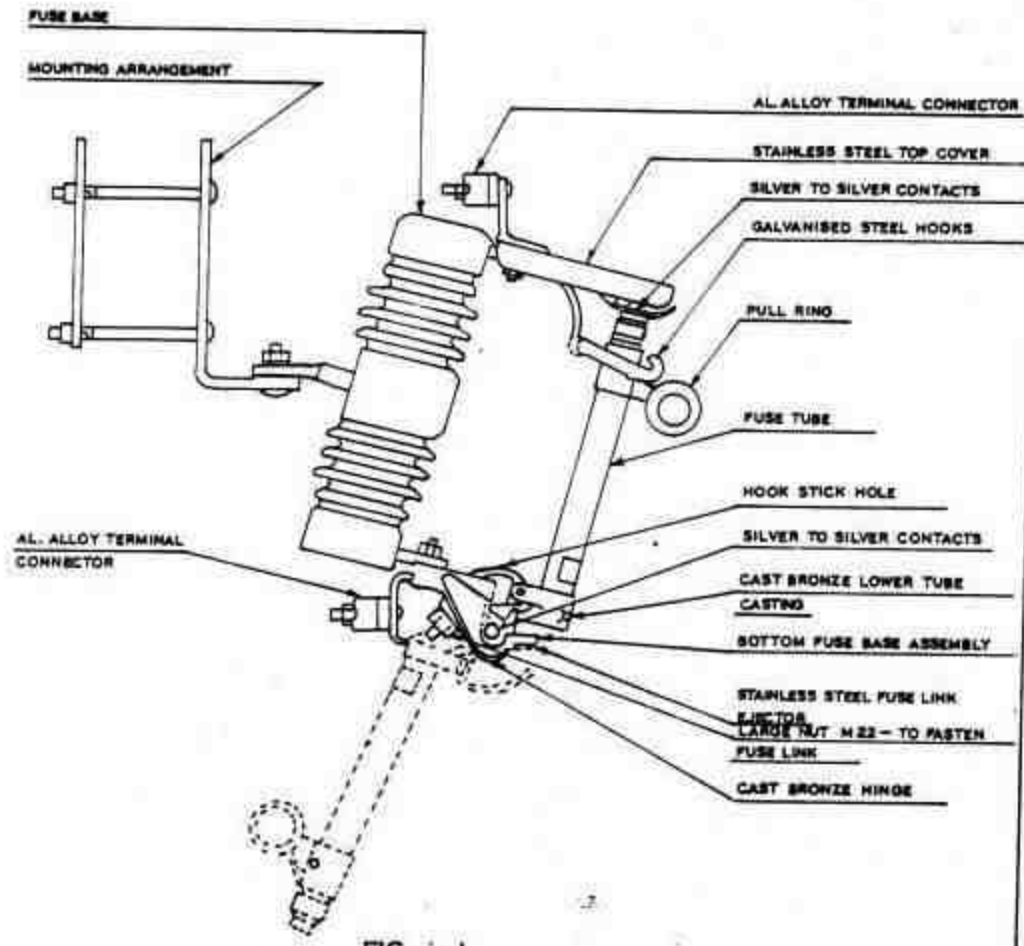

११ के. वी. फ्यूज कट-आउट का प्रारूपिक निर्माण विवरण  
 TYPICAL CONSTRUCTIONAL DETAILS OF 11KV  
 FUSE CUT-OUT

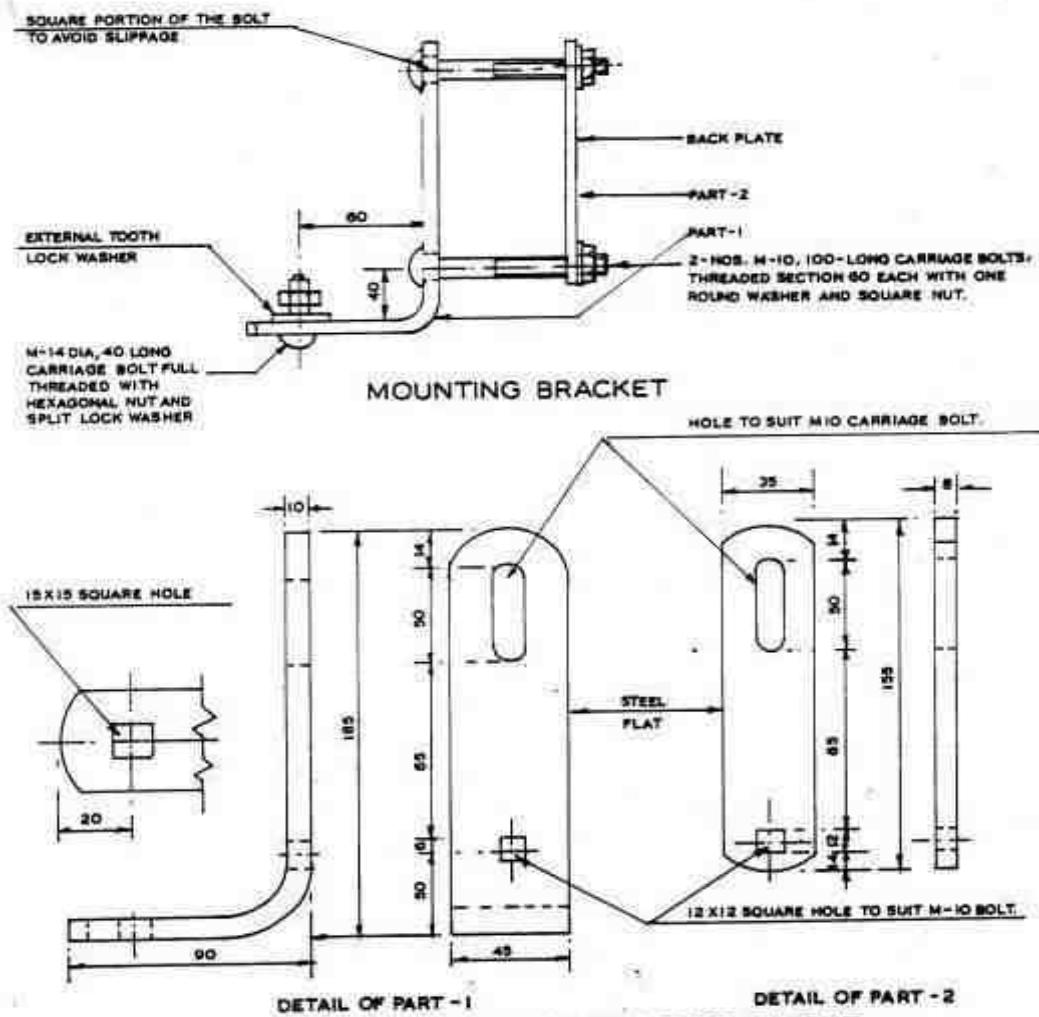

FIG.2 :- MOUNTING DETAILS OF 11KV FUSE CUTOUT

ALL DIMENSIONS ARE IN MM.

११ के. वी. ड्रॉप-आउट फ्यूज कटआउट 11KV DROP-OUT FUSE CUTOUT	
SCALE :- N.T.S	JULY, 1987



### 30. 33 & 11 kV Station Class Lightning Arrestor & 11 kV Distribution Class Surge Arrestors

#### 1. 33kV VOLTAGE CLASS SURGE ARRESTORS

Lightning Arrestors at Grid Substation shall be of Station class only in 33 & 11 KV System.

##### 1.1. INTRODUCTION

The section covers the specification of 33kV voltage level, 10 kA, and Station class heavy duty, gapless metal (zinc) oxide Surge Arrestors complete with insulating base, terminal clamps, complete fittings & accessories for installation on outdoor type 33kV switchgear/transmission lines / transformers.

##### 1.2. STANDARDS

The design, manufacture and performance of Surge Arrestors shall comply with IS: 3070 Part-3 and other specific requirements stipulated in the specification. Unless otherwise specified, the equipment, material and processes shall conform to the latest applicable Indian/International Standards as listed hereunder:

IS:2071-1993 (Part-1)	Methods of High Voltage Testing General Definitions & Test Requirements.
IS:2071-1974(Part-2)	Test Procedures
IS:2629-1985	Recommended Practice for hot dip galvanizing on Iron & Steel
IS:2633-1986	Method for Testing uniformity of coating of zinc coated Articles.
IS:3070-1993 (Part – 3)	Specification for surge arrestor for alternating current systems. Metal-Oxide lightning Arrestors without gaps
IS:4759-1996	Specification for hot dip zinc coating on Structural Steel and Other allied products.
IS:5621-1980	Hollow Insulators for use in Electrical Equipment.
IS:6209-1982	Methods of Partial discharge measurement.
IS:6745	Method for determination of mass of zinc coating on zinc coated iron and steel articles
ANSI/IEEE-C.62.11	Metal oxide, Surge Arrestor for AC Power Circuits.
IEC –60099-4	Surge Arrestors

The equipment complying with any other internationally accepted standards shall also be considered if it ensures performance equivalent to or superior to the Indian Standards.

**1.3. GENERAL REQUIREMENT**

- 1.3.1. The metal oxide gap less Surge Arrestor without any series or shunt gap shall be suitable for protection of 33kV switchgear, transformers, associated equipment and 33 kV lines from voltage surges resulting from natural disturbance like lightning as well as system disturbances.
- 1.3.2. The surge arrester shall draw negligible current at operating voltage and at the same time offer least resistance during the flow of surge current.
- 1.3.3. The surge arrester shall consist of non-linear resistor elements placed in series and housed in electrical grade porcelain housing / silicon polymeric of specified creepage distance.
- 1.3.4. The assembly shall be hermetically sealed with suitable rubber gaskets with effective sealing system arrangement to prevent ingress of moisture.
- 1.3.5. The surge arrester shall be provided with line and earth terminals of suitable size. The ground side terminal of surge arrester shall be connected with 25x6 mm galvanized strip, one end connected to the surge arrester and second end to a separate ground electrode. The bidder shall also recommend the procedure which shall be followed in providing the earthing system to the Surge Arrester.
- 1.3.6. The surge arrester shall not operate under power frequency and temporary over voltage conditions but under surge conditions, the surge arrester shall change over to the conducting mode.
- 1.3.7. The surge arrester shall be suitable for circuit breaker performing 0-0.3sec.-CO-3 min-CO- duty in the system.
- 1.3.8. Surge arrestors shall have a suitable pressure relief system to avoid damage to the porcelain/silicon polymeric housing and providing path for flow of rated fault currents in the event of arrester failure.
- 1.3.9. The reference current of the arrester shall be high enough to eliminate the influence of grading and stray capacitance on the measured reference voltage.
- 1.3.10. The arrestors for 33 kV system shall be suitable for mounting on transformers, Bus, Line & structure as per scheme. The supplier shall furnish the drawing indicating the dimensions, weights etc. of the surge arrestors for the design of mounting Structure.
- 1.3.11. The arrester shall be capable of handling terminal energy for high surges, external pollution and transient over voltage and have low losses at operating voltages.

#### 1.4. ARRESTOR HOUSING

- 1.4.1. The arrester housing shall be made up of porcelain/**silicon polymeric** housing and shall be homogenous, free from laminations, cavities and other flaws of imperfections that might affect the mechanical and dielectric quality. The housing shall be of uniform brown (**for porcelain**)/Grey (**for silicon polymeric**) colour, free from blisters, burrs and other similar defects.

Arrestors shall be complete with fasteners for stacking units together and terminal connectors.

- 1.4.2. The housing shall be so coordinated that external flashover shall not occur due to application of any impulse or switching surge voltage up to the maximum design value for arrester. The arrestors shall not fail due to contamination. The 33 kV arrestors housing shall be designed for pressure relief class as given in Technical Parameters of the specification.
- 1.4.3. Sealed housings shall exhibit no measurable leakage.

#### 1.5. FITTINGS & ACCESSORIES

- 1.5.1. The surge arrester shall be complete with fasteners for stacking units together and terminal connectors.
- 1.5.2. The terminals shall be non-magnetic, corrosion proof, robust and of adequate size and shall be so located that incoming and outgoing connections are made with minimum possible bends. The top metal cap and base of surge arrester shall be galvanized. The line terminal shall have a built in clamping device which can be adjusted for both horizontal and vertical take off.

#### 1.6. TESTS

##### 1.6.1. Test on Surge Arrestors

The Surge Arrestors offered shall be type tested and shall be subjected to routine and acceptance tests in accordance with IS : 3070 (Part-3)/IEC-60099-4. In addition, the suitability of the surge arresters shall also be established for the followings

##### i) Acceptance tests

- a) Measurement of power frequency reference voltage of arrester units.
- b) Lightning impulse residual voltage on arrester units (IEC clause 6.3.2)
- c) Internal ionization or partial discharge test

##### ii) Special Acceptance tests

- a) Thermal stability test (IEC 99-4 clause 7.2.2)
  - b) Watt loss test.
- iii) **Routine tests**
- a) Measurement of reference voltage
  - b) Residual voltage test of arrester unit
  - c) Internal ionization or partial discharge test
  - d) Sealing test
  - e) Verticality check on completely assembled surge arresters as a sample test on each lot if applicable.
- iv) **Type Tests**

Following shall be type test as per IS 3070 (Part 3): 1993 or its latest amendment.

1.	Insulation Withstand test a) Lightning Impulse b) Power Frequency (Dry/Wet)
2.	Residual Voltage Test a) Steep current impulse residual voltage test b) Lightning impulse residual voltage test c) Switching Impulse Residual voltage test
3.	Long duration current impulse withstand test
4.	Switching surge operating duty test
5.	Power frequency voltage Vs. Time characteristics
6.	Accelerated Ageing test
7.	Pressure relief test a) High Current b) Low Current
8.	Artificial pollution test (for porcelain housing)
9.	Seismic Test
10.	Partial Discharge test
11.	Bending test
12.	a) Temperature cycle test (for porcelain housing) b) Porosity test (for porcelain housing)
13.	Galvanising test on metal parts
14.	Seal Leakage test (for porcelain housing)
15.	Seal leak test and operation tests ( for surge monitor)

16.	Weather ageing test (for polymer housing)
-----	---

- 1.6.2. The maximum residual voltages corresponding to nominal discharge current of 10 kA for steep current, impulse residual voltage test, lightning impulse protection level and switching impulse level shall generally conform to **Annex-K of IEC-99-4**.
- 1.6.3. The contractor shall furnish the copies of the type tests and the characteristics curves between the residual voltage and nominal discharge current of the offered surge arrester and power frequency voltage v/s time characteristic of the surge arrester subsequent to impulse energy consumption as per clause 6.6.7 of IS:3070 (Part-3) offered along with the GTP/Drawing.
- 1.6.4. The surge arrester housing shall also be type tested and shall be subjected to routine and acceptance tests in accordance with IS: 5621.

1.6.5. **Galvanization Test**

All Ferrous parts exposed to atmospheric condition shall have passed the type tests and be subjected to routine and acceptance tests in accordance with IS:2633 & IS 6745.

1.7. **NAME PLATE**

1.7.1. The name plate attached to the arrester shall carry the following information:

- Rated Voltage
- Continuous Operation Voltage
- Normal discharge current
- Pressure relief rated current
- Manufacturers Trade Mark
- Name of Sub-station
- Year of Manufacturer
- Name of the manufacture
- Name of Client-“ “

- Purchase Order Number along with date

### 1.8. DRAWINGS AND INSTRUCTION MANUALS

Within 15 days of receipt of the order, the successful tenderer shall furnish to the purchaser the following drawings and literature for approval:

- (i) Outline dimensional drawings of Surge Arrestor and all accessories.
- (ii) Assembly drawings and weights of main component parts.
- (iii) Drawings of terminal clamps.
- (iv) Arrangement of earthing lead.
- (v) Minimum air clearance to be maintained of line components to ground.
- (vi) Name plate
- (vii) Instructions manual
- (viii) Drawing showing details of pressure relief valve
- (ix) Volt-time characteristics of surge arrestors
- (x) Detailed dimensional drawing of porcelain housing/Silicon polymeric i.e. internal diameter, external diameter, thickness, height, profile, creepage distance, dry arcing distance etc.

### 1.9. TECHNICAL PARTICULARS

- 1.9.1. The surge arrestors shall conform to the following standard technical requirements. The Insulation values shall be enhanced considering the altitude of operation & other atmospheric conditions.

#### System Parameters:

Nominal system voltage	:	33 kV
Highest system voltage	:	36 kV
System earthing	:	Solidly earthed system
Frequency (Hz)	:	50
Lightning Impulse withstand Voltage (kVP)	:	170
Power frequency withstand Voltage (kV rms)	:	70
Connection to system	:	Phase to earth

#### 1.9.2. Surge Arrestors

Type of Surge Arrestor	:	Gapless Metal oxide outdoor
Arrestor rating (kV rms)	:	30
Continuous Operating voltage (kV rms)	:	25
Standard Nominal Discharge Current Rating (kA) (8x20 micro impulse shape)	:	10
Line discharge class	:	2
Degree of protection	:	IP-67
Lightning Impulse at 10 kA	:	85
Partial discharge at 1.05 COV not greater than	:	50 (PC)
Energy capability corresponding to		
a) Arrestor rating (kJ/kV)	:	4.5
b) COV (kJ/kV)	:	4.9
Peak current for high current impulse operating duty of arrestor classification 10 kA	:	100

### 1.9.3. Insulator Housing

Power frequency withstand test voltage (wet) (kV rms)	:	70
Lightning impulse withstand/tests voltage (kVP)	:	170
Pressure Relief Class	:	40
Creepage distance not less than	:	900 mm

### 1.9.4. Galvanisation

<u>Fabricated Steel Aticles</u>		
-- 5 mm thick cover	:	610 g/m <sup>2</sup>
-- Under 5 mm but not less than 2 mm thickness	:	460 g/m <sup>2</sup>
-- Under 2 mm but not less than 1.2 mm thickness	:	340 g/m <sup>2</sup>
<u>Castings</u>		

-- Grey Iron, malleable iron	:	610 g/m <sup>2</sup>
<u>Threaded works other than tubes &amp; tube fittings</u>		
-- Under 10 mm dia		270 g/m <sup>2</sup>
-- 10 mm dia & above		300m <sup>2</sup>

## 2. 11kV VOLTAGE CLASS SURGE ARRESTORS

### 2.1. INTRODUCTION

This section covers the specification of 11kV voltage station Surge Arrestors for installation on outdoor type 11kV switchgear, transmission lines, transformers etc. 11kV side of which is not enclosed in a cable box. Station class surge arrestors shall be complete with fasteners for stacking units.

### 2.2. STANDARDS

The design, manufacture and performance of Surge Arrestors shall comply with IS: 3070 Part-3 and other specific requirements stipulated in the specification. Unless otherwise specified, the equipment, material & processes shall conform to the latest amendments of the following:

IS:2071-1993 (Part-1)	Methods of High Voltage Testing General Definitions & Test Requirements.
IS:2071-1974 (Part-2)	Test Procedures.
IS: 2629-1985	Recommended Practice for hot dip galvanizing on Iron & Steel.
IS: 2633-1986	Method for Testing uniformity of coating of zinc coated Articles.
IS:3070-1993 (Part – 3)	Specification for surge arrestor for alternating current systems. Metal-Oxide lightning Arrestors without gaps.
IS: 4759-1996	Specification for hot dip zinc coating on structural steel and other allied products.
IS: 5621-1980	Hollow Insulators for use in Electrical Equipment.
IS: 6209-1982	Methods of Partial discharge measurement.
IS: 6745	Method for determination of mass of zinc coating on zinc coated iron and steel articles.
ANSI/IEEE-C.62.11	Metal oxide, Surge Arrestor for AC Power Circuits.



IEC –60099-4	Surge Arrestors.
--------------	------------------

The equipment complying with any other internationally accepted standards shall also be considered if it ensures performance equivalent to or superior to the Indian Standards.

### 2.3. GENERAL REQUIREMENT

- 2.3.1. The metal oxide gap less Surge Arrestor without any series or shunt gap shall be suitable for protection of 11 kV side of power transformers, associated equipment and 11kV lines from voltage surges resulting from natural disturbance like lightning as well as system disturbances.
- 2.3.2. The surge arrester shall draw negligible current at operating voltage and at the same time offer least resistance during the flow of surge current.
- 2.3.3. The surge arrester shall consist of non-linear resistor elements placed in series and housed in electrical grade porcelain housing / silicon polymeric of specified Creepage distance.
- 2.3.4. The assembly shall be hermetically sealed with suitable rubber gaskets with effective sealing system arrangement to prevent ingress of moisture.
- 2.3.5. The surge arrester shall be provided with line and earth terminals of suitable size. The ground side terminal of surge arrester shall be connected with 25x6 mm galvanized strip, one end connected to the surge arrester and second end to a separate ground electrode. The bidder shall also recommend the procedure which shall be followed in providing the earthing system to the Surge Arrester.
- 2.3.6. The surge arrester shall not operate under power frequency and temporary over voltage conditions but under surge conditions, the surge arrester shall change over to the conducting mode.
- 2.3.7. The surge arrester shall be suitable for circuit breaker performing 0-0.3 min-CO-3 min-CO- duty in the system.
- 2.3.8. Surge arrestors shall have a suitable pressure relief system to avoid damage to the porcelain/ silicon polymeric housing and providing path for flow of rated fault currents in the event of arrester failure.
- 2.3.9. The reference current of the arrester shall be high enough to eliminate the influence of grading and stray capacitance on the measured reference voltage.

- 2.3.10. The Surge Arrestor shall be thermally stable and the bidder shall furnish a copy of thermal stability test with the bid.
- 2.3.11. The arrestor shall be capable of handling terminal energy for high surges, external pollution and transient over voltage and have low losses at operating voltages.
- 2.3.12. The surge arrestor shall be provided with line and earth terminals of suitable size.

#### 2.4. **ARRESTOR HOUSING**

- 2.4.1. The arrestor housing shall be made up of porcelain/**silicon polymeric** housing and shall be homogenous, free from laminations, cavities and other flaws of imperfections that might affect the mechanical and dielectric quality. The housing shall be of uniform **brown (for porcelain)/Grey (for silicon polymeric)** colour, free from blisters, burrs and other similar defects.

Arrestors shall be complete with fasteners for stacking units together and terminal connectors.

- 2.4.2. The housing shall be so coordinated that external flashover shall not occur due to application of any impulse or switching surge voltage upto the maximum design value for arrestor. The arrestors shall not fail due to contamination. The 11kV arrestors housing shall be designed for pressure relief class as given in Technical Parameters of the specification.
- 2.4.3. Sealed housings shall exhibit no measurable leakage.

#### 2.5. **ARRESTOR MOUNTING**

The arrestors shall be suitable for mounting on 4 pole/2 pole structure used for pole/plinth mounted transformer and for incoming and outgoing lines. Arrestor may also be required to be mounted on a bracket provided in the Transformers.

#### 2.6. **FITTINGS & ACCESSORIES**

- 2.6.1. The surge arrestor shall be complete with fasteners and terminal connectors.
- 2.6.2. The terminals shall be non-magnetic, corrosion proof, robust and of adequate size and shall be so located that incoming and outgoing connections are made with minimum possible bends. The top metal cap and base of surge arrestor shall be galvanized. The line terminal shall have a built in clamping device which can be adjusted for both horizontal and vertical take off.

#### 2.7. **TESTS**

### 2.7.1. Test on Surge Arrestors

The Surge Arrestors offered shall be type tested and shall be subjected to routine and acceptance tests in accordance with IS : 3070 (Part-3)-/IEC:600994. In addition, the suitability of the surge arresters shall also be established for the followings.

#### i) Acceptance tests

- a) Measurement of power frequency reference voltage of arrester units.
- b) Lightning impulse residual voltage on arrester units (IEC clause 6.3.2)
- c) Internal ionization or partial discharge test

#### ii) Special Acceptance tests:

- a) Thermal stability test (IEC clause 7.2.2)
- b) Watt loss test.

#### iii) Routine tests

- a) Measurement of reference voltage
- b) Residual voltage test of arrester unit
- c) Internal ionization or partial discharge test
- d) Sealing test
- e) Verticality check on completely assembled surge arresters as a sample test on each lot if applicable.

#### iv) Type Tests

Following shall be type test as per IS 3070 (Part 3): 1993 or its latest amendment

1.	Insulation Withstand test a) Lightning Impulse b) Power Frequency (Dry/Wet)
2.	Residual Voltage Test a) Steep current impulse residual voltage test b) Lightning impulse residual voltage test c) Switching Impulse Residual voltage test
3.	Long duration current impulse withstand test
4.	Switching surge operating duty test
5.	Power frequency voltage Vs. Time characteristics
6.	Accelerated Ageing test
7.	Pressure relief test

	c) High Current d) Low Current
8.	Artificial pollution test (for porcelain housing)
9.	Seismic Test
10.	Partial Discharge test
11.	Bending test
12.	a) Temperature cycle test (for porcelain housing) b) Porosity test (for porcelain housing)
13.	Galvanising test on metal parts
14.	Seal Leakage test (for porcelain housing)
15.	Seal leak test and operation tests ( for surge monitor)
16.	Weather ageing test (for polymer housing)

2.7.2. The maximum residual voltages corresponding to nominal discharge current of 10 kA for steep current, impulse residual voltage test, lightning impulse protection level and switching impulse level shall generally conform to Annex-K of IEC-99-4.

2.7.3. The contractor shall furnish the copies of the type tests and the characteristics curves between the residual voltage and nominal discharge current of the offered surge arrestor and power frequency voltage v/s time characteristic of the surge arrestor subsequent to impulse energy consumption as per clause 6.6 of IS:3070 (Part-3) offered alongwith the bid.

2.7.4. The surge arrestor housing shall also be type tested and shall be subjected to routine and acceptance tests in accordance with IS :5621.

**2.7.5. Galvanization Test**

All Ferrous parts exposed to atmospheric condition shall have passed the type tests and be subjected to routine and acceptance tests in accordance with IS:2633 & IS 6745.

**2.8. NAME PLATE**

2.8.1. The name plate attached to the arrestor shall carry the following information:

- Rated Voltage
- Continuous Operation Voltage
- Normal discharge current

- Pressure relief rated current
- Manufacturers Trade Mark
- Name of Sub-station
- Year of Manufacturer
- Name of the manufacture
- Name of Client-
- Purchase Order Number along with date

## 2.9. **DRAWINGS AND INSTRUCTION MANUALS**

Within 15 days of receipt of the order, the successful tenderer shall furnish to the purchaser, the following drawings and literature for approval:

- (i) Outline dimensional drawings of Surge Arrestor and all accessories.
- (ii) Assembly drawings and weights of main component parts.
- (iii) Drawings of terminal clamps.
- (iv) Arrangement of earthing lead.
- (v) Minimum air clearance to be maintained of line components to ground.
- (vi) Name plate
- (vii) Surge monitor, if applicable.
- (viii) Instructions manual
- (ix) Drawing showing details of pressure relief valve
- (x) Volt-time characteristics of surge arrestors
- (xi) Detailed dimensional drawing of porcelain housing/Silicon polymeric i.e. internal diameter, external diameter, thickness, height, profile, creepage distance, dry arcing distance etc.

## 2.10. **TECHNICAL PARTICULARS**

- 2.10.1. The surge arrestors shall conform to the following standard technical requirements. The Insulation values shall be enhanced considering the altitude of operation & other atmospheric conditions.

### **System Parameters**

- |                            |       |
|----------------------------|-------|
| i) Nominal system voltage  | 11kV  |
| ii) Highest system voltage | 12 kV |

iii)	System earthing	Effectively earthed system
iv)	Frequency (Hz)	50
v)	Lightning Impulse withstand	75 Voltage (kVP)
vi)	Power frequency withstand	28 Voltage (kV rms)
vii)	Arrestor duty	
	-- Connection to system	Phase to earth
	-- Type of equipment to be protected	transformers & switchgear

### 2.10.2. Surge Arrestors

i)	Type	Gapless Metal oxide outdoor
ii)	Arrestor rating (kV rms)	9
iii)	Continuous Operating voltage	7.65 (kV rms)
iv)	Standard Nominal Discharge Current impulse shape)	10 Rating (kA) (8x20 micro
v)	Degree of protection	IP 67
vi)	Line discharge Class	2
vii)	Steep current at 10 kA	45
viii)	Lightning Impulse at 10 kA	40
ix)	Energy capability corresponding to	
	a) Arrestor rating (kj/kV)	4.5
	b) COV (kj/kV)	4.9
x)	Peak current for high current impulse operating duty of Standard TS fo arrestor classification10 kA	100

### 2.10.3. Insulator Housing

i)	Power frequency withstand test voltage (Wet) (kV rms)	28
ii)	Lightning impulse withstand/tests voltage (kVP)	75

#### 2.10.4. Galvanisation

- i) Fabricated Steel Aticles
  - a) 5 mm thick cover 610 g/m<sup>2</sup>
  - b) Under 5 mm but not less than 2 mm thickness 460 g/m<sup>2</sup>
  - c) Under 2 mm but not less than 1.2 mm thickness 340 g/m<sup>2</sup>
- ii) Castings
  - Grey Iron, malleable iron 610 g/m<sup>2</sup>
- iii) Threaded works other than tubes & tube fittings
  - a) Under 10 mm dia 270 g/m<sup>2</sup>
  - b) 10 mm dia & above 300 g/m<sup>2</sup>

NOTE- Surge Monitor shall have to be provided if covered in BPS.

### 3. DISTRIBUTION CLASS SURGE ARRESTORS

To be used in distribution Transformer Substations only.

#### 3.1. INTRODUCTION

This section covers the specification of Distribution class Surge Arrestor for 11kV transmission lines, transformers etc.

#### 3.2. STANDARDS

The design, manufacture and performance of Surge Arrestors shall comply with IS: 3070 Part-3 and other specific requirements stipulated in the specification. Unless otherwise specified, the equipment, material and processes shall conform to the latest applicable Indian/International Standards as listed hereunder:

IS:2071- 1993 (Part-1)	:	Methods of High Voltage Testing General Definitions & Test
IS:2071-1974 (part-2)	:	Test Procedures
IS:2629-1985	:	Recommended Practice for hot dip galvanizing on Iron & Steel
IS:2633-1986	:	Method for Testing uniformity of coating of zinc coated Articles.
IS3070-1993 (Part-3)	:	Specification for surge arrestor for alternating current systems. Metal-Oxide lightning Arrestors without gaps
IS:4759-1996	:	Specification for hot dip zinc coating on Structural Steel and Other allied products.
IS:5621-1980		Hollow Insulators for use in Electrical Equipment.
IS:6209-1982		Methods of Partial discharge measurement.

IS:6745		Method for determination of mass of zinc coating on zinc coated iron and steel articles
ANSI/IEEE-C.62.11 :		Metal oxide, Surge Arrestor for AC Power (1982) Circuits.
IEC –60099-4		Surge Arrestors

3.2.1. The equipment complying with any other internationally accepted standards shall also be considered if it ensures performance equivalent to or superior to the Indian Standards.

### 3.3. GENERAL REQUIREMENT

3.3.1. The metal oxide gap less Surge Arrestor without any series or shunt gap shall be suitable for protection of 11 kV side of Distribution Transformers, associated equipment and 11 kV lines from voltage surges resulting from natural disturbance like lightning as well as system disturbances.

3.3.2. The surge arrester shall draw negligible current at operating voltage and at the same time offer least resistance during the flow of surge current.

3.3.3. The surge arrester shall consist of non-linear metal oxide resistor elements placed in series and housed in electrical grade porcelain housing / silicon polymeric of specified Creepage distance.

3.3.4. The assembly shall be hermetically sealed with suitable rubber gaskets with effective sealing system arrangement to prevent ingress of moisture.

3.3.5. The surge arrester shall be provided with line and earth terminals of suitable size. The ground side terminal of surge arrester shall be connected with 25x6 mm galvanized strip, one end connected to the surge arrester and second end to a separate ground electrode. The contractor shall also recommend the procedure which shall be followed in providing the earthing/system to the Surge Arrester.

3.3.6. The surge arrester shall not operate under power frequency and temporary over voltage conditions but under surge conditions, the surge arrester shall change over to the conducting mode.

3.3.7. The surge arrester shall be suitable for circuit breaker performing 0-0.3 min-CO-3 min-CO- duty in the system.

3.3.8. The reference current of the arrester shall be high enough to eliminate the influence of grading and stray capacitance on the measured reference voltage.



- 3.3.9. The Surge Arrestor shall be thermally stable and the contractor shall furnish a copy of thermal stability test with the bid.
- 3.3.10. The arrestor shall be capable of handling terminal energy for high surges, external pollution and transient over voltage and have low losses at operating voltages.

### 3.4. **ARRESTOR HOUSING**

- 3.4.1. The arrestor housing shall be made up of porcelain/*silicon polymeric* housing and shall be homogenous, free from laminations, cavities and other flaws of imperfections that might affect the mechanical and dielectric quality. The housing shall be of uniform **brown (for porcelain)/ Grey (for silicon polymeric)** colour, free from blisters, burrs and other similar defects.
- 3.4.2. The housing shall be so coordinated that external flashover shall not occur due to application of any impulse or switching surge voltage upto the maximum design value for arrestor. The arrestors shall not fail due to contamination.
- 3.4.3. Sealed housings shall exhibit no measurable leakage.

### 3.5. **ARRESTOR MOUNTING**

The arrestors shall be suitable for mounting on 4 pole/2 pole structure used for pole mounted transformer and for incoming and outgoing lines.

### 3.6. **FITTINGS & ACCESSORIES**

- 3.6.1. The surge arrestor shall be complete with disconnectors and terminal connectors and all other accessories.
- 3.6.2. The terminals shall be non-magnetic, corrosion proof, robust and of adequate size and shall be so located that incoming and outgoing connections are made with minimum possible bends. The top metal cap and base of surge arrestor shall be galvanized. The line terminal shall have a built in clamping device which can be adjusted for both horizontal and vertical take off.

### 3.7. **TESTS**

#### 3.7.1. **Test on Surge Arrestors**

The Surge Arrestors offered shall be type tested and shall be subjected to routine and acceptance tests in accordance with IS : 3070 (Part-3)-1993. In addition, the suitability of the surge arrestors shall also be established for the followings

- a) **Acceptance tests:**

- i) Measurement of power frequency reference voltage of arrester units.
  - ii) Lightning impulse residual voltage on arrester units (IEC clause 6.3.2)
  - iii) Internal ionization or partial discharge test
- b) **Special Acceptance tests:**
- i) Thermal stability test (IEC clause 7.2.2)
- c) **Routine tests:**  
Measurement of reference voltage
- i) Residual voltage test of arrester unit
  - ii) Internal ionization or partial discharge test
  - iii) Sealing test
  - iv) Verticality check on completely assembled surge arresters as a sample test on each lot if applicable.
- d) **Type tests:** Following shall be type test As per IS 3070 (Part 3)-/IEC;60094 or its latest amendment

1.	Insulation Withstand test a) Lightning Impulse voltage test b) Power Frequency (Dry & Wet)
2.	Residual Voltage Test a) Steep current impulse residual voltage test b) Lightning Impulse Residual Voltage Test
3.	Long duration current impulse withstand test
4.	High current impulse operating duty test
5.	Power frequency voltage Vs. Time characteristics
6.	Accelerated Ageing test
7.	Artificial pollution test (for porcelain housing)
8.	Partial discharge test
9.	Visual Examination (for porcelain housing)
10.	a) Temperature cycle test (for porcelain housing)
11.	Mechanical Failing Load test (Bending Strength test)
12.	Uniformity of Zinc coating, Mass of zinc coating

13.	Time versus current curve (for disconnector)
14.	Weather ageing test (for polymer housing)

3.7.2. The maximum residual voltages corresponding to nominal discharge current of 5 kA for steep current, impulse residual voltage test, lightning impulse protection level and switching impulse level shall generally conform to Annex-K of IEC-99-4.

3.7.3. The contractor shall furnish the copies of the type tests and the characteristics curves between the residual voltage and nominal discharge current of the offered surge arrester and power frequency voltage v/s time characteristic of the surge arrester subsequent to impulse energy consumption as per clause 6.6.7 of IS:3070 (Part-3) offered alongwith the GTP.

3.7.4. The surge arrester housing shall also be type tested and shall be subjected to routine and acceptance tests in accordance with IS: 5621

**3.7.5. GALVANIZATION TEST**

All Ferrous parts exposed to atmospheric condition shall have passed the type tests and be subjected to routine and acceptance tests in accordance with IS:2633 & IS 6745.

**3.7.6. TEST ON SURGE ARRESTOR DISCONNECTORS**

The test shall be performed on surge arrestors which are fitted with arrester disconnector or on the disconnector assembly alone if its design is such as to be unaffected by the heating of adjacent parts of the arrester in its normally installed portion in accordance with IS:3070 (Part-3)

**3.8. NAME PLATE**

3.8.1. The name plate attached to the arrester shall carry the following information:

- Rated Voltage
- Continuous Operation Voltage
- Normal discharge current
- Manufacturers Trade Mark
- Year of Manufacturer

- Name of the manufacture
- Name of Client-
- Purchase Order Number along with date

### **3.9. DRAWINGS AND INSTRUCTION MANUALS**

The successful bidder shall furnish to the purchaser the following drawings and literature for approval:

- (i) Outline dimensional drawings of Surge Arrestor and all accessories.
- (ii) Assembly drawings and weights of main component parts.
- (iii) Drawings of terminal clamps.
- (iv) Arrangement of earthing lead.
- (v) Minimum air clearance to be maintained of line components to ground.
- (vi) Name plate
- (vii) Instructions manual
- (viii) Drawing showing details of pressure relief valve
- (ix) Volt-time characteristics of surge arrestors
- (x) Detailed dimensional drawing of porcelain housing/Silicon polymeric i.e. internal diameter, external diameter, thickness, height, profile, creepage distance, dry arcing distance etc.

### **3.10. TECHNICAL PARTICULARS**

**3.10.1.** The surge arrestors shall conform to the following standard technical requirements. The Insulation values shall be enhanced considering the altitude of operation & other atmospheric conditions.

#### **System Parameters**

- i) Nominal system voltage                      11kV
- ii) Highest system voltage                      12 kV

iii) System earthing	Solidly earthed system
iv) Frequency (Hz)	50
vii) Lightning Impulse withstand	75 Voltage (kVP)
viii) Power frequency withstand	28 Voltage (kV rms)
vii) Arrestor duty	
-- Connection to system	Phase to earth
-- Type of equipment to be protected	11 kV transformers & switchgear

### 3.10.2. Surge Arrestors

i) Type	Gapless Metal oxide outdoor
ii) Arrestor rating (kV rms)	9
iii) Continuous Operating voltage (kV rms)	7.65
v) Nominal Discharge Current (micro impulse shape)	5 Rating (kA) (8x20)
v) Long Duration discharge class	Distribution class
vi) Maximum residual voltage (kV peak)	
a) at 5 kA	27
vii) Partial discharge at 1.05 COV not greater than	50 (PC)
viii) High current impulse withstand voltage at 5 kA (kVp)	65

### 3.11. INSULATOR HOUSING

i) Power frequency withstand test voltage (Wet) (kV rms)	28
ii) Lightning impulse withstand/tests voltage (kVP)	75
iii) Creepage distance not less than (mm)	300

### 3.12. GALVANISATION

i) Fabricated Steel Aticles	
a) 5 mm thick cover	610 g/m <sup>2</sup>
b) Under 5 mm but not less than 2 mm thickness	460 g/m <sup>2</sup>
c) Under 2 mm but not less than 1.2 mm thickness	340 g/m <sup>2</sup>

- ii) Castings
  - Grey Iron, malleable iron 610 g/m<sup>2</sup>
- iii) Threaded works other than tubes & tube fittings
  - a) Under 10 mm dia 270 g/m<sup>2</sup>
  - b) 10 mm dia & above 300 g/m<sup>2</sup>



### 31. LED Self Ballasted Lamps (Retrofit LED Lamp)

1. Lamp Terminology: Self Ballasted LED Lamp retrofits for GLS lamp, cap size E27.
2. Technical Requirement: The lamps shall conform to 16102 (Part 1) for safety requirements. The test method for performance requirement shall be as per IS 16102(Part 2). The performance of lamps shall be as specified in the following table.
3. LED Chip conformity should mandatory be as per LM80.
4. Lamp Specifications:

Sl. No.	Test Parameters	Requirements	Referred Standard IS/IEC
1	Rated Wattage	Upto 9 W	IS 16102 (Part 2)
2	Cap Type	E27	IS 16102 (Part 1)
3	Efficacy (lm/w)	Minimum 80 lumen/watt	IS 16102 (Part 2)
4	Minimum operating input voltage	AC 144 V to 288 V	Shall be able to operate satisfactorily
5	Rated Voltage	Up to and including 250 V AC; in case of voltage range - 220 V to 240 V, AC	
6	Rated frequency	50 Hz	IS 16102(Part 1)
7	Light Source (LED chips/Die)	COB/SMD LED	LM 80 Compliant (Certified by the supplier)
8	CCT	Cool White (Cool daylight) 5700K (5665 ± 270) to 6500K(6432±340) Colour variation category, initial and maintained-B	IS 16102 (Part 2)
9	Beam angle	Minimum 140°	IS 16102 (Part 2)
10	Power factor	Minimum 0.9°	IS 16102 (Part 2)
11	Life	Average life 25,000 hrs	IS 16102 (Part 2)
12	CRI	Minimum 70	IS 16102 (Part 2)
13	Lumen Maintenance	Maximum 10% at 25% of rated lamp life(with a maximum duration of 6000hrs).	IS 16102 (Part 2)
14	Rated Luminous flux	Minimum 710 lm	IS 16102 (Part 2)
15	Safety requirement	Lamp shall meet all the safety requirements	IS 16102 (Part 1)



16	Guarantee	Minimum 3 years	
Making		On the product of packaging 1. This lamp is specially made for distribution under RDSS scheme 2. Year of Mfr/Batch No./Serial no. 3. Name/ Address of Manufacturer 4. "Not for SALE or retail market"	Marking shall be on the carton and the product as specified in IS 16102 (Part 1) and (Part 2)
Certification endurance and switching immediately		For life, immediately self-certification to deter from sub-standard supply. Later final life test after 9 months	

5. Testing: LED lamps are tested for acceptance test as per clause 19.2, Page No.8 of IS 16102 (Part-II). The sampling of testing shall be as per clause 15, 16 & 17 of IS 16102 (Part-I).

Note- The rating of LED lamp shall be upto 9W and the lamp shall be capable to produce 710 Lumen conforming to IS 16102 (Part-II)

### 32. Earthing Coil

Earthing Coils shall be fabricated from soft GI Wire Hot Dip Galvanized. The Hot Dip galvanized wire shall have clean surface and shall be free from paint enamel or any other poor conducting material. The coil shall be made as per REC constructions standard (Refer tender drawing No. REC-XI Plan-Gen-005). The Hot Dip galvanizing shall conform to IS:2629/1966, 2633/1972 and 4826/1969 with latest amendments. Galvanizing should be heavily coated and should stand for the following tests.

#### **Galvanizing Tests**

- i) Minimum Mass of Zinc
  - a) ON GI Wire used  $280 \text{ cm/m}^2$
  - b) After Coiling –  $266 \text{ gm/m}^2$ . The certificate from recognized laboratory shall be submitted towards mass of zinc.
- ii) Dip Test Shall stand 3 dips of 1 minute and one dip of  $\frac{1}{2}$  minute before coiling and 43 dips of 1 minute after coiling as per IS : 4826/1979.

#### **THE DIMENSIONAL REQUIREMENT SHALL BE AS FOLLOWS**

- a) Nominal dia of GI Wire 4 mm (Tolerance  $\pm 2.5\%$ )
- b) Minimum no. of turns – 115 Nos.
- c) External dia of Coil (Min) – 50 mm
- d) Length of Coil (Min) – 460 mm
- e) Free length of GI Wire at one end coil (Min.) – 2500 mm

The turns should be closely bound. Weight of one finished Earthing Coils (min.) – 1.850 Kg.

Adhesion test – As per ISS 4826 – 1979.

### **33. Earthing Conductors**

All conductors burred in earth and concrete and above ground level shall be galvanised steel. Galvanised steel shall be subject to four one minute dips in copper sulphate solution as per IS:2633.

### 34. Three Phase 4 Wire L.T. Distribution Box for Aerial Bunched Conductor

#### 1 SCOPE:

- 1.1 The L.T. Distribution Box shall be used for connection through overhead conductors or ABC line and for giving connections to the consumers. This specification covers the design, manufacture, inspection, testing and supply of L.T. Distribution Box. The L.T. Distribution Box will be installed at the Poles and it shall withstand solar radiations, rain, wind pressure and pollution.

#### 2 CONSTRUCTIONAL AND TECHNICAL PARTICULARS:

- 2.1 The Distribution Box shall be made from 20 SWG CRCA MS sheet by **Deep Drawn/Sheet Bending process\*Method with Powder Coating**. Size of the box shall be 418mm x 300mm x 120mm as shown in drawing. There shall not be any welding joint to make base and cover of the Distribution box. Roof of the box shall be tapered on both sides to drain the rain water.
- \* [Amendment issued vide letter No. REC/DDUGJY/SBD/2017-18/1122 dated 15.05.2017.](#)
- 2.2 Distribution box shall have Insulated Multiple Outgoing Connectors for R, Y, B Phases and Neutral. Distribution box shall have arrangement for one incoming cable of three phase of size up to 4core 35mm<sup>2</sup>. Arrangement for four outgoing cables of size up to 4core 16mm<sup>2</sup> for three phase connection shall be provided in the distribution box. Each Incoming & outgoing cable shall be fixed inside the connection terminals by two screws of size not less than M8. The connection terminals shall be such that the outgoing cables can be fixed or removed easily without disconnecting the power supply. No current carrying part shall be approachable by hand or finger. Any current carrying part should be at a minimum distance of 5mm from the outer edge of the insulation. Insulation shall be Fire retardant.
- 2.3 Connection terminals for R, Y, and B Phases shall be mounted horizontally in a single line and Neutral shall be mounted parallel to R, Y, and B Phases in stepped pattern. Mounting arrangement shall be such that minimum clearance of 40mm is maintained between each phase and neutral. Fixing of connection terminals with the distribution box shall be preferably non-removable type to avoid theft of connection terminals.
- 2.4 Box shall be provided with U-latch sealing arrangement. A hole of 8mm & 2.5mm shall be provided in the U-latch to provide a padlock & sealing of the box respectively. U-latch shall be joined with stainless steel rivet. Box should be duly powder coated after 7-tank Phosphating process. Box should be of Light Admiralty Grey color (IS-5:1993, COLOUR NO-697). The L.T. Distribution box shall be powder coated only. The facility for 7-Tank Phosphating and powder coating shall be in-house of the tenderer to ensure proper quality, since these boxes are for outdoor applications.

- 2.5 4 Holes for incoming cables and 4 Nos. holes for outgoing cables shall be provided on the lower wall of the box. Cable holes shall be provided with rubber / plastic glands duly pasted with the box. Incoming and outgoing cable gland shall have internal diameter of 20mm. Cable Glands shall be made such that internal diameter of glands provided for cables should be closed with the film of minimum 1mm thickness. Cable will go through the cable glands by piercing the film of the glands. Gap of minimum 100mm shall be maintained between the lower wall and neutral mounted inside the distribution box for easy handling of incoming and outgoing cables.
- 2.6 **MARKING:** Following shall be provided on the cover of box.
- Manufacturers name duly embossed
  - Utility name duly embossed
  - Name of scheme duly embossed
  - Danger marking in red color.
- 2.7 M.S. Earthing Screw of diameter 6mm with washer shall be provided in the threads of the earth clamp welded to the main body of the box.
- 2.8 The box shall comply with the requirement of IP54. The box shall be fully type tested along with dimensional details as per the requirement of relevant Indian Standard (latest edition) IS13947: Part-I and latest amendments. Tests shall be carried out from laboratories which are accredited by the National Board of Testing & Calibration Laboratories (NABL) of Govt. of India to prove that the complete box meet the requirement of IP54. The tests report shall be submitted along with the tender failing which the tender of the firm shall not be opened. Government approved laboratories should be accredited by the National Board of Testing & Calibration Laboratories (NABL) of Govt. of India. The type test reports shall not be older than 5 years.
- 2.9 Distribution Box shall be duly packed in 3Ply corrugated box. The tolerance permissible on the overall dimensions of the MMB shall be ( $\pm$ ) 3%.

### **3.0 TESTS:**

Following tests shall be performed on the box during inspection:

#### **3.1 Visual Examination:**

The L.T. Distribution box will be inspected visually, externally and internally for proper Powder Coating layer, fitting of all the components in accordance with technical Specification.

#### **3.2 Verification of dimensions:**

Verification of dimensions, external / internal clearances will be carried out as per technical specifications.

#### **3.3 Verification of fittings:** Components like insulated connection terminals, screws etc will be verified as per technical specification.

3.4 **High voltage withstand test at 2.5KV:**

The A.C. voltage of 2.5KV, 50HZ shall be applied for one minute as follows:

- a) Between each Phase
- b) Between each Phase and earth screw
- c) On the insulation of connection terminals

There shall not be any puncture or flash over during this test.

3.5 **Current Carrying Capacity:** The Current of 200 AMP shall be applied for 30 minutes through high current source on the each Phase. There shall not be overheating of the terminals during this test.

### 35. Single Phase L.T. Distribution Box for Aerial Bunched Conductor

#### 1 SCOPE:

The LT Distribution box for ABC single phase is used for Connection through overhead conductors or ABC line and for giving connections to the consumers. This specification covers the design, manufacture, inspection, testing and supply of the LT Distribution box. The LT Distribution box suited for ABC single phase cable will be installed at the Poles and it shall withstand solar radiations, rain, wind pressure and pollution.

#### 2 CONSTRUCTIONAL AND TECHNICAL PARTICULARS:

2.1 The Distribution Box shall be made from 20 SWG CRCA MS sheet **with Powder Coating**. Internal size of the box shall be 225mm x 285mm x 120mm as shown in drawing. There shall not be any welding joint to make base and cover of the Distribution Box. Roof of the box shall be tapered on both sides to drain the rain water.

2.2 Distribution Box shall have insulated Multiple Outgoing Connector for Phase and Neutral. Each Multiple Outgoing Connector shall have arrangement for one incoming cable of Single phase of size up to 25mm<sup>2</sup> and 8 outgoing cables of single phase of size up to 2core 10mm<sup>2</sup>. Each Incoming & outgoing cable shall be fixed inside the Multiple Outgoing Connector by two screws of size not less than M6. The Multiple Outgoing connector shall be such that the outgoing cables can be fixed or removed easily without disconnecting the power supply. No current carrying part shall be approachable by hand or finger. Any current carrying part should be at a minimum distance of 5mm from the outer edge of the insulation. Insulation shall be Fire retardant.

2.3 Multiple Outgoing Connectors shall be mounted horizontally. Mounting arrangement shall be such that minimum clearance of 40mm is maintained between phase and neutral. Fixing of Multiple Outgoing Connectors preferably shall be non-removable type to avoid theft of connectors.

2.4 Box shall be provided with U-latch sealing arrangement. A hole of 8mm & 2.5mm shall be provided in the U-latch to provide a padlock & sealing of the box respectively. U-latch shall be joined with stainless steel rivet. Box should be duly powder coated after 7-tank Phosphating process. Box should be of Light Admiralty Grey color (IS-5:1993, COLOUR NO-697). The LT Distribution box for ABC single phase shall be powder coated only. The facility for 7-Tank Phosphating and powder coating shall be in-house of the tenderer / manufacturer to ensure proper quality, since these boxes are for outdoor applications.

2.5 One Hole for incoming cable and 8 Nos. holes for outgoing cables shall be provided on the lower wall of the box. Cable holes shall be provided with rubber / plastic

glands duly pasted with the box. Incoming and outgoing cable gland shall have internal diameter of 30mm & 15mm respectively. Cable Glands shall be made such that internal diameter of glands provided for cables should be closed with the film of minimum 1mm thickness. Cable will go through the cable glands by piercing the film of the glands. Gap of minimum 100mm shall be maintained between the lower wall and neutral mounted inside the Distribution Box for easy handling of incoming and outgoing cables.

2.6 **MARKING:** Following shall be provided on the cover of box.

- a) Manufacturers name duly embossed
- b) Utility name duly embossed
- c) Name of the scheme
- d) Danger marking in red color.

2.7 M.S. Earthing screw of diameter 6mm with washer shall be provided in the threads of the earth clamp welded to the main body of the box.

\* [Amendment issued vide letter No. REC/DDUGJY/SBD/2017-18/1122 dated 15.05.2017.](#)

The box shall comply with the requirement of IP54. The box shall be fully type tested along with dimensional drawings as per the requirement of relevant Indian Standard (latest edition) IS13947: Part-I and latest amendments. Tests shall be carried out from laboratories which are accredited by the National Board of Testing & Calibration Laboratories (NABL) of Govt. of India to prove that the complete box meet the requirement of IP54. The tests report shall be submitted along with the tender failing which the tender of the firm shall not be opened. Government approved laboratories should be accredited by the National Board of Testing & Calibration Laboratories (NABL) of Govt. of India. The type test reports shall not be older than 5 years. In case order is placed on a firm, no change in design / manufacturer of LT Distribution box shall be allowed in supplies.

2.8 Box shall be duly packed in 3Ply corrugated box. The tolerance permissible on the overall dimensions shall be ( $\pm$ ) 3%.

### 3 TESTS:

Following tests shall be performed on the box during inspection:

#### 3.1 Visual Examination: -

The LT Distribution box for ABC single phase will be inspected visually, externally and internally for proper Powder Coating layer, fitting of all the components in accordance with technical Specification.

#### 3.2 Verification of dimensions: -

Verification of dimensions, external / internal clearances will be carried out as per technical specifications.

#### 3.3 Verification of fittings: -



Components like insulated Multiple Outgoing Connectors, screws etc will be verified as per technical specification.

3.4 **High voltage withstand test at 2.5KV:** -

The A.C. voltage of 2.5KV, 50HZ shall be applied for one minute as follows:

- a) Between Phase & Neutral
- b) Between Phase and earth screw
- c) On the insulation of Multiple Outgoing Connectors.

There shall not be any puncture or flash over during this test.

3.5 **Current Carrying Capacity:** -

The Current of 200 AMP shall be applied for 30 minutes through high current source on each Multiple Outgoing Connector. There shall not be overheating of the terminals during this test.

### 36. Earthing

(AS PER IS 3043-1987)

Earthing shall generally be carried out in accordance with the requirements of Indian Electricity Rules 2003 amended from time to time and relevant regulations under Electricity Supply Authority concerned.

In case of high and extra high voltages, the neutral points shall be earthed by not less than two separate distinct connections with earth, each having its own electrodes sub-station and will be earthed at any other point provided no interference is caused by such earthing. If necessary, the neutral may be earthed through suitable impedance.

As far as possible, all earth connections should be visible for inspection. Each earthing system shall be so designed, that, the testing of individual earth electrodes is possible. It is recommended that the value of any earth system resistance shall be such as to conform to the degree of shock protection desired.

It is recommended, that a drawing showing the main earth connections and earth electrodes be prepared for each installation and submitted to Employer.

No addition to the current carrying system, either temporary or permanent, shall be made which will increase the maximum available fault current on its duration until it has been ascertained that the existing arrangement of earth electrodes, earth bus-bar etc., are capable of carrying the new value of earth fault current which may be obtained by this addition.

All materials, fittings etc., used in earthing shall conform to Indian Standard Specifications, wherever they exist.

#### **GENERAL REQUIREMENTS AND PROCEDURES FOR EARTHING AT SUB-STATIONS.**

The ground resistance for sub-stations should not exceed a value 2(two) ohms. The joints/connections in the earthing, system shall be welded only, except the connections, which require opening for testing/maintenance. Such connections should be bolted tightly, using spring and ring washers for proper contact pressure. The G.S. flats to be provided for the horizontally laid earth grid should have overlap welded joints, with length of welding at least twice the width of the flat, e.g., 100 MM for 50x6 MM G.S. flats. There should not be any dirt, grease, oil, enamel, paint or any such non-conductive coatings on the surfaces being joined/connected. Only the finished joints/connections above ground may be provided with red-oxide or any other protective coating. Underground earth electrodes and earth grid elements, when laid, should have a clean metallic surface, free from paint, enamel, grease or any such non-conductive coatings.

As far as possible, all earth connections should be accessible for visual inspection. No cut-outs, links or switches, other than linked switches arranged to operate simultaneously on the earthed or earthed neutral conductor and the live wire shall be inserted in the supply system. Earth electrodes or mate should not be installed in close proximity to metal fence to avoid possibility of fence becoming live. Separate

earth electrodes, isolated from the earth grid, are to be provided for grounding the fence wires.

Pipes or rods used as electrodes should be in one piece, as far as possible, with a minimum allowable length of 3 mtrs. Except where rock or hard stratum is encountered, the pipe/rod electrodes should be driven into the ground to a minimum depth of 3 mtrs. The strip electrodes, forming the horizontal grid, should be buried underground to a minimum depth of 0.5 mtrs. The path of earth wire should be out of normal reach of any person, as far as possible.

For high resistivity soils, above 100 Ohm-mtrs., attempts should be made to bring the soil resistivity in the range of 50 to 60 Ohm-mtrs. By digging and treating the soil mass around the earth grid/electrodes with a mixture of salt and charcoal.

In case of rocky top soil and sub-stratum, having very high resistivity, with no scope of improvement by other means, the procedure given below should be followed:

- 1.** At least two bores of diameter little less than 40 mm, with a minimum distance of 10 mtrs. between them, should be made in the ground at suitable locations inside the S/S yard. The boring should be done until soil sub-stratum rich in moisture and low in resistivity is encountered. G.I. pipes of 40 MM dia. should be descended in each bore, such that, the soil mass around the pipes grips them tightly, Back – filling of bores, if required, with wet soil/clay may be done to ensure this condition. The G.I. pipes in these deep bores should be interconnected with the main earthing grid of the S/S through 50x6 mm G.S. flat, with all the joints/connections and terminations being either fully welded, or clamped/bolted and welded simultaneously. The G.I. pipes in the bores should also be interconnected with each other. In extreme cases, the bores may have to be made at remote locations i.e. outside the S/S yard, with inter-connections, through 50x6 MM flats, as explained before.
- 2.** The procedures to be observed stringently for making connections and joints between various elements of the earthing system are as follows:
  - a.** G.S. flat to Structure/flat - The G.S. flat should be welded to the metallic portion (leg) of the structure after thoroughly cleaning the surfaces to be welded. The length of the welding should be at least twice the width of the G.S. flat, e.g.-minimum 100 mm for 50x6 mm G.S. flat. Exactly similar procedure is to be adopted for joints between two G.S. flats.
  - b.** G.I. wire to structure. The G.I. wire should be bolted to the structure after making an eye formation and kept tight with the help of spring and ring washer. Then, the entire arrangement should be welded.
  - c.** G.I. wire to G.S. flat- The G.I. wire should be bolted and then welded to G.S. flat, as explained above.
  - d.** G.I. rod to G.S. flat- The G.I. rod should be securely clamped to the G.S. flat with the help of bolts and washers and the entire arrangement should then be welded.

- e. G.I. wire to G.I. pipe – GI wire should be bolted to the G.I. pipe and then welded, keeping in view the relevant precautions, mentioned before.
- f. G.I. flat to G.I pipe – The GI flat should be bolted tightly to the G.I. pipe and then the connection should be welded.

Before making connections and joints, it should be ensured that, the elements to be joined have a clean metallic contact surface without any non-conductive coating.

### **EARTH GRID SYSTEM**

Grid system of interconnected conductors forming a closed loop mesh is to be installed using 75x8 mm MS flat for peripheral and branch conductors. Interconnections are made by welding them. This earth grid will be laid at a depth of about 0.5 mtr. bonded to general mass of the earth by 3 mtrs. long earth electrode of solid MS rod (or pipe) of dia 25mm. The G.I. pipe 40 mm. dia 3 mtrs. long in the earthing pits, driven vertically.

It is to this earth grid that the transformer neutral, apparatus, frame work and other non-current carrying metal work associated like transformer tank, switchgear frame etc. are to be connected. All these connections should be made in such a way that reliable and good electrical connection is ensured. Aluminum/ other paint, enamel, grease and scale should be removed from the point of contact before connections are made. No part of the ground connection leads should be embedded in concrete.

Arrangement of connection of earth connection shall be as follow:

#### **1. STRUCTURES:**

Structures including frames, metal supports within the substation grid at least two legs, preferably diagonally opposite (where more than two legs are provided) on each metal structure shall be connected to earth grid with GI wire of 4mm dia or 6 mm dia.

#### **2. ISOLATORS/ SWITCHES:**

The operating handle shall be connected to earth grid independent of the structure earthing or through the steel mounting structure, through 4 mm dia G.I. wire.

#### **3. LIGHTNING ARRESTOR:**

The bases of lightning arrestors shall be directly connected to the earth electrodes by 4 or 6 SWG G.I. wires as short and as straight as practicable, to ensure minimum impedance. Separate earth leads should be used for L.A. in each phase. In addition there shall be as direct connections as practicable from the earthed side of the lightning arrestors to the frame of the apparatus being protected. Surge counters, could also be inserted in the circuit where lightning incidences are high, but in such cases, the lightning arrestor should be mounted on insulated base. Invariably, earth connections for lightning

arrestors should be separate, and in no case should they be joined looped or meshed with other conductors. For lightning arrestors mounted near transformers, earthing connections shall be done with the earthing pits and earthing leads shall be laid clear of the tank and collars in order to avoid possible oil leakage caused by arcing. The earth connection should not pass through iron pipes, as it would increase the reactive impedance of the connection.

**4. POWER TRANSFORMER:**

- The tank of the transformer shall be directly connected to the main earth grid. In addition there shall be a separate and as direct a connection as practicable from the tank to the earth side of protecting LA using 4 or 6 SWG GI wire.
- The earthing of the neutral shall be by two separate, distinct and direct connections of 50x6 mm GS flat to earth pits, which form a part of the earth grid, and shall be run clear of the tank and collars.
- The transformer track rails shall be connected to earth

**5. OUT DOOR VCB:**

At least two legs, preferably diagonally opposite of the supporting structure frame work of each circuit breaker unit shall be connected to the earth grid, through 50x6 mm G.S. flats.

**6. FENCING:**

Fencing and gate should be earthed separately.

**7. CURRENT TRANSFORMERS / POTENTIAL TRANSFORMERS:**

The bases of the current transformers should be directly connected to the earth grid through 4 or 6 SWG G.I. wires. The base (neural side) of the P.Ts. should be directly connected to the earth grid through 4 or 6 SWG G.I. wires. Separate earth leads should be used for P.Ts. in each phase. The termination of leads on the P.T. neutral should be bolted/clamped and not welded, to facilitate opening of the earth connection for testing purposes. In addition, all bolted cover plates to which bushings are attached, should be connected to the earth grid, both in case of C.Ts. and P.Ts.

- 8.** Armoring of armored metal-sheathed cables within the station grid area shall be connected to the earth grid.

9. Substation L.T. Supply Transformer: Same as above except that the neutral earthing conductor used shall be 4 or 6 SWG G.I. wire.

### 37. GI Earthing Pipe

Earthing pipe should be made of 40 mm diameter ISI marked B class GI Pipe. 12 mm dia suitable holes on its circumference shall be made as per approved drawing. The pipe should be in one piece. No joints or welding would be allowed on its length. Clamps made of 50x6mm GI flat duly drilled with 12 mm size holes should be welded at the top end for connection of earth conductor.

Pipe used shall be 40mm NB diameter, ISI marked Galvanized Mild Steel Tubes continuously welded Electric Resistance Welded ERW/High Frequency Induction welded (HFIW)/Hot finished welded (HFW) type, conforming to IS-554-1985 with latest amendment of MEDIUM quality (Class B).

#### 1. MANUFACTURE:

GI earth pipe (40 mm diameter & 3 metre long) shall be made of tubes which shall be made from tested quality steel manufactured by any approved process as follows:

- a) Electric Resistance Welded (ERW).
- b) High Frequency Induction Welded (HFIW) and
- c) Hot finished Welded (HFW).

Tubes made by manual welding are not acceptable.

#### 2. DIMENSIONS:

The dimensions and weights of tubes shall be in accordance with Table-I and Table-II of IS: 1239 (Part-I)/1990 with latest amendments, subject to tolerance permitted therein. Necessary 12 mm diameter holes across the circumference shall be provided as per approved drawing. Drawings shall be approved by the owner before start of the manufacturing work. The tube, earthing pipe shall be provided with 50x6mm GS clamps on one end, one clamp is to be welded with the pipe and another is removable to enable measurement of earth resistance of the pit. Other end of the earth pipe should be cut half in slop to make it a sharp.

#### 3. GALVANIZING:

Tubes shall be galvanized in accordance with IS-4736-1986 with latest amendment for not dip zinc coating of Mild Steel Tubes. The minimum mass of zinc coating on the tubes shall be in accordance with clause 5.1 of IS-4736-1986 (specification for hot dip zinc) and when determined on a 100mm long test piece in accordance with IS: 6745:1972 shall be 400 g/m<sup>2</sup>. The zinc coating shall be uniform adherent reasonably smooth and free from such imperfections as flux, ash and dross inclusions, bare patches, black spots, pimples, lumpiness, rust, stains, bulky white deposits and blisters.

#### 4. HYDRAULIC TEST:

(Before applying holes) Each tube shall withstand a test pressure of 5 M Pa maintained for at least 3 seconds without showing defects of any kind. The pressure shall be applied by approved means and maintained sufficiently long for proof and inspection. The testing apparatus shall be fitted with an accurate pressure indicator

**5. TEST ON FINISHED TUBES AND SOCKETS:**

The following tests shall be conducted by the manufacturer of finished tubes and sockets.

- a) The tensile strength of length of strip cut from selected tubes when tested in accordance with IS-1894-1972, (Method for tensile testing of steel tubes), shall be at least  $320\text{N/mm}^2$ .
- b) The elongation percentage on a gauge length of  $5.65/s_0$  (where  $s_0$  is the original cross-sectional area of test specimen) shall not be less than 20%.
- c) When tested in accordance with IS-2329-1985 (Method for Bend test on Metallic tubes) the finished tube shall be capable of with standing the bend test without showing any sign of fracture or failure. Welded tubes shall be bent with the weld at 90 degree to the plane of bending. The tubes shall not be filled for this test.
- d) Galvanized tubes shall be capable of being bent cold without cracking of the steel, through 90 degree round a former having a radius at the bottom of the groove equal to 8 times the outside diameter of tube.
- e) Flattening Test on Tubes above 50 mm Nominal Bore: Rings not less than 40 mm in length cut from the ends of selected tubes shall be flattered between parallel plates with the weld, if any, at 90 degree (point of maximum bending) in accordance with IS-2328-1983. No opening should occur by fracture in the weld unless the distance between the plate is less than 75 percent of the original outside diameter of the pipe and no cracks or breaks in the metal elsewhere than in the weld shall occur, unless the distance between the plates is less than 60% of the original outside diameter. The test rings may have the inner and outer edges rounded.
- f) GALVANISHING TEST:
  - Weight of zinc Coating: For tubes thickness upto 6 mm the minimum weight of zinc coating, when determined on a 100 mm long test piece in accordance with IS-4736-1986 shall be  $400\text{ grm/m}^2$ .



- The weight of the coating expressed in  $\text{gram/m}^2$  shall be calculated by dividing the total weight of the zinc (inside plus outside) by the total area (inside plus outside) of the coated surface.
  - Test specimen for this test shall be cut approximately 100 mm in length from opposite ends of the length of tubes selected for testing. Before cutting the test specimen, 50 mm from both ends of the samples shall be discarded.
- g) Free Bore Test: A rod 230mm long and of appropriate diameter shall be passed through relevant nominal bore of the sample tubes to ensure a free bore.
- h) Uniformity of Galvanized Coating: The galvanized coating when determined on a 100 mm long test piece [see V (a) (iii)] in accordance with IS-2633-1986 (Method for testing uniformity of coating on zinc coated articles) shall with stand 4 one minute dips.

## **6. WORKMANSHIP:**

The tubes shall be cleanly finished and reasonably free from injurious defects. They shall be reasonably straight, free from cracks, surface flaws, laminations, and other defects, both internally and externally. The screw tubes and sockets shall be clean and well-cut. The ends shall be cut cleanly and square with the axis of tube.

## **7. MARKING:**

The medium class of tubes shall be distinguished by Blue colour bands which shall be applied before the tubes leaves the manufacturers' works. Tubes shall be marked with the standard mark.

### 38. GS Stay Sets (16 mm AND 20 mm)

#### 1. 16MM DIA STAY SETS (GALVANIZED)

The stay sets (Line Guy set) will consist of the following components:-

- a) **ANCHOR ROD WITH ONE WASHER AND NUT:** Overall length of rod should be 1800 mm to be made out of 16 mm dia GS Rod, one end threaded upto 40mm length with a pitch of 5 threads per cm and provided with one square GS washer of size 40x40x1.6mm and one GS hexagonal nut conforming to IS:1367:1967 & IS:1363:1967. Both washer and nut to suit threaded rod of 16mm dia. The other end of the rod to be made into a round eye having an inner dia of 40mm with best quality welding.
- b) **ANCHOR PLATE SIZE 200x200x6MM:** To be made out of GS plate of 6mm thickness. The anchor plate should have at its centre 18mm dia hole.
- c) **TURN BUCKLE & EYE BOLT WITH 2 NUTS:** To be made of 16mm dia GS Rod having an overall length of 450 mm, one end of the rod to be threaded upto 300 mm length with a pitch of 5 threads per cm and provided with two GS Hexagonal nuts of suitable size conforming to IS:1363:1967 & IS:1367:1967. The other end of rod shall be rounded into a circular eye of 40mm inner dia with proper and good quality welding.
- d) **BOW WITH WELDED ANGLE:** To be made out of 16mm dia GS rod. The finished bow shall have an overall length of 995mm and height of 450 mm, the apex or top of the bow shall be bent at an angle of 10 R. The other end shall be welded with proper and good quality welding to a GS angle 180mm long having a dimension of 50x50x6mm. The angle shall have 3 holes of 18mm dia each.
- e) **THIMBLE:** To be made on 1.5 mm thick GS sheet into a size of 75x22x40mm and shape as per standard shall be supplied.
- f) **Galvanizing:** The complete assembly shall be hot dip galvanized.
- g) **WELDING:** The minimum strength of welding provided on various components of 16mm dia stay sets shall be 3100 kg. Minimum 6 mm fillet weld or its equivalent weld area should be deposited in all positions of the job i.e. at any point of the weld length. The welding shall be conforming to relevant IS: 823/1964 or its latest amendment. Minimum length of weld to be provided at various places in the stay sets shall be indicated by the bidder. Welding if, found short in lengths as per final approved drawings shall be rejected.

- h) **THREADING:** The threads on the Anchor Rod, Eye Bolt & Nuts shall be as per specification IS: 4218:1967 (ISO Metric Screw Threads). The nuts shall be conforming to the requirement of IS: 1367:1967 & have dimensions as per IS: 163:1967. The mechanical property requirement of fasteners shall conform to property clause 4.6 each for anchor rod & Eye bolt and property clause 4 for nuts as per IS: 1367:1967.

AVERAGE WEIGHT OF FINISHED 16MM STAY SETS 7.702 KG.  
(MINIMUM) (EXCLUDING NUTS THIMBLES AND WASHERS) 8.445 KG.  
(MAXIMUM)

## 2. 20 MM DIA STAYS SETS FOR 33KV LINES (GALVANIZED)

THE STAY SET (LINE GUY SET) WILL CONSIST OF THE FOLLOWING COMPONENTS:

- a) **ANCHOR ROD WITH ONE WASHER AND NUT:** Overall length of Rod should be 1800mm to be made out of 20mm dia GS Rod, one end threaded upto 40mm length with a pitch of a threads per cm. And provided with one square G.S. Washer of Size 50x50x1.6mm and one GS Hexagonal nut conforming to IS:1367:1967 & IS:1363:1967. Both washer & nut to suit the threaded rod of 20mm. The other end of the rod to be made into a round eye having an inner dia of 40mm with best quality welding. Dimensional and other details are indicated and submitted by bidders for owner's approval before start of manufacturing.
- b) **ANCHOR PLATE:** Size 300x300x8mm: To be made out of G.S. Plate of 8mm thickness. The anchor plate to have at its centre 22mm dia hole.
- c) **TURN BUCKLE, EYE BOLT WITH 2 NUTS:** To be made of 20mm dia G.S. Rod having an overall length of 450 mm. One end of the rod to be threaded upto 300mm length with a pitch of 4 threads per cm. The 20mm dia bolt so made shall be provided with two G.S. Hexagonal nuts of suitable size conforming to IS:1637/1967 & IS:1363/1967.

The other end of the rod shall be rounded into a circular eye of 40mm inner dia with proper and good quality of welding. Welding details are to be indicated by the bidder separately for approval.

- d) **BOW WITH WELDED CHANNEL:** To be made out of 16mm dia G.S. Rod. The finished bow shall have an overall length of 995 mm and height of 450 mm. The apex or top of the bow shall be bent at an angle of 10R. The other end shall be welded with proper and good quality welding to a G.S. Channel 200mm long having a dimension of 100x50x4.7 mm. The Channel shall have 2 holes of 18 mm dia and 22 dia hole at its centre.

- e) **THIMBLE 2 Nos.:** To be made of 1.5mm thick G.S. sheet into a size of 75x22x40mm and shape as per standard.
- f) **GALVANISING:** The complete assembly shall be hot dip galvanised.
- g) **WELDING:** The minimum strength of welding provided on various components of 20mm dia stay sets shall be 4900 kg. Minimum 6mm fillet weld or its equivalent weld area should be deposited in all positions of the job i.e. at any point of the weld length. The welding shall be conforming to relevant IS: 823/1964 or its latest amendment.
- h) **THREADING:** The threads on the Anchor Rods, Eye Bolts and Nuts shall be as per specification IS: 4218:1967 (ISO Metric Screw Threads). The Nuts shall be conforming to the requirements of IS: 1367:1967 and have dimension as per IS 1363:1967. The mechanical property requirement of fasteners shall confirm to the properly clause 4.6 each for anchor rods and Eye bolt and property clause 4 for nuts as per IS: 1367:1967.

AVERAGE WEIGHT OF FINISHED 20MM STAYS SET: 14.523 KG. (MIN.)  
(EXCLUDING NUTS THIMBLE & WASHER): 15.569 KG. (MAX.)

3. **TEST CERTIFICATE:** The contractor shall be required to conduct testing of materials at Govt./Recognized testing laboratory during pre – dispatch inspection for Tensile Load of 3100 Kg/4900 Kg. applied for one minute on the welding & maintained for one minute for 16 mm and 20 mm dia stay sets respectively.
4. **IDENTIFICATION MARK:** All stay sets should carry the identification mark of word RDSS and size of the stay set. This should be engraved on the stay plate and on stay rods to ensure proper identification of the materials.

The nuts should be of a size compatible with threaded portion of rods and there should be no play or slippage of nuts.

Welding wherever required should be perfect and should not give way after erection.

5. **TOLERANCES:** The tolerances for various components of the stay sets are indicated below subject to the condition that the average weight of finished stay sets of 16mm dia excluding nuts, thimbles and washers shall not be less than the weight specified above :-

No. Item	Section	Fabrication Tolerances	Material
----------	---------	------------------------	----------

	<b>Tolerances</b>		
1 Anchor Plate	6mm thick + 12.5% - 5%	200x200mm + 1%	GS plate 6mm thick
	8mm thick + 12.5% - 5%	300x300mm + 1%	GS plate 8mm thick
2 Anchor Rod	16mm dia + 5%- 3%	Length 1800mm + 0.5%	GS Round 16mm dia
		Rounded Eye 40 mm inside dia + 3%. Threading 40mm+11% - 5	GS Round 16mm dia
	20mm dia + 3%- 2%	Length 1800mm + 0.5%	GS Round 20mm dia
		Round Eye 40mm inside dia + 3%. Threading 40mm +11% -5%	GS Found 20mm dia
3 Turn Buckle Bow	16 mm dia + 5%- 3%	Length 995mm + 1% 16mm dia	GS Round 16mm dia
		Length 180mm + 1% 50x50x6mm	GS Angle
		Channel length 200mm + 1%	GS Channel 100x50x4.7m m
4 Eye Bolt Rod	16mm dia + 5%- 3%	Length 450mm + 1% Threading 300mm + 1% Round Eye 40mm inside dia + 3%	GS Round 16mm dia
	20mm dia + 3%- 2%	Length 450mm + 1% Threading 300mm + 1% Round Eye 40mm inside dia + 3%	GS Round 20mm dia

## **39. GI Stay Wires**

### **1. SCOPE**

This Specification covers details of G.I. stranded stay wires for use in rural distribution system.

### **2. APPLICABLE STANDARDS**

Except when they conflict with the specific requirements of this specification, the G.I. Stranded Wires shall comply with the specific requirements of IS:2141-1979, IS:4826-1979 & IS:6594-1974 or the latest versions thereof.

### **3. APPLICATION AND SIZES**

**3.1** The G.I. stranded wires covered in this Specification are intended for use on the overhead power line poles, distribution transformer structures etc.

**3.2** The G.I. stranded wires shall be of 7/2.5mm, 7/3.15mm and 7/4.0mm standard sizes.

### **4. MATERIAL**

The wires shall be drawn from steel made by the open hearth basic oxygen or electric furnace process and of such quality that when drawn to the size of wire specified and coated with zinc, the finished strand and the individual wires shall be of uniform quality and have the properties and characteristics as specified in this specification. The wires shall not contain sulphur and phosphorus exceeding 0.060% each.

### **5. TENSILE GRADE**

The wires shall be of tensile grade 4, having minimum tensile strength of 700 N/mm<sup>2</sup> conforming to IS:2141.

### **6. GENERAL REQUIREMENTS**

**6.1** The outer wire of strands shall have a right-hand lay.

**6.2** The lay length of wire strands shall be 12 to 18 times the strand diameter.

## 7. MINIMUM BREAKING LOAD

The minimum breaking load of the wires before and after stranding shall be as follows :

No. of wires & const.	Wire dia (mm)	Min. breaking load of Single wire before stranding (KN)	Min. breaking load of the standard wire (KN)
7(6/1)	2.5	3.44	22.86
7(6/1)	3.15	5.45	36.26
7(6/1)	4.0	8.79	58.45

## 8. CONSTRUCTION

- 8.1** The galvanised stay wire shall be of 7-wire construction. The wires shall be so stranded together that when an evenly distributed pull is applied at the ends of completed strand, each wire shall take an equal share of the pull.
- 8.2** Joints are permitted in the individual wires during stranding but such joints shall not be less than 15 metres apart in the finished strands.
- 8.3** The wire shall be circular and free from scale, irregularities, imperfection, flaws, splits and other defects.

## 9. TOLERANCES

A tolerance of ( $\pm$ )2.5% on the diameter of wires before stranding shall be permitted.

## 10. SAMPLING CRITERIA

The sampling criteria shall be in accordance with IS:2141.

## 11. TESTS ON WIRES BEFORE MANUFACTURE

The wires shall be subjected to the following tests in accordance with IS:2141.

- i) Ductility Test

- ii) Tolerance on Wire Diameter

## 12. TESTS ON COMPLETED STRAND

The completed strand shall be tested for the following tests in accordance with IS:2141.

- a) Tensile and Elongation Test :

The percentage elongation of the stranded wire shall not be less than 6%.

- b) Chemical analysis

- c) Galvanising Test :

The Zinc Coating shall conform to "Heavy Coating" as laid down in IS:4826

## 13. MARKING

Each coil shall carry a metallic tag, securely attached to the inner part of the coil, bearing the following information:

- a) Manufacturers' name or trade mark
- b) Lot number and coil number
- c) Size
- d) Construction
- e) Tensile Designation
- f) Lay
- g) Coating
- h) Length
- i) Mass
- j) ISI certification mark, if any

## 14. PACKING

The wires shall be supplied in 75-100 Kg. coils. The packing should be done in accordance with the provisions of IS:6594.



#### 40. MCCB

The MCCBs provided in these boxes shall conform in all respects to the relevant IS: 2516 (Pt-I&II)/1977 or its latest revision as applicable.

##### **REQUIREMENT OF MCCBs:**

The moulded case circuit breakers should comprise of a switching mechanism, an effective extinguishing device and a tripping unit contained in a compact moulded case cover made of high strength, heat resistance and flame retardant thermo-insulating materials. They should comprise of a spring assisted quick make/quick break type independent manual trip free mechanism rendering it easy to manually operate the MCCBs and capable of clearly indicating "TRIPPED", "ON" AND "OFF" positions from the position of the operating handle. The contact tips should be made of a suitable alloy having high arc resistance and a long electrical and mechanical life needing no replacement. The breakers should be designed with a common trip bar to break and make all the three phase together even when fault occurs on any of the phases. The breakers should provide protection against sustained overloads and short circuits through thermal-magnetic/fully magnetic releases. These MCCBs along with terminal blocks are intended to be housed in the distribution boxes made out of sheet steel of 2mm gauge. The assembly of the MCCBs and the terminal blocks should be compact, reliable from operation point of view and safe to the operating personnel. As already mentioned earlier, the MCCBs should be fully maintenance free.

##### **TECHNICAL PARTICULARS OF MCCBs:**

The LT MCCBs should have inverse current/time characteristics suitable for protection of 63KVA, 100KVA, 200KVA & 315KVA 11.0.4KV Distribution Transformers against sustained over-loads and short circuits for following operating conditions:-

i	Rated Operating Voltage	3 Phase 415 Volts AC 50 cycles with neutral solidly grounded system
ii	Standard rated current ratings for MCCBs to be used with different sizes of transformers will be as follows:-	
a)	For 63KVA 11/0.4KV Dist. Transformer	90 Amps
b)	For 100KVA 11/0.4KV Dist. Transformer	140 Amps
c)	For 200KVA 11/0.4KV Dist. Transformer	300 Amps
d)	For 315KVA 11/0.4KV Dist.	450 Amps

	Transformer	
iii	No. of Poles	3
iv	Duty	Un-interrupted
v	Maximum ambient temperature	47°C in shade
vi	Minimum ambient temperature	4°C in shade
vii	Average altitude	A maximum of 1000 meter
viii	Maximum humidity	Frequently approaches saturation point

#### **TIME/CURRENT CHARACTERISTICS:**

The circuit breakers shall have time/current characteristics suitable for following operating conditions :-

Multiple of normal current rating	Tripping time
1.1 times	After 4 hours
1.2 times	Less than 50 minutes
1.3 times	Less than 30 minutes
1.4 times	Less than 10 minutes
2.5 times	Less than 1 minute
6 times	Less than 40 mili-seconds
12 times	Less than 40 mili-seconds

Time/Current characteristic of the Circuit Breaker (MCCB) shall be tested in accordance with Clause-7.7.2.3 (b) (2) of IS:2516-(Pt-I&II) Sec.I/1977 and the test shall be made with all the three phases loaded.

For time/current characteristic, the reference calibration temperature of the MCCBs shall be 40°C and durance, if any, upto 50°C operating temperature in the enclosure shall not exceed 10% of the value indicated above in Clause (I) above.

The MCCBs shall be calibrated and adjusted in the factory itself for the desired time/current characteristic.

The MCCB should have the following maximum resetting time under overload & short circuit conditions :-

Overload conditions	-	3 minutes
Short Circuit conditions	-	Instantaneous

#### **RATED SHORT CIRCUIT BREAKING CAPACITY:**

The rated short circuit breaking capacity of the MCCBs shall be as follows: -

Transformer rating(KVA)	Rated short circuit breaking capacity of the breaker in Kilo-Amps
63 KVA	A minimum of 3 Kilo-Amps
100 KVA	A minimum of 5 Kilo-Amps
200KVA	A minimum of 10 Kilo-Amps
315KVA	A minimum of 15 Kilo-Amps

The short circuit breaking capacity test as specified above shall be based on short circuit tests carried out at 0.4 Power Factor (lagging). For the purpose of these tests, the following operating sequence shall be followed: -

Break-3 minutes interval-Make-Break-3 minutes interval-Make-Break.

#### 41. H.R.C. Fuse

The H.R.C. fuse links of 100 Amp, 200 Amp, 300 Amp ratings, should be ISI marked & conforming to ISS: 9224-1979 with latest amendment and to be supplied with suitable base of bakelite on DMC. The knife contact should be made of tinned/silver plated copper complete with extension strips. The extension strips should be made of copper. The thickness of the copper strips should be 2mm for 100 Amp and 200 Amp, 3.0mm for 300 Amp. The strips should be in one piece. The HRC Fuse units should also be supplied with suitable lugs for 3 core 95 sq.mm, 120 sqmm and 300 sq.mm. cables for 100, 200 and 300 Amps ratings respectively. The dimension of the lugs should be as under

S.No	Ratings of HRC Fuse unit	Cable sizes	Minimum thickness of lugs Flat (mm) / Rounded (mm)	Minimum total length of lugs (mm)
1	100 Amp	95 sq.mm	4.2 / 2.1	64
2	200 Amp	120 sq.mm	4.6 / 2.3	73
3	300 Amp	300 sq.mm	7.0 / 3.5	15

The knife contact should have pressure springs to hold the fuse links. The extension strips shall be provided with GI nut & bolts and plain and spring washer to both the end. The DMC or bakelite base should be provided with suitable fixing alignment.

The following test certificates should invariably to be performed on the HRC Fuse Units.

1. Test for temperature rise at rated current
2. Current time characteristics
3. Determination of minimum fusing current and minimum non-fusing current
4. Test for duty

The breaking capacity of HRC Fuse Units should not be less than 80 KA.

The following tests shall be performed during pre-despatch inspection at manufacturer's works: -

1. Insulation resistance test
2. Temperature rise test
3. High Voltage test

Marking on the fuse base and on the fuse links :

1. Name of the manufacturer
2. Rated current
3. Rated voltage
4. ISI marking and reference of 185 No. (only on fuse links)
5. Rated Power loss
6. Name of the Employer

#### 42. Triple Pole Switch Fuse Units with Neutral Links (200A, 320A & 400A/415 VOLTS RATINGS)

This specification covers manufacture, testing before dispatch and delivery of Triple Pole Switch Fuse Units with neutral Link and HRC cartridge type fuses suitable for AC 3 Phase 4 wire 415 V with neutral solidly grounded system. The working conditions and technical requirements are as under:-

##### TECHNICAL REQUIREMENTS

- a) Rated Current : 200 Amps, 320 Amps & 400 Amps
- b) I) Rated Operational Voltage : 3 Phase 4 Wire, 415 Volts AC 50 Hz  
with solidly earthed neutral
- II) Highest System Voltage : 415V + 10%
- c) Type of Fuse to be used : Non-deteriorating quick arcing type  
ISI marked

HRC Cartridge fuse Links suitable for Class-1 category of duty of IS:13703(Part-I). The temperature rise shall be in accordance with IS:13703 (Part-I) (with latest amendments) over and above the ambient temperature of 45°C. It shall be used for protecting the distribution circuits and distribution transformers and shall be capable of carrying continuously the above stated rated current safely.

- d) Number of Poles : Three
- e) Neutral Link : One
- f) Duty : Un-interrupted duty
- g) Rated fused short circuit current capacity at 415V : 40KA for 1 second. withstands
- h) Utilization category as : AC-23 (B) as defined in IS: 13947 (Pt-III)/ 1993

##### GENERAL

## **1. CONTACTS AND BLADES & OPERATING MECHANISM**

The switch shall be a combination of double break per pole AB switch with HRC fuses in all the three phases. The switch shall be spring assisted, quick make and quick break type having operating mechanism independent of the speed of the operator to minimize the arcing. If required, additional contact springs shall be provided to maintain correct contact pressures throughout operating life of the switches. The switch shall be so constructed that the alignment of its contacts & blades, which will be made of silver plated electrolytic copper/tinned copper, is maintained under asymmetrical fault conditions also. The tenders should furnish in their offers about the details of switching mechanism and the contacts. The switch shall have positive break feature such that it is possible to make it OFF even if the quick action spring fails due to ageing or other causes. The switch fuse unit shall be provided with double break per pole to ensure complete isolation of HRC Fuses from both incoming and outgoing circuits when the switch is in OFF position, in order to minimize the damage to the maintenance personnel. Ample flash over distances shall be provided so as to make the unit suitable for controlling highly inductive loads.

## **2. ENCLOSURES**

The Triple Pole Switch fuse units shall be totally enclosed in robust enclosures made out of 16 gauge/1.5 mm pressed steel sheet (conforming to relevant ISS for M.S. sheet) designed to withstand humid and hot weather conditions. The enclosures should have adequate strength and rigidity to withstand rough usage without fracture or permanent distortion. Suitable mounting arrangement shall be provided on the enclosures for mounting the units on a supporting structure.

## **3. INTER LOCK**

It should not be possible to open the switch cover when the switch is in 'ON' position and also it should not be possible to operate the switch 'ON' when the switch cover is open.

## **4. PAINTING**

The inside and outside of the enclosure should be painted with a grey paint. Before painting the surface, the same should be chemically cleaned for removing rust, grease etc. Then it should be given phosphate coating, followed by two coats of anti-rust primer (i.e. Red zinc Chrome Primer), after which two coats of synthetic paint of light grey colour shall be applied on internal and external surfaces of the enclosures with a spray gun. The enclosures shall then be baked in oven so as to give an elegant and durable finish.

## 5. EARTHING

The enclosure shall be provided with earthing arrangements at two places.

## 6. TERMINAL CONNECTIONS

The switch shall be provided with aluminium lugs for termination of PVC coated aluminium cables of following sizes: -

S.No.	Capacity of TPN Switches	Size of Cable	No. of cable sockets required
1	200 Amps	150 sq.mm. 3.5 Core stranded aluminium cable	8 Nos. (3 Nos. phase leads and 1 natural lead for incoming and also 3 Nos. phase leads and 1 neutral for outgoing connections)
2	320 Amps	300 sq.mm. 3.5 Core stranded aluminium cable	-do-
3	400 Amps	300 sq.mm. 3.5 Core stranded aluminium cable	-do-

7. All the surface contacts (e.g. lugs, connectors, fixed contacts, moving contacts etc.) should be fitted with GI nuts & bolts having yellowish OR whitish passivation with good finish.

## 8. TESTING & TEST CERTIFICATES FOR SWITCHES

The performance of the switch should conform to IS:10027/1981 with latest amendments. Accordingly, certificates from reputed laboratories such as CPRI, ERDA, IITs, for the type tests in accordance with IS:10027/1981 with latest amendment would necessarily be furnished by the tenderers along with offer.

## 9. USE OF ISI MARK HRC FUSES

The HRC Fuses with ISI mark only should be used. These HRC fuses should conform to IS:13703 (Part-I)/1993 or as per its latest revision. The rated current of HRC fuses must be 200 Amps for 200 Amps Switches, 315 Amps for 320 Amps Switches and 400 Amps for 400 Amps Switches.

## 10. IMPORTANT NOTE



The firms must consider supply of 'ISI' certificate (valid on date) products on their offer in the tender, Other certification such as ISO:9001 & 9002 shall be given due weightage while considering their offer, however, the attested photo copies of such certification must be enclosed with the offer.

#### **11. INSULATION FOR LIVE PARTS**

All live parts shall be fully shielded with bakelite shrouds.

### 43. Clamps & Connectors

CLAMPS & CONNECTORS: Clamps & connectors shall conform to IS: 5561. The clamps and connectors shall be made of materials listed below:

For connecting ACSR conductors	Aluminium alloy casting, conforming to designation A6 of IS: 617 and shall be tested for all tests as per IS: 617
For connecting equipment terminals made of copper with ACSR conductor	Bimetallic connectors made from aluminium alloy casting conforming to designation A6 of IS:617 with 2mm thick Bimetallic liner and shall be tested as per IS:617
For connecting GS shield wire	Galvanised mild steel
Bolts, Nuts & plain washers	Hot dip galvanised mild steel for sizes M12 and above, and electro-galvanised for sizes below M12
Spring washers for items 'a' to 'c'	Electro-galvanised mild steel suitable for at least service condition 4 as per IS:1573

All castings shall be free from blow holes, surface blisters, cracks and cavities. All sharp edges and corners shall be blurred and rounded off.

No current carrying part of a clamp or connector shall be less than 10 mm thick. They shall be designed and manufactured to have minimum contact resistance.

For Bimetallic clamps or connectors, copper alloy liner of minimum 2 mm thickness shall be provided.

Flexible connectors, braids or laminated strips made up of copper/ aluminium for the terminal clamps for equipment shall be suitable for both expansion or through (fixed/sliding) type connection of IPS Aluminium tube as required. In both the cases the clamp height (top of the mounting pad to center line of the tube) should be same.

Size of the terminal/conductor for which the clamp/connector is suitable shall be embossed/punched (i.e. indelibly marked) on each components of the clamp/connector, except on the hardware.

Clamp shall be designed to carry the same current as the conductor and the temperature rise shall be equal or less than that of the conductor at the specified ambient temperature. The rated current for which the clamp/ connector is designed with respect to the specified reference ambient temperature, shall also be indelibly marked on each component of the clamp/connector, except on the hardware.

Clamps and connector shall be designed corona controlled.

Clamps & connectors shall conform to type tests and shall be subjected to routine and acceptance tests on minimum 3 samples per lot as per IS: 5561. Type tests report for all clamps and connectors for temperature rise test, tensile test, shall be furnished by the Contractor.

#### 44. Epoxy Based Protective Paint

##### 1. SCOPE

This specification covers the requirement of self-priming epoxy-based protective paint both for new and old steel structures such as poles, sub-station structures etc.

##### 2. COMPOSITION

The paint shall be epoxy-based with metallic zinc as an essential component. The paint shall be supplied in two components and shall be suitable for a single coat application. It shall have such composition as to satisfy the requirements of this standard. The mixing ratio (base-to-accelerator) shall be specified by the manufacturer.

##### 3. REQUIREMENTS

3.1	Volume Solids	85% ( $\pm$ )3%
3.2	Theoretical covering Capacity	6.5 sq. mtrs. per litre at 125 microns dry film thickness
3.3	Weight per 10 litres of mixed paint	14 to 15 Kg. ( $\pm$ ) 0.3 kg
3.4	Drying time (at 30 OC) dry	Surface : Not more than 4 hours Hard Dry : 16-18 hours Recoating Time: 16-18 hours Curing time : 7 days
3.5	Scratch hardness (with 1.5 kg.load)	No such scratch as to show the base metal
3.6	Finish	Smooth and semi-glossy
3.7	Colour	Ash Grey or Aluminium (as required)
3.8	Dry Film Thickness	The paint shall develop a dry film of minimum 100-125 microns in a single coat(measured by Elcometer)
3.9	Flash point	Not below 40 OC
3.10	Flexibility and adhesion	The paint shall not show damage, detachment or cracking.
3.11	Resistance to humidity	Shall pass 1000 hours (minimum) at 125 microns D.F.T
3.12	Resistance to lubricating oil petroleum, hydrocarbon solvent,petrol and heat	Shall show no sign of permanent injury

**4. STORAGE LIFE & POT LIFE**

4.1	Storage life	Minimum 6 months from the date of manufacture in original sealed container under normal covered storage conditions
4.2	Pot life (at 30OC)	Not less than 4 hours

**5. DURABILITY**

Under severe surface conditions, paint shall protect the substrate at least for 5 years, if it is wire-brushed/power tool cleaned and 7 years for commercially grit-blasted steel sub-strate.

**6. SURFACE PREPARATION**

If possible, the surface on which the paint has to be applied shall be cleaned by grit blasting, otherwise manual wire brushing or power tool cleaning process may be used as convenient.

**7. METHOD OF APPLICATION**

Brushing, rollers or spraying.

**8. TESTS**

The following tests shall be carried out in accordance with the procedure given in the Indian Standard quoted against each, except requirements stipulated in clauses 3.1 and 3.2 which shall be tested in accordance with the procedure indicated in Annexure-II; preparation of painted panels for conducting different tests shall be done as given in Annexure-I.

**8.1** Requirement stipulated in clauses 3.3 to 3.12 - **IS:101**

**8.2 Resistance to Salt Spray**

Shall pass 1000 hours (minimum with 200 microns D.F.T.) - **IS:2074**

**8.3 Chemical Resistance**

Shall be resistant to acid/alkaline chemicals or solvents - **IS:8662**

**9. PACKAGE**

Unless otherwise specified by the purchaser, the paint shall be normally supplied in 2 litre packs.

**Annexure – I**

**DETAILS OF PREPARATION OF PAINTED PANELS FOR TESTING EPOXY BASED**

**PROTECTIVE PAINT ( TWO PACKS)**

S. N .	Test	Type of Metal	Size in mm	Painting Details	Dry Film Thickness	Method of Application	Duration of air drying before commencement of test	Special Instructions
1	2	3	4	5	6	7	8	9
1	Drying Time	Mild Steel	150x100x1.25	One coat of Epoxy based protective paint	100	Brush /Spray	-	-
2	Finish		-do-		-do -	-do -	48 hours	
3	Colour	-do -	-do -	-do -	-do-	-do -	24 hours	-
4	Dry Film Thickness	-do -	-do -	-do -	-do -	-do -	24 hours	-
5	Flexibility and adhesion	-do -	150x150x0.315	-do-	-do-	-do-	7 days	-
6	Scratch Hardness	Tinned	-do -	-do -	-do -	-do -	-do -	-
7	Resistance to Salt Spray	-do -	150x150x1.25	-do-	200	-do -	7 days	Apply a load of 1.5 Kgs. Instead of 1 kg.

8	Protection against corrosion under conditions of condensation	Mild Steel  - do - -	- do -	-do-	125	- do -	- do -	As specified in Col.15.1 of IS: 101 - 64 -
---	---	-------------------------------	--------	------	-----	--------	--------	--

## ANNEXURE-II

### Procedure for determining volume solids

#### 1. Scope :

This method is applicable to the determination of the volume non-volatile matter of paint coatings.

#### 2. Significance :

This method is intended to provide a measure of the volume of dry coating obtainable from a given volume of liquid coating. This volume is considered to be the most equitable means of comparing the coverage (square metre of surface covered at a specific film thickness per unit volume) and also for calculating the wet film thickness of the given paint.

#### 3. Apparatus

- i) Analytical Balance
- ii) Steel disc : Preferably stainless steel, 60mm dia, and 0.70mm thickness with a small hole 2 to 3mm from the edge. A fine wire such as chromel is attached through the hole and made of the appropriate length for suspending the disc in a liquid.
- iii) Weight Box
- iv) Beaker : 1 litre for weighing the disc in liquid.
- v) Weight per litre cup for determining the specific gravity of the paint material and of the suspending liquid if not known.
- vi) Oven

#### 4. Procedure

- i) Dry the disk in an oven at 105<sup>0C</sup> for 10 minutes and cool.
- ii) Weigh the disk in air, let it be W1 grams.
- iii) Suspend the disk in water and weigh again. Let it be W2 grams.

iv) Calculate the volume of disk 'V' as follows:

$V = W1 - W2/d$  where 'd' is the density of the water at room temperature

v) Determine the weight of non-volatile content per gram of the liquid coating material by drying a known amount of paint at 105<sup>0</sup>C for 3 hours. Let it be 'W' grams.

vi) Determine the specific gravity of the paint to the nearest 0.001 g/ml. by using weight per liter cup. Let it be 'p'.

vii) Dip the disk in the paint sample for 10 minutes, and take out the disc and allow the excess coating material to drain off. Blot the coating material off the bottom edge of the disc so that beads or drops do not dry on the bottom edge of the disc.

viii) Dry the disc in oven for 3 hours at 105<sup>0</sup> C and cool.

ix) Weigh the coated disc in air. Let it be W3 grams.

x) Suspend the coated disc in water and weigh it. Let it be W4 grams.

xi) Calculate the volume of the coated disc as follows:

$V1 = W3 - W4/d$ , where 'd' is the density of the water at room temperature.

xii) Calculate the volume of the dried coating as follows:

Volume of dried coating (Vd) =  $V1 - V$

xiii) Calculate the volume of the wet coating as follows:

$V_w = W3 - W1/W \times P$ , where W = grams of non volatile matter in one gram of wet coating

P = Specific gravity of the paint.

xiv) Calculate the percentage volume solids of the paints as follows:

$$= \frac{V1 - V \times 100}{V_w} \quad \text{or} \quad \frac{V_d \times 100}{V_w}$$

The volume of non volatile matter or the percentage volume solids of a paint is related to the covering capacity and film thickness in the following manner:

- a) Theoretical Coverage ( $m^2/l$ ) =  $\frac{\% \text{ volume solids} \times 10}{\text{Dry film thickness (in microns)}}$
- b) Wet film thickness (in microns) =  $\frac{\text{Dry Film thickness} \times 100}{\text{(in microns)}}$

% volume solids.





## **45. Mid Span Compression Joint and Repair Sleeve**

### **1.0 Mid Span Compression Joint**

**1.1** Mid Span Compression Joint shall be used for joining two lengths of conductor. The joint shall have a resistivity less than 75% of the resistivity of equivalent length of conductor. The joint shall not permit slipping off, damage to or failure of the complete conductor or any part thereof at a load less than 95% of the ultimate tensile strength of the conductor.

**1.2** In ACSR conductors, the joint shall be made of steel and Aluminium for jointing the steel core and Aluminium respectively. The steel sleeve should not crack or fail during compression. The Brinell Hardness of steel sleeve shall not exceed 200. The steel sleeve shall be hot dip galvanised. The Aluminium shall have Aluminium/alloy. Aluminium plugs shall also be provided on the line of demarcation between compression and non compression zone.

### **2.0 Repair Sleeve**

Repair Sleeve of compression type shall be used to repair conductor with not more than two strands broken in the outer layer. The sleeve shall be manufactured from Aluminium and shall have a smooth surface. The repair sleeve shall comprise of two pieces with a provision of seat for sliding of the keeper piece. The edges of the seat as well as the keeper piece shall be so rounded that the conductor strands are not damaged during **installation**.

### **3.0 Material and Workmanship**

**3.1** All the equipment shall be of the latest proven design and conform to the best modern practices adopted in the power line field. The Supplier shall offer only such equipment as guaranteed by him to be satisfactory and suitable for 11/33 kV transmission line application and will give continued good performance.

**3.2** The design, manufacturing process and quality control of all the materials shall be such as to achieve requisite factor of safety for maximum working load, highest mobility, elimination of sharp edges and corners, best resistance to corrosion and a good finish.

**3.3** All ferrous parts shall be hot dip galvanised, after all machining has been completed. Nuts may, however, be tapped (threaded) after galvanising and the threads oiled. Spring washers shall be electro galvanized as per grade 4 of IS-1573-1970. The bolt threads shall be undercut to take care of increase in diameter due to galvanising. Galvanising shall be done in accordance with IS:2629-1985 / IS-1367 (Part-13) and satisfy the tests mentioned in IS-2633-1986. Fasteners shall withstand four dips while spring washers shall withstand three dips. Other galvanised materials shall have a minimum over range coating of Zinc equivalent to 600 gm/sq.m and shall be guaranteed to withstand at least six dips each lasting one minute under the standard Peerce test for galvanising unless otherwise specified.

- 3.4** The zinc coating shall be perfectly adherent, of uniform thickness, smooth, reasonably bright, continuous and free from imperfections such as flux, ash, rust stains, bulky white deposits and blisters. The zinc used for galvanising shall be of grade Zn.99.95 as per IS:209.
- 3.5** In case of castings, the same shall be free from all internal defects like shrinkage, inclusion, blow holes. cracks etc.
- 3.6** All current carrying parts shall be so designed and manufactured that contact resistance is reduced to minimum and localised heating phenomenon is averted.
- 3.7** No equipment shall have sharp ends or edges, abrasions or projections and shall not cause any damage to the conductor in any way during erection or during continuous operation which would produce high electrical and mechanical stresses in normal working. The design of adjacent metal parts and mating surfaces shall be such as to prevent corrosion of the contact surface and to maintain good electrical contact under all service conditions.
- 3.8** Particular care shall be taken during manufacture and subsequent handling to ensure smooth surface free from abrasion or cuts.
- 3.9** The fasteners shall conform to the requirements of IS:6639-1972. All fasteners and clamps shall have corona free locking arrangement to guard against vibration loosening.

#### **4.0 Compression Markings**

Die compression areas shall be clearly marked on each equipment designed for continuous die compressions and shall bear the words 'COMPRESS FIRST' suitably inscribed on each equipment where the compression begins. If the equipment is designed for intermittent die compressions, it shall bear the identification marks 'COMPRESSION ZONE' and 'NON-COMPRESSION ZONE' distinctly with arrow marks showing the direction of compression and knurling marks showing the end of the zones. The letters, number and other markings on finished equipment shall be distinct and legible.

#### **5.0 Drawings**

- 5.1** The Supplier shall furnish detailed dimensioned drawings of the equipments and all component parts. Each drawing shall be identified by a drawing number and Contract number. All drawings shall be neatly arranged. All drafting and lettering shall be legible. The minimum size of lettering shall be 3 mm. All dimensions and dimensional tolerances shall be mentioned in mm.
- 5.2** The drawings shall include
- (i) Dimensions and dimensional tolerances
  - (ii) Material. Fabrication details including any weld details and any specified finishes and coatings. Regarding material, designations and reference of standards are to be indicated.

- (iii) Catalogue No.
- (iv) Marking
- (v) Weight of assembly
- (vi) Installation instructions
- (vii) Design installation torque for the bolt or cap screw
- (viii) Withstand torque that may be applied to the bolt or cap screw without failure of component parts
- (ix) The compression die number with recommended compression pressure.
- (x) All other relevant technical details

**5.3** The above drawings shall be submitted in 3 copies with all the details as stated above along with the bid document. After the placement of award. The Contractor shall again submit the drawings in four copies to the Owner for approval. After Owner's approval and successful completion of all type tests, 10 more sets of drawings shall be submitted to Owner for further distribution and field use at Owner's end.

## **6.0 Tests**

### **6.1 Type Tests**

#### **6.1.1 Mid Span Compression Joint for Conductor**

- (a) Chemical analysis of materials ( as per Annexure – A)
- (b) Electrical resistance test
- (c) Heating cycle test
- (d) Slip strength test

#### **6.1.2 Repair Sleeve for Conductor**

- (a) Chemical analysis of materials

#### **6.1.3 Flexible Copper Bond**

- (a) Slip Strength Test ( as per Annexure – A)

### **6.2 Acceptance Tests**

#### **6.2.1 Mid Span Compression Joint for Conductor and Earthwire**

- (a) Visual examination and dimensional verification
- (b) Galvanising test
- (c) Hardness test

#### **6.2.2 Repair Sleeve for Conductor**

- (a) Visual examination and dimensional verification

### 6.2.3 Flexible Copper Bond

- (a) Visual examination and dimensional verification
- (b) Slip strength test

### 6.3 Routine Tests

- (a) Visual examination and dimensional verification

### 6.4 Tests During Manufacture

On all components as applicable

- (a) Chemical analysis of Zinc used for galvanising ) )
- (b) Chemical analysis mechanical metallographic test and magnetic particle inspection for malleable castings ) As per Annexure-A )
- (c) Chemical analysis, hardness tests and magnetic particle inspection for forgings ) )

## 7.0 Tests and Standards

### 7.1 Testing Expenses

**7.1.1** Supplier shall indicate the laboratories in which they proposes to conduct the type tests. They shall ensure that adequate facilities for conducting the tests are available in the laboratory and the tests can be completed in these laboratories within the time schedule guaranteed by them in the appropriate schedule.

**7.1.2** The Contractor shall intimate the Owner about carrying out of the type tests alongwith detailed testing programme at least 3 weeks in advance of the scheduled date of testing during which the Owner will arrange to depute his representative to be present at the time of carrying out the tests.

### 8.0 Sample Batch For Type Testing

**8.1** The Contractor shall offer material for sample selection for type testing only after getting Quality Assurance Programme approved by the Owner. The Contractor shall offer at least three times the quantity of materials required for conducting all the type tests for sample selection. The sample for type testing will be manufactured strictly in accordance with the Quality Assurance Programme approved by the Owner.

**8.2** Before sample selection for type testing the Contractor shall be required to conduct all the acceptance tests successfully in presence of Owner's representative.

## **9.0 Schedule of Testing and Additional Tests**

**9.1** The Supplier has to indicate the schedule of following activities

- (a) Submission of drawing for approval.
- (b) Submission of Quality Assurance programme for approval.
- (c) Offering of material for sample selection for type tests.
- (d) Type testing.

**9.2** The Owner reserves the right of having at his own expense any other test(s) of reasonable nature carried out at Contractor's premises, at site, or in any other place in addition to the aforesaid type, acceptance and routine tests to satisfy himself that the material comply with the specifications.

**9.3** The Owner also reserves the right to conduct all the tests mentioned in this specification at his own expense on the samples drawn from the site at Contractor's premises or at any other test centre. In case of evidence of non compliance, it shall be binding on the part of Contractor to prove the compliance of the items to the technical specifications by repeat tests, or correction of deficiencies, or replacement of defective items, all without any extra cost to the Owner.

## **10 Test Reports**

**10.1** Copies of type test reports shall be furnished in atleast six copies alongwith one original. One copy shall be returned duly certified by the Owner, only after which the commercial production of the concerned material shall start.

**10.2** Copies of acceptance test report shall be furnished in atleast six copies. One copy shall be returned, duly certified by the Owner, only after which the materials will be despatched.

**10.3** Record of routine test report shall be maintained by the Contractor at his works for periodic inspection by the Owner's representative.

**10.4** Test certificates of tests during manufacture shall be maintained by the Contractor. These shall be produced for verification as and when desired by the Owner.

## **11.0 Inspection**

**11.1** The Owner's representative shall at all times be entitled to have access to the works and all places of manufacture, where the material and/or its component parts shall be manufactured and the representatives shall have full facilities for unrestricted inspection of the Contractor's, sub-Contractor's works raw materials. manufacturer's of all the material and for conducting necessary tests as detailed herein.

- 11.2** The material for final inspection shall be offered by the Contractor only under packed condition. The engineer shall select samples at random from the packed lot for carrying out acceptance tests.
- 11.3** The Contractor shall keep the Owner informed in advance of the time of starting and of the progress of manufacture of material in its various stages so that arrangements could be made for inspection.
- 11.4** Material shall not be despatched from its point of manufacture before it has been satisfactorily inspected and tested unless the inspection is waived off by the Owner in writing. In the latter case also the material shall be despatched only after all tests specified herein have been satisfactorily completed.
- 11.5** The acceptance of any quantity of material shall in no way relieve the Contractor of his responsibility for meeting all the requirements of the Specification, and shall not prevent subsequent rejection, if such material are later found to be defective.

## **12.0 Packing and Marking**

- 12.1** All material shall be packed in strong and weather resistant wooden cases/crates. The gross weight of the packing shall not normally exceed 50 Kg to avoid handling problems.
- 12.2** The packing shall be of sufficient strength to withstand rough handling during transit, storage at site and subsequent handling in the field.
- 12.3** Suitable cushioning, protective padding, dunnage or spacers shall be provided to prevent damage or deformation during transit and handling.
- 12.4** Bolts, nuts, washers, cotter pins, security clips and split pins etc. shall be packed duly installed and assembled with the respective parts and suitable measures shall be used to prevent their loss.
- 12.5** Each component part shall be legibly and indelibly marked with trade mark of the manufacturer and year of manufacture.
- 12.6** All the packing cases shall be marked legibly and correctly so as to ensure safe arrival at their destination and to avoid the possibility of goods being lost or wrongly despatched on account of faulty packing and faulty or illegible markings. Each wooden case/crate shall have all the markings stencilled on it in indelible ink.

## **13.0 Standards**

- 13.1** The Hardware fittings, conductor and earthwire accessories shall conform Indian/International Standards which shall mean latest revisions, with amendments/changes adopted and published, unless specifically stated otherwise in the Specification.

## **ANNEXURE – A**

### **1.0 TESTS ON HARDWARE FITTINGS**

#### **1.1 Galvanising/Electroplating Test**

The test shall be carried out as per Clause no. 5.9 of IS:2486-(Part-1) - 1972 except that both uniformity of zinc coating and standard preece test shall be carried out and the results obtained shall satisfy the requirements of this specification.

#### **1.2 Mechanical Strength Test of Each Component**

Each component shall be subjected to a load equal to the specified minimum ultimate tensile strength (UTS) which shall be increased at a steady rate to 67% of the minimum UTS specified. The load shall be held for five minutes and then removed. The component shall then again be loaded to 50% of UTS and the load shall be further increased at a steady rate till the specified UTS and held for one minute. No fracture should occur. The applied load shall then be increased until the failing load is reached and the value recorded.

#### **1.3 Mechanical Strength Test of Welded Joint**

The welded portion of the component shall be subjected to a Load of 2000 kgs for one minute. Thereafter, it shall be subjected to die-penetration/ ultrasonic test. There shall not be any crack at the welded portion.

#### **1.4 Clamp Slip Strength Vs Torque Test for Suspension Clamp**

The suspension assembly shall be vertically suspended by means of a flexible attachment. A suitable length of Conductor shall be fixed in the clamp. The clamp slip strength at various tightening torques shall be obtained by gradually applying the load at one end of the conductor. The Clamp slip strength vs torque curve shall be drawn. The clamp slip strength at the recommended tightening torque shall be more than 12.5% but less than 20% of conductor rated strength.

### **2.0 TESTS ON CONDUCTOR AND EARTHWIRE ACCESSORIES**

#### **2.1 Mid Span Compression Joint for Conductor and Earthwire**

##### **(a) Slip Strength Test**

The fitting compressed on conductor/earthwire shall not be less than one metre in length. The test shall be carried out as per IS:2121 (Part-II)- clause 6.4 except that the load shall be steadily increased to 95% of minimum ultimate tensile strength of conductor/earthwire and retained for one minute at this load. There shall be no

movement of the conductor/ earthwire relative to the fittings and no failure of the fittings during this one minute period.

**(b) Hardness Test**

The Brinnel hardness at various points on the steel sleeve of conductor core and of the earthwire compression joint and tension clamp shall be measured.

**2.2 Flexible Copper Bond**

**a) Slip Strength Test**

On applying a load of 3 kN between the two ends, stranded flexible copper cable shall not come out of the connecting lugs and none of its strands shall be damaged. After the test, the lugs shall be cut open to ascertain that the gripping of cable has not been affected.

**2.3 Chemical Analysis Test**

Chemical analysis of the material used for manufacture of items shall be conducted to check the conformity of the same with Technical Specification and approved drawing.

**3.0 TESTS ON ALL COMPONENTS (AS APPLICABLE)**

**3.1 Chemical Analysis of Zinc used for Galvanizing**

Samples taken from the zinc ingot shall be chemically analysed as per IS-209. The purity of zinc shall not be less than 99.95%.

**3.2 Tests for Forgings**

The chemical analysis hardness tests and magnetic particle inspection for forgings, will be as per the internationally recognised procedures for these tests. The, sampling will be based on heat number and heat treatment batch. The details regarding test will be as discussed and mutually agreed to by the Contractor and Owner in Quality Assurance Programme.

**3.3 Tests on Castings**

The chemical analysis, mechanical and metallographic tests and magnetic particle inspection for castings will be as per the internationally recognised procedures for these tests. The samplings will be based on heat number and heat treatment batch. The details regarding test will be as discussed and mutually agreed to by the Contractor and Owner in Quality Assurance Pro



#### 46. Terminal Block

All internal wiring to be connected to the external equipment shall terminate on terminal blocks, preferably vertically mounted on the side of cabinet, junction box, terminal box and marshalling box.

The terminal blocks shall be made of moulded, non-inflammable thermosetting plastic. The material of terminal block moulding shall not deteriorate because of varied conditions of heat, cold humidity, dryness etc. that would be anticipated at the location where the equipment is proposed to be installed.

The terminal shall be such that maximum contact area is achieved when a cable is terminated. The terminal shall have a locking characteristic to prevent cable from escaping from the terminal clamp unless it is done intentionally. The terminal blocks shall be non-disconnecting stud type equivalent to Elmex type CAT-M4.

The conducting part in contact with cable shall be tinned or silver plated. The terminal blocks shall be of extensible design. The terminal blocks shall be of 1100 V grade and shall be rated to carry continuously the maximum current that is expected to be carried by the terminals.

The terminal blocks shall be fully enclosed with removable covers of transparent, non-deterioration type plastic material. Insulating barriers shall be provided between the terminal blocks. These barriers shall not hinder the operator from carrying out the wiring without removing the barriers.

The terminals shall be provided with the marking tags for wiring identification.

The blocks shall be provided with 20% spare terminals unless otherwise specified. Unless otherwise specified, terminal blocks shall be suitable for connecting the following conductors on each side.

All circuits except CT/VT      Minimum of two 2.5 sq.mm copper flexible

All CT/VT circuits      Minimum of 4 nos. of 2.5 sq.mm copper flexible

AC/DC Power supply circuit      One of 16 sq. mm. Aluminium.

There shall be a minimum clearance of 250 mm between the first row of terminal block and the cable gland plate or side of the box. Also the clearance between two rows of terminal blocks shall be a minimum of 150 mm.

The arrangements shall be in such a manner so that it is possible to safely connect or disconnect terminals on live circuits and replace fuse links when the cabinet is live. Cabinet wiring should be suitable for 60°C as the space heaters will keep the temperature 10°C higher than the ambient.

For the Control and Relay Panels the terminal blocks for current transformer and voltage transformer secondary lead shall be provided with test links and isolating facilities. Also current transformer secondary leads shall be provided with short circuiting and earthing facilities.

## 47. Wiring

All wiring shall be carried out with 1100 V grade stranded copper wires. The minimum size of the stranded conductor used for internal wiring shall be as follows:

1. All circuits except CT circuits 2.5 sq.mm
2. CT circuits 2.5 sq. mm (minimum number of strands shall be 3 per conductor).

All internal wiring shall be securely supported, neatly arranged readily accessible and connected to equipment terminals and terminal blocks.

Wire terminations shall be made with solderless crimping type of tinned copper lugs which firmly grip the conductor and insulation. Insulated sleeves shall be provided at all the wire terminations. Engraved core identification plastic ferrules marked to correspond with the wiring diagram shall be fitted at both ends of each wire. Ferrules shall fit tightly on the wires shall not fall off when the wires and shall not fall off when the wire is disconnected from terminal blocks.

All wires directly connected to trip circuit breaker shall be distinguished by the addition of a red coloured unlettered ferrule. Number 6 & 9 shall not be included for ferrules purposes.

All terminals including spare terminals of auxiliary equipment shall be wired upto terminal blocks. Each equipment shall have its own central control cabinet in which all contacts including spare contacts from all poles shall be wired out. Inter-pole cabling for all equipment's shall be carried out by the Contractor.

#### **48. Equipment Erection Notes**

All support insulators, circuit breaker and other fragile equipment shall preferably be handled with cranes with suitable booms and handling capacity.

The slings shall be of sufficient length to avoid any damage to insulator due to excessive swing, scratching by sling ropes etc.

For cleaning the inside and outside of Hollow insulators only muslin or leather cloth shall be used.

Handling equipment, sling ropes etc. should be tested before erection and periodically for strength.

Bending of compressed air piping should be done by a bending machine and through cold bending only. Bending shall be such that inner diameter of pipe is not reduced.

Cutting of the pipes wherever required shall be such as to avoid flaring of the ends, and only a proper pipe cutting tool shall be used. Hack-saw shall not be used.

The Contractor shall arrange at site all the equipments, instruments and auxiliaries required for testing and commissioning of equipment.

##### **STORAGE OF EQUIPMENTS**

The Contractor shall provide and construct adequate storage shed for proper storage of equipments. Weather sensitive equipment shall be stored indoor. All equipments during storage shall be protected against damage due to acts of nature or accidents. The storage instruction of the equipment manufacturer/Owner shall be strictly adhered to.

## **49. Danger Notice Plates**

### **1. SCOPE**

This Specification covers Danger Notice Plates to be displayed in accordance with rule No. 35 of Indian Electricity Rules, 2003.

### **2. APPLICABLE STANDARDS**

Unless otherwise modified in this specification, the Danger Notice Plates shall comply with IS:2551-1982 or the latest version thereof.

### **3. DIMENSIONS**

#### **3.1** Two sizes of Danger Notice Plates as follows are recommended:

- a) For display at 415 V installations - 200x150mm
- b) For display at 11 KV (or higher voltages) installations - 250x200mm

#### **3.2** The corners of the plate shall be rounded off.

#### **3.3** The location of fixing holes as shown in Figs. 1 to 4 is provisional and can be modified to suit the requirements of the purchaser.

### **4. LETTERINGS**

All letterings shall be centrally spaced. The dimensions of the letters, figures and their respective position shall be as shown in figs. 1 to 4. The size of letters in the words in each language and spacing between them shall be so chosen that these are uniformly written in the space earmarked for them.

### **5. LANGUAGES**

#### **5.1** Under Rule No. 35 of Indian Electricity Rules, 2003, the owner of every medium, high and extra high voltage installation is required to affix permanently in a conspicuous position a danger notice in Hindi or English and, in addition, in the local language, with the sign of skull and bones.

#### **5.2** The type and size of lettering to be done in Hindi is indicated in the specimen danger notice plates shown in Fig. 2 and 4 and those in English are shown in Figs. 1 and 3.

#### **5.3** Adequate space has been provided in the specimen danger notice plates for having the letterings in local language for the equivalent of 'Danger', '415' '11000' and 'Volts'.

**6. MATERIAL AND FINISH**

The plate shall be made from mild steel sheet of at least 1.6mm thick and vitreous enameled white, with letters, figures and the conventional skull and cross-bones in signal red colour (refer IS:5-1978) on the front side. The rear side of the plate shall also be enamelled.

**7. TESTS**

The following tests shall be carried out :

- i) Visual examination as per IS:2551-1982
- ii) Dimensional check as per IS:2551-1982
- iii) Test for weather proofness as per IS:8709-1977 (or its latest version)

**8. MARKING**

Maker's name and trade mark and the purchaser's name shall be marked in such a manner and position on the plates that it does not interfere with the other information.

**9. PACKING**

The plates shall be packed in wooden crates suitable for rough handling and acceptable for rail/road transport.

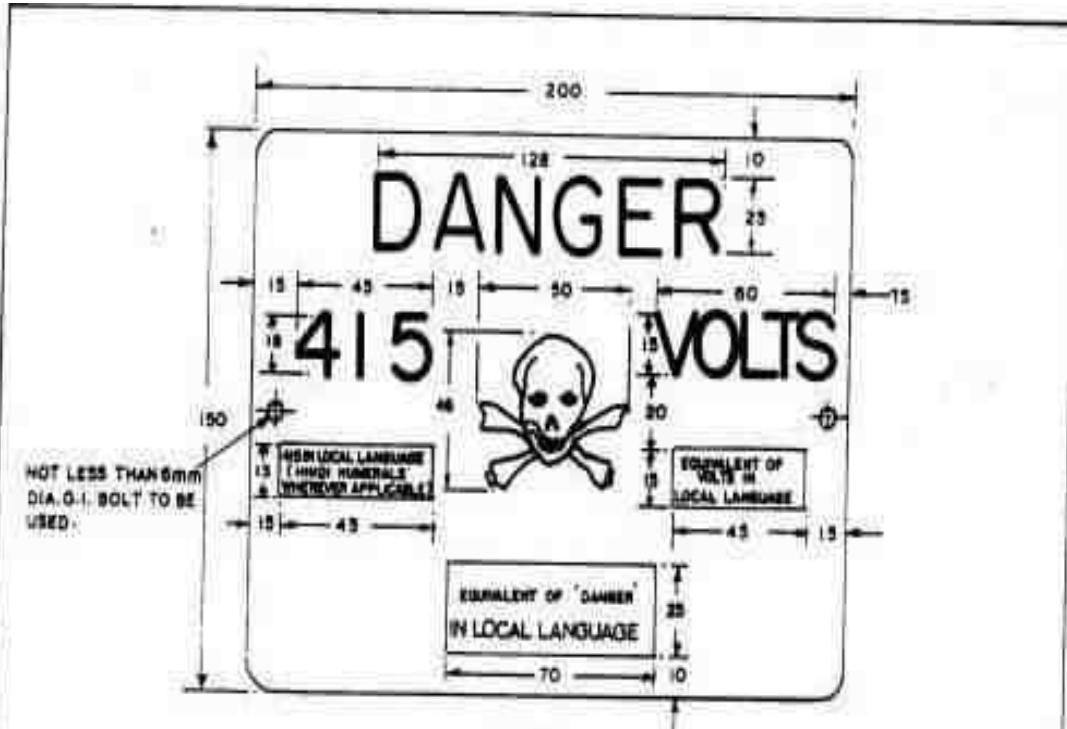

FIG. - 1

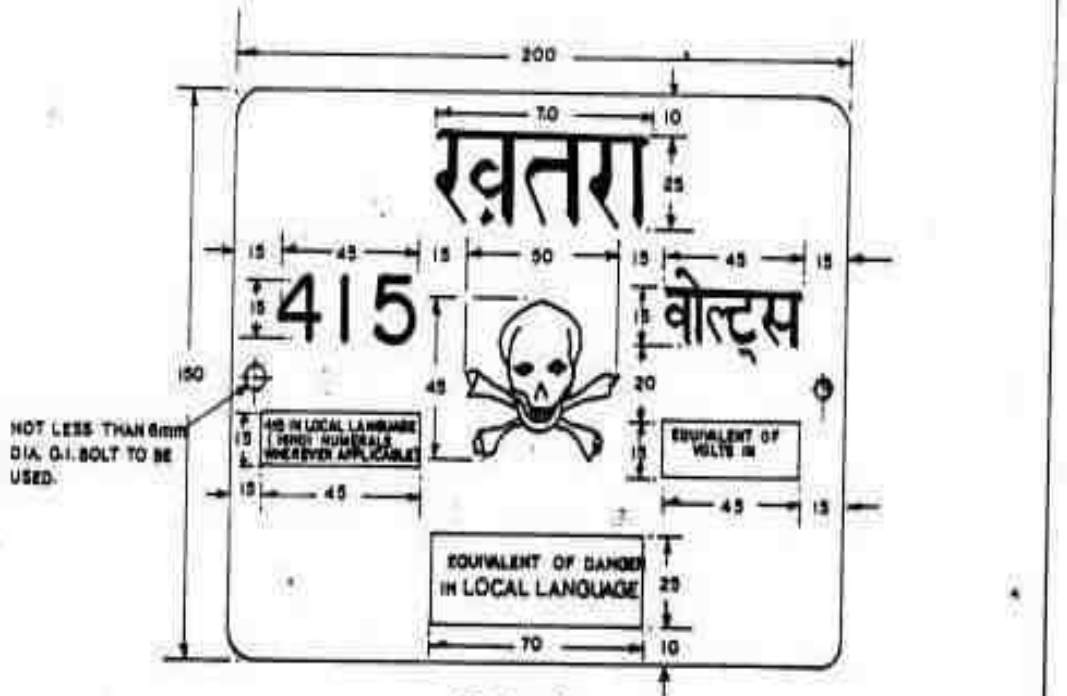

FIG. - 2

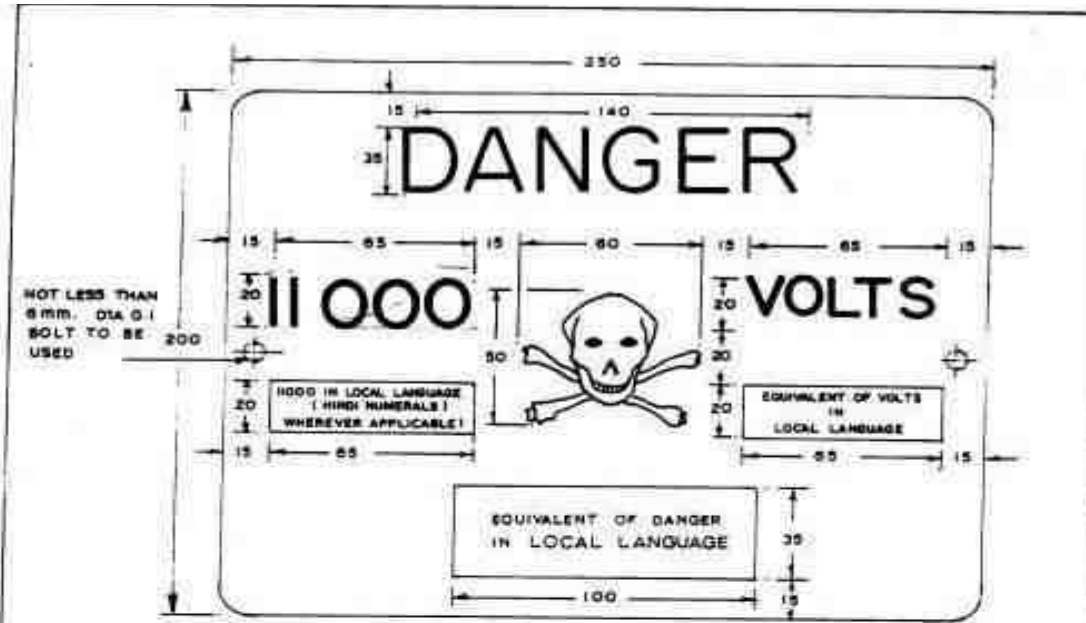

FIG:-3

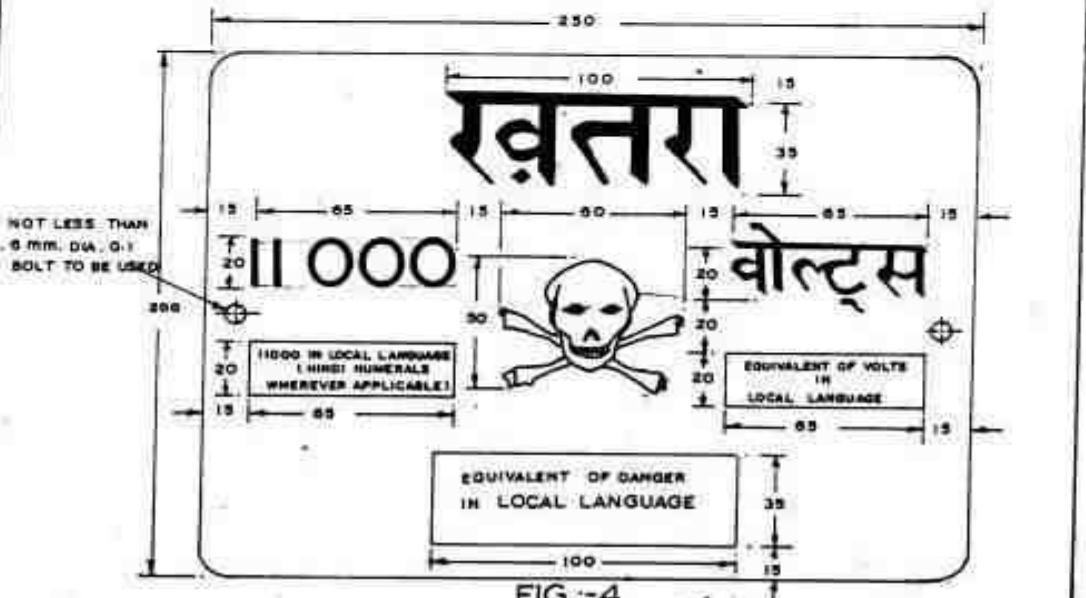

FIG:-4

NOTE: 1000 SHALL BE REPLACED BY 33000, 55000 ETC., AS REQUIRED.

ALL DIMENSIONS ARE IN MM.

## 50. Number Plate (Support)

Weather proof number plate shall have unique name are to be installed on the pole support. The plate shall be made from mild steel sheet of at least 1.6mm thick and vitreous enameled white, with letters in signal red color (refer IS: 5-1978) on the front side. The rear side of the plate shall also be enameled. The digits shall be as under:

**110121**

**000001**

**226**

Digits shall be displayed as detailed above having at-least 25mm height. The over all size of the plate shall be 200x250mmx1.6mm. The corners of the plate shall be rounded off. All lettering shall be centrally spaced. The dimensions of the letters, figures and their respective position shall be as shown above. The size of digits and spacing between them shall be so chosen that these are uniformly written in the space earmarked for them. The type and size of digits to be written in English as indicated above. The plate should be provided with 6mm dia holes in horizontal alignment for fixing to the pole by means of Galvanized MS flat clamp of 25x3 mm size. The nut & bolts used for fixing of plate should be of galvanized and washers of electro-plated. The bolt should be used of at-least 6mm diameter.

TESTS: The following tests shall be carried out:

- i) Visual examination as per IS:2551-1982
- ii) Dimensional check as per IS:2551-1982
- iii) Test for weather proof-ness as per IS 8709-1977 (or its latest version).

### **Numbering Transformer/ Feeders/ Equipments ( in Grid Sub-Station ):**

All augmented/ new power transformer, Breakers, Outgoing feeders, respective control panels, Kiosks are to be named. Base should be painted with yellow paint and black digits should be displayed of at-least 25mm height. Experienced painter should be used to provide this work. LT and HT bushing should be colour coded, CT and PT panels are to be named. The Yellow base plate should be encircled by a black strip. Naming shall be in the local as well as English language.

### **Numbering of control panel:**

Name of Feeder should be displayed on front end and at rear end along with serial number of the panel. Yellow base paint and 25mm high black digits are to be used for this purpose. The base paint should be encircled by a black strip. Naming shall be in the local as well as English language.



Strip  
25mm Height



## **51. Cable Glands and Lugs**

Cable glands shall be Double compression type, tinned/Nickel plated (coating thickness not less than 20 microns in case of tin and 10 to 15 microns in case of nickel) brass cable glands for all power and control cables. They shall provide dust and weather proof terminations. They shall comprise of heavy duty brass casting, machine finished and tinned to avoid corrosion and oxidation. Rubber components used in cable glands shall be neoprene and of tested quality. Required number of packing glands to close unused openings in gland plates shall also be provided.

The cable glands shall be tested as per BS: 6121. The cable glands shall also be duly tested for dust proof and weather proof termination.

Cables lugs shall be tinned copper solder less crimping type conforming to IS: 8309 and 8394 suitable for aluminum or copper conductor (as applicable). The cable lugs shall suit the type of terminals provided. The cable lugs shall be of Dowell make or equivalent.

## 52. Cables Tags and Markers

Each cable and conduit run shall be tagged with numbers that appear in the cables and conduit schedule.

The tag shall be of aluminum with the number punched on it and securely attached to the cable conduit by not less than two turns of 20 SWG GI wire conforming to IS: 280. Cable tags shall be of rectangular shape for power cables and of circular shape for control cables.

Location of cables laid directly underground shall be clearly indicated with cable marker made of galvanized iron plate.

Location of underground cable joints shall be indicated with cable marker with an additional inscription "Cable Joint".

The marker shall project 150 mm above ground and shall be spaced at analysis interval 30 meters and at every change in direction. They shall also be located on both sides of road and drain crossings.

Cable tags shall be provided on all cables at each end (just before entering the equipment enclosure), on both sides of a wall or floor crossing and on each duct/conduit entry. Cable tags shall be provided inside the switchgear, motor control centers, control and relay panels, etc., wherever required for cable identification, such as where a number of cables enter together through a gland plate.

The price of cable tags and markers shall be included in the installation rates for cables/ conduits quoted by the contractor.

Specific requirements for cabling for cabling, wiring, ferrules as covered in respective equipment section shall also be complied with.

### **CABLE GLANDS**

Double compression type cable glands shall be provided by the Contractor for all power and control cables to provide dust and weather proof termination. Required number of packing glands to close unused openings in gland plates shall also be provided.

### **CABLE LUGS**

Solderless crimping of terminals shall be done by using corrosion inhibitory compound. The cable lugs shall suit the type of terminals provided. Crimping tool used shall be of approved design and make.

Storage and handling of cable drums

Cable drums shall be unloaded, handled and stored in an approved manner. Rolling of drums shall be avoided as far as practicable. For short distances, the drums may be rolled provided they are rolled slowly and in proper direction as marked on the drum. In absence of any indication the drums may be rolled in the same direction it was rolled during taking up the cables.

### **CABLE SUPPORTS AND CABLE TRAY MOUNTING ARRANGEMENTS**

Cable trenches in the control room are normally provided with embedded steel inserts on concrete floors/ walls. The Contractor shall secure supports by welding to these inserts or available building steel structures.

Insert plates will be provided at an interval of 600 mm wherever cables are to be supported without the use of cable trays, while at all other places these will be at an interval of 2000 mm.

### **CABLE TERMINATIONS AND CONNECTIONS**

The termination and connection of cables shall be done strictly in accordance with cable and termination kit manufacturer's instructions, drawing and/ or as directed by the Owner.

The work shall include all clamping, fittings, fixing, plumbing, soldering, drilling, cutting, taping, heat shrinking (where applicable), connecting to cable terminal, shorting and grounding as required to complete the job.

The equipment will be generally provided with un-drilled gland plates for cables/conduit entry. The Contractor shall be responsible for drilling of gland plates, painting, and touching up. Holes shall not be made by gas cutting.

The Contractor shall tag/ferrule the control cable cores at all terminations, as instructed by the Owner. In panels where a large number of cables are to be terminated and cable identification may be difficult, each core ferrule may include the complete cable number as well. Spare cores shall be similarly tagged with cable numbers and coiled up.

Control cables shall have stranded copper conductor. Bare portion of the solid conductors shall be tinned after removing the insulation and shall be terminated directly without using cable lugs.

All cable entry points shall be sealed and made vermin and dust proof. Unused openings shall be effectively closed.

If the cable-end box or terminal enclosure provided on the equipment is found unsuitable and requires modification, the same shall be carried out by the Contractor with the approval of the Owner.

### **DIRECTLY BURIED CABLES**

The Contractor shall construct the cable trenches required for directly buried cables. The scope of work and unit rates for construction of cable trenches for cables shall include excavation, preparation of sand bedding, soil cover, supply and installation of brick or concrete protective cover, back filling and reaming, supply and installation of route markers and joint markers. The Contractor/Supplier shall ascertain the soil conditions prevailing at site, before quoting the unit rates. Laying the cable and providing protective covering shall be as per approved drawing.

#### **Installation of cables**

Power and control cables shall be laid in separate tiers. The order of laying of various cables shall be as follows:

- Power cables on top tiers.
- Control, instrumentation and other service cables in bottom tiers.

Single core cable in trefoil formation shall be laid with a distance of three times the diameter of cables between trefoil center lines. All power cables shall be laid with a minimum center to center distance equal to twice the diameter of the cable.

Power and control cables shall be securely fixed to the trays/ supports. Trefoil clamps for single core cables shall be pressure die-cast aluminum (LM-6). Nylon-6 or fiber glass and shall include necessary fixing nuts, bolts, washer, etc. These are required at every 2 meter of cable run. Vertical and inclined cable runs shall be secured with 25 mm wide and 2 mm thick aluminum strip clamps at every 2 m. Horizontal runs in cable trays and trenches shall be secured using 4 mm nylon cord at every 2 m.

Cables shall not be bent below the minimum permissible limit. The minimum bending radius of power cables shall be 12D and that of control cables shall be 10D, where D is overall diameter of cable.

Where cables cross roads, drains and rail tracks, the cables shall be laid in reinforced spun concrete or steel pipes, buried at not less than one meter depth.

In each cable run some extra length shall be kept at a suitable point to enable one (for LT Cables) or two (for H.T. cables) straight through joints to be made, should the cable develop fault at a later date.

Selection of cable drums for each run shall be so planned as to avoid using straight through joints. Cable splices will not be permitted except where called for by the drawings, unavoidable or where permitted by the Owner.

Control cable terminations inside equipment enclosures shall have sufficient lengths so that switching of termination in terminal blocks can be done without requiring any splicing.

Metal screen and armour of the cable shall be bonded to the earthing system of the station, wherever required.

Rollers shall be used at intervals of about 2.0 meters, while pulling cables.

All due care shall be taken during unreeling, laying and termination of cable to avoid damage due to twist, kink, sharp bends, etc.

Cable ends shall be kept sealed to prevent damage.

Inspection on receipt, unloading and handling of cables shall generally be in accordance with IS:1255 and other Indian Standard codes or practices.

Wherever cables pass through floor or through wall openings or other partitions, wall sleeves with bushes having a smooth curved internal surface so as not to damage the cables shall be supplied, installed and properly sealed at no extra charges.

The erection work shall be carried out in a neat workmanlike manner and the areas of work shall be cleaned of all scrap materials after the completion of work in each area every day. Contractor shall remove the RCC/steel trench covers before taking up the work and shall replace all the trench covers after the erection work in that particular area is completed or when further work is not likely to be taken up for some time.

Contractor shall furnish three copies of the report on work carried out in a particular week, such as cable numbers and a date on which laid, actual length and route,

testing carried out, terminations carried out, along with the marked up copy of the cable schedule and interconnection drawing wherever the modifications are made.

In case the outer sheath of a cable is damaged during handling/ installation, the Contractor shall repair it at his own cost, and to the satisfaction of the Engineer-in-Charge. In case any other part of a cable is damaged, the same shall be replaced by a healthy cable, at no extra cost i.e. the Contractor shall not be paid for supply, installation and removal of the damaged cable.

All cable terminations shall be appropriately tightened to ensure secure and reliable connections. The Contractor shall cover the exposed part of all cable lugs whether supplied by him or not with insulating type, sleeve or paint.

### **53. Earth Knobs for LT Lines**

#### **1. SCOPE**

This standard covers the requirements of knobs for supporting the neutral-cum-earth wire used for earthing of metal parts of supporting structures of overhead power lines with a nominal voltage upto 1000V (refer Construction Standard B-3 & B-4).

#### **2. APPLICABLE STANDARDS**

Except when they conflict with the specific requirements of this specification, the earth knobs shall conform to the latest version of IS:9511-1980.

#### **3. MATERIALS**

Earth knobs shall be made of cast iron.

#### **4. GENERAL REQUIREMENTS**

Earth knobs shall not have blow holes, shrinkage and other casting defects. The top and bottom flat portion of earth knob shall be smooth and plain.

#### **5. SHAPE AND DIMENSIONS**

The shape and dimensions of earth knob shall conform to Fig. 1.

#### **6. ACCEPTANCE TESTS**

The following acceptance tests shall be carried out atleast on one knob for every 1000 nos.

##### **6.1 Electrical Resistance**

**6.1.1** The electrical resistance of the earth knob shall be measured using a Kelvin bridge. Adequate electrical contact shall be ensured against the two surfaces of the knob preferably by using brass washers, soldered to the leads going to the bridge circuit. The washers shall be of adequate size to ensure sufficient area of contact.

**6.1.2** The electrical resistance of the earth knob, measured as given in 6.1.1 between the two flat portions, shall not exceed 200 m ohms.

##### **6.2 Mechanical Strength**

The breaking strength at the neck of the earth knob shall not be less than 11,500 kg. when force is applied in the direction shown in Fig. 2.

## 7. MARKING

Each earth knob shall be marked with the name of the manufacturer or his trade mark.

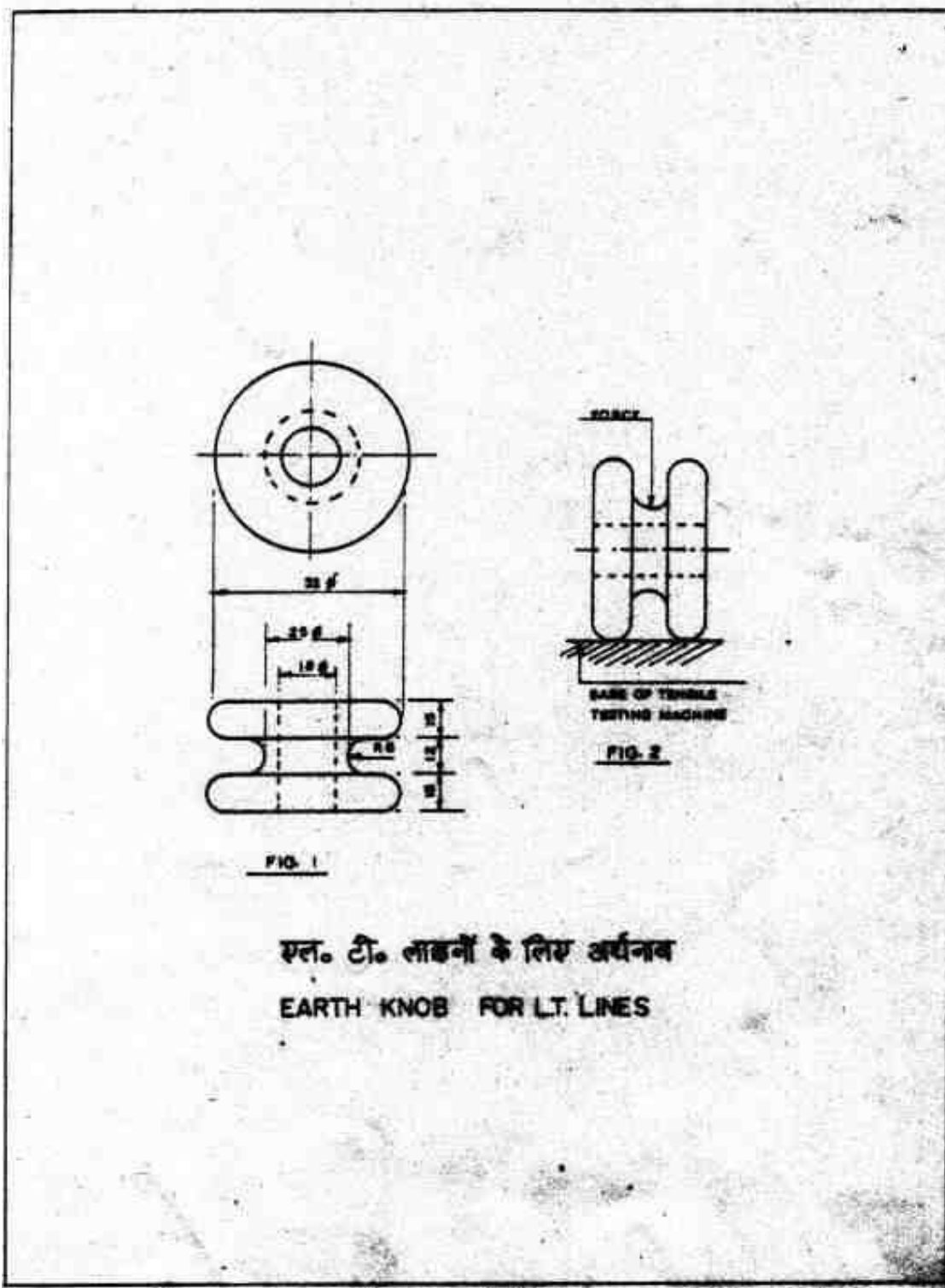



## 54. GI Wires

### 1. SCOPE

This specification covers details of solid G.I. Wires for use in rural distribution system.

### 2. APPLICABLE STANDARDS

Except when they conflict with the specific requirements of this specification, the G.I. wires shall comply with the provisions of IS:280-1978 and IS:7887-1975 or the latest version thereof.

### 3. APPLICATION & SIZES

G.I. wires covered in this Specification are intended for the following applications :

Application	Sizes (nominal dia)
Bearer wire for service	3.15mm (for single phase cables services ) 4 mm ( for three phase services)
Earthing of Transformers, poles & Fittings.	4 mm
Continuous Earthwire for. 11 KV lines	4 mm
Protective guarding at the crossing of over-head power lines with roads, railway tracts and telecommunication lines	3.15, 4 and 5 mm

### 4. MATERIAL

- 4.1** The wires shall be drawn from the wire rods conforming to IS:7887-1975 or the latest version thereof.
- 4.2** The requirements for chemical composition for the wires shall conform to IS:7887.
- 4.3** The wires shall be sound, free from split surface flaws, rough jagged and imperfect edges and other detrimental defects on the surface of the wires.

## 5. GALVANISING

The wires shall be galvanised with 'Heavy Coating' as per IS:4826-1979 or the latest version thereof.

## 6. GRADES

GI wires shall be classified into two grades based on their tensile strength :

Grade	Tensile Strength (MPa)
Annealed	300-550
Hard	550-900

## 7. TOLERANCE IN DIAMETER

The tolerance on nominal diameter at any section of wire shall not exceed ( $\pm$ )2.5%. Further, the maximum difference between the diameters at any two cross-sections of wires shall not exceed 2.5%.

## 8. TESTS

The following tests shall be carried out in accordance with IS:280-1978 or the latest version thereof as per sampling criteria stipulated therein :

- i) Dimensional check (dia) - refer clause 7 above.
- ii) Visual inspection regarding freedom from defects refer clause 4.3 above.
- iii) Tensile test
- iv) Wrapping test (for wire diameters smaller than 5mm)
- v) Bend test (for wire diameters 5mm only)
- vi) Coating test - refer clause 5 above
- vii) Chemical composition

## 9. PACKING

The wires shall be supplied in 50-70 kg. coils, each coil having single continuous length. Each coil of wire shall be suitably bound and fastened compactly and shall be protected by suitable wrapping.

**10. MARKING**

Each coil shall be provided with a label fixed firmly on the inner part of the coil bearing the following information :

- a) Manufacturer's name or trade mark
- b) Lot number and coil number
- c) Size
- d) Grade (Annealed or Hard)
- e) Mass
- f) Length
- g) ISI Certification mark, if any

**55. Hot Dip Galvanised GS Solid Wire**

The hot dip galvanized MS Solid wire of sizes 5 mm, 4 mm and 3.15 mm diameters shall conform to the relevant ISS specification, briefed here below: -

**1) MATERIAL**

The Mild Steel wire shall have the chemical composition maximum sulfur - .055%, Phosphorus – 0.055%, Carbon 0.25%. Zinc shall conform to grade Zen 98 specified in IS 209-1966 & IS: 4826-1979 with up to date amendments.

**2) ZINC COATING**

Zinc coating shall be in accordance with IS: 4826-1979 (Col.4.2.1) for heavily coated hard quality.

**3) GALVANISING**

Galvanizing shall be as per IS 2629-1966, IS: 4826-1979 with up to date amendments.

**4) UNIFORMITY OF ZINC COATING**

Uniformity of Zinc coating shall be as per IS 2633-1972 (Col.4.2.1 to 4.2.3) with up to date amendments.

**5) TENSILE PROPERTIES**

The tensile strength of the wire after, galvanizing shall be between 55-95 Kg/Sq.mm (heavily coated Hard as per IS: 4826-1979 Tables-1) ensuring MS wire Mechanical properties as per IS-28-1972 8.1 to 8.3.

**6) FREEDOM FROM DEFECTS**

As per IS 2629-1966 (Cl.6.1) & 4826-1979 (Col.4.3) & with up to date amendments, be ensured.

**7) TESTS**

During the process of manufacture/ fabrication and finish all tests for chemical, mechanical, galvanizing as per IS-280-1979, IS: 1521-1972, IS1755-1961, IS: 6745-1972 & 4826-1979 be carried out. Test certificate towards, chemical composition (as per above) shall be submitted for each lot offered for inspection.

The following tests shall be conducted in presence of owner's representative.

1. Visual Physical inspection and measurement of specified dimensions.
2. Coating test as per IS-1755-1961, IS: 2629-1966, IS: 2633-1972, IS: 4826-1969 & 1979 – IS: 6745-1972.
3. Adhesion test as per IS: 1755-1961, IS: 2629-1966, IS: 2633-1972, IS: 4826-1969 & 1979 – IS: 6745-1972.
4. Tensile strength and breaking load and elongation determined as per IS 1521-1972 with up to date amendments.

**8) PACKING**

Packing shall be as per IS 280-1979 (Col.3.1) and each coil shall be between 50-100 Kg.

**9) MARKING**

As per IS: 280-1972 (Col.14.1 & 14.1.1) is required.

**56. Material Properties and Other Technical Requirements for Heat Shrinkable Cable Terminations and Joints Suitable for XLPE Cables.**

- 1) **GENERAL:** The term heat shrink refers to extruded or moulded polymeric materials which are cross linked to develop elastic memory and supplied in expanded or deformed size or shape.
- 2) **QUALIFYING EXPERIENCE:** The kits should have satisfactory performance record in India in excess of 5 years supported with proof of customers having had satisfactory use of these kits in excess of 5 years.
- 3) **TYPE TEST REPORTS:** The Joints and terminations should have been type tested and type test reports made available.
- 4) **KITS CONTENTS :** The Kits should generally consist of:
  - (a) Heat shrinkable clear insulating tubes
  - (b) stress control tubing where necessary,
  - (c) Ferrule insulating tubing for joints,
  - (d) Conductive cable break outs for terminations, non tracking, erosion and weather resistant tubing both outer / inner
  - (e) non tracking erosions and weather resistant outdoor sheds in case of terminations
  - (f) high permittivity mastic wedge
  - (g) Insulating mastic.
  - (h) Aluminium crimping lugs of ISI specification.
  - (i) Tinned copper braids
  - (j) Wrap around mechanical protection for joints.
  - (k) Cleaning solvents, abrasive strips.
  - (l) Plumbing metal.
  - (m) Binding wire etc. adequate in quantity and dimensions to meet the service and test conditions.

**The kit shall have installation instructions and shall be properly packed with shelf life of over 3 years.**

## 57. Technical Specification of 66/11 KV Sub-station

### 1. General

This specification covers the design, manufacture, assembly; shop testing, supply, delivery, installation works and field test of the Power Transformers complete with all accessories, fittings and auxiliary equipment for trouble free operation. The transformers shall be oil immersed and suitable for outdoor installation and shall comply with IEC 76/IS 2026.

### 2. Design requirements

The transformers shall be connected to three phase 50 Hz system of 66 kV systems.

The transformer shall be installed outdoor. The transformer shall be oil immersed and designed for the cooling system as specified in Appendix-A.

The transformers shall be capable of operating continuously at its rated output without exceeding the temperature rise limits as specified in Appendix-A.

The transformer windings shall be designed to withstand short circuit stresses at its terminal with full voltage maintained behind it for a period as per IEC-76.

The transformer shall be capable of continuous operation at the rated output under the following conditions:

- a) The voltage varying  $\pm 10\%$  of rated voltage.
- b) Frequency varying  $\pm 5\%$  of the rated frequency.

The transformer shall be capable of delivering its rated output at any tap position.

The transformer shall be free from annoying hum and vibration when in operation even at 10% higher voltage over the rated voltage. The noise level shall be in accordance with respective IEC standards.

The transformer shall be designed and constructed so as not to cause any undesirable interference in radio or communication circuits.

The Transformer Secondary terminal shall be adequately designed for terminating two runs of 1CX800 sqmm cable (to be customized by utility) to it, with the help of appropriate size Outdoor Termination Kit. The cable shall be supported on a structure.

### 3. Construction features

#### 3.1 Tank

The tank shall be of all welded construction and fabricated from sheet steel of adequate thickness. All seams shall be properly welded to withstand

requisite impact during short circuit without distortion. All welding shall be stress relieved.

Stiffener of structural steel for general rigidity shall reinforce the tank wall. The tank shall have sufficient strength to withstand without any deformation by mechanical shock during transportation and vacuum filling in the field.

The tank cover shall be bolted on the tank with weather proof, hot oil resistant, resilient gasket in between for complete oil tightness. If gasket is compressible metallic stops shall be provided to prevent over compression. Bushings, turrets, cover of access holes and other devices shall be designed to prevent any leakage of water into or oil from the tank. The tank cover shall also be provided with two (2) nos. grounding pads and connected separately to tank grounding pads.

The transformer tank shall be provided with sets suitable transporting arrangement

All heavy removable parts shall be provided with eye bolts for ease of handling and necessary lugs and shackles shall be provided to enable the whole transformer to be lifted by a crane or other means. Manholes of sufficient size shall be provided for access to leads, windings, bottom terminals of bushings and taps.

### **3.2 Core & Coils**

The transformer may be of core or shell type. The core shall be built up with interleaved grade non-ageing, low loss, high permeability, grain-oriented, cold rolled silicon steel lamination properly treated for core material. The coils shall be manufactured from electrolytic copper of suitable grade. They should be properly insulated and stacked.

All insulating material shall be of proven design. Coils shall be so insulated that impulse and power frequency voltage stresses are at a minimum.

Insulating spacers and barriers shall suitably support coil assembly. Bracing and other insulations used in the assembly of the winding shall be arranged to ensure a free circulation of the oil and to reduce the hot spot of the winding.

All leads from the windings to the terminal board and bushings shall be rigidly supported to prevent injury from vibration or short circuit stresses. Guide tube shall be used where practicable.

The core and coil assembly shall be securely fixed in position so that no shifting or deformation occurs during movement of transformer or under short circuit stresses.

### **3.3 Tappings**



Off load / on-load taps as specified in Appendices shall be provided on the high voltage winding of the transformers.

The transformer shall be capable of operation at rated output at any tap position provided the primary voltage does not vary by more than  $\pm 10\%$  of the rated voltage corresponding to the normal tap.

The winding, including the tapping arrangement, shall be designed to maintain the electromagnetic balance between H.V. and L.V. winding at all voltage ratios.

### **3.4 On Load Tap Changer (OLTC)**

The continuous current rating of the tap changer shall be based on connected winding rating and shall have liberal and ample margin. Lower rated tap changers connected in parallel are not acceptable.

The tap changing mechanism shall be located in an oil filled compartment separated from the main tank by a suitable oil tight barrier. The oil in OLTC compartment shall have its own separate oil preservation system complete with conservator, Buchholz relay/oil surge relay, breather, shut-off valves, oil level gauge, gas vent etc. However, one segregated compartment of the main conservator tank may be utilized for OLTC oil preservation.

### **3.5 Remote/local Tap Operation**

The on-load tap changing equipment shall have the provision for mechanical and electrical control from a local position. For local mechanical operation, the operating handle shall be brought outside the tank for operation from floor level with provision to lock the handle in each tap position.

In driving mechanism cubicle

- "RAISE-LOWER" control switch
- Means for manual operation when power supply is lost
- Tap change operation counter

The OLTC should be designed to be controlled from the remote. The remote OLTC panel with the switching and control devices shall be provided in the switchgear room.

### **3.6 Insulating Oil**

The insulating oil shall conform to the latest revision of IS 335/IEC publication 296, properly inhibited for preventing of sludging.

The necessary first filling of oil shall be supplied for the transformer in non-returnable container suitable for outdoor storing. Ten percent (10%) excess oil shall also be provided to take wastage into account.

### 3.7 Oil Preservation System

Oil preservation shall be by a means of conservator tank or by a sealed tank system.

#### a) Conservator Tank System

- 1) The conservator tank shall be mounted on a bracket fixed on the tank.
- 2) The conservator tank shall be provided with two compartments, one for the main transformer tank while the other for the OLTC compartment. The partition barrier shall be provided so that OLTC oil shall not be mixed up with the transformers oil under any circumstances.
- 3) One compartment shall be connected with the main transformer tank by pipes through double float Buchholz Relay (gas operated relay) with valves at both ends.
- 4) The other compartment shall be connected with the OLTC compartment by pipes through single float Buchholz Relay/Oil Surge Relay with valves at both ends.
- 5) Contact of the oil in the compartment for the main tank with atmosphere shall be prohibited by using a flexible urethane air cell. The cell shall be vented in to the atmosphere through a silica gel breather and shall inflate or deflate as oil volume changes.
- 6) Both compartments shall be provided with their own breather, filler cap and drain plug.
- 7) Each compartment of the conservator shall be provided with a dial type level indicator visible from the ground level and fitted with a low oil level alarm contact. Plain oil level gauge shall also be provided to each compartment.

### 3.8 Temperature Indicators

One set of winding temperature indicators shall be supplied and fitted locally so as to be readable at a standing height from ground level. Necessary current transformer and heating coil for obtaining thermal images of winding temperatures and a detector element shall be furnished and wired.

The above winding temperature indicator shall be provided with necessary contact to take care of the following:

- (a) Starting of cooling units with rise of temperature
- (b) Alarm on high temperature
- (c) Trip on higher temperature

One set of oil temperature indicator with maximum reading pointer and electrically separate sets of contacts for alarm and trip shall be mounted locally so as to be readable at a standing height from ground level

**3.9 Buchholz relay (Gas operated relay) – (For conservator type of oil preservation)**

The Buchholz relay shall be provided with two floats and two pairs of electrically separate contacts – one pair for alarm and the other pair for tripping.

**3.10 Transformer Bushings**

Transformer bushing at 11 kV side should be so designed to accommodate two no. 800 sq.mm. aluminium (1C) cable (utility to customize based on actual requirement and rating of transformer) with secondary inter phase clearance. All bushings shall conform to the requirements of the latest revisions of IEC publication 137.

The bushings shall be located so as to provide minimum electrical clearances between phase and ground as per relevant IS/IEC standards.

All bushings shall be porcelain type and shall be furnished complete with terminal connectors of adequate capacity. The porcelain used in bushings shall be homogeneous, nonporous, uniformly glazed to brown color and free blisters, burns and other defects.

Stresses due to expansion and contraction in any part of the bushing shall not lead to deterioration.

Bushings rated 66 kV and above shall be of the oil-filled condenser type with a central tube and draw-in-conductor which shall be connected to the connector housed in the helmet of the bushings.

Liquid/oil-filled bushings shall be equipped with liquid level indicators and means for sampling and draining the liquid. The angle of inclination to vertical shall not exceed 30 deg. Oil in oil-filled bushings shall meet the requirements of the transformer oil standards specified.

**3.11 Marshalling Box**

A sheet, steel weatherproof marshalling box of IP-55 construction shall be provided. The box shall contain all auxiliary devices except those which must be located directly on the transformer. All terminal blocks for external cable connections shall be located in this box.

The marshalling box shall have the following but not limited to them:

- a) Load disconnect switch for incoming power supply for auxiliaries.
- b) AUTO-MANUAL selector switch and Local/Remote switch for OLTC
- c) Wiring and termination individually of the following alarm contacts for remote trip and alarm.

- Buchholz relay alarm for main tank (For conservator type).
- Buchholz/oil surge relay alarm for OLTC.

- Winding temperature high alarm.
  - Oil temperature high alarm.
  - Tank oil level low alarm.
  - OLTC oil level low alarm.
  - Tap change incomplete alarm.
- d) Wiring and termination individually of the following trip contact for remote trip and trip alarm.
- Winding temperature high trip.
  - Oil temperature high trip.
  - Buchholz relay trip or sudden gas and sudden oil pressure relay trip.
  - Pressure relief device.

Cubicle illumination lamp with door switch and space heater with thermostat and ON-OFF switch shall be provided.

### **3.12 11 kV Cable Termination**

Adequate support structure with necessary cable support system shall be provided for termination of two (2) 800 sq.mm. XLPE cable/phase on the 11 kV bushings (utility may customize based on actual requirement and rating of transformer). Adequate interphase barrier to be provided between the bushings. Suitable arrangement shall be provided for installation of 11kv surge arrestor near the bushing termination.

### **3.13 Auxiliary Supply**

All indications alarms and trip contacts provided shall be suitable for operation on a nominal 220V DC system for 66 kV Class Transformers.

Tap changing gear shall be suitable for operation of 430V, 3 phase, 4 wire, 50 Hz systems.

Cooling fans shall be rated at 430 V, 3 phase, 50 Hz.

The tap changing and cooler control supply voltage shall be 230V, Single phase 50 Hz.

### **3.14 Current Transformers**

The scope includes the supply and installation of neutral current transformers and all necessary wiring to terminal blocks at the transformer-marshalling kiosk. The specification of requirements for current transformers shall be established and co-coordinated with the 66 kV bay CT and 11 kV switchgear CT.

Neutral current transformers are to be mounted inside the transformer and shall be easily accessible for testing.

### **3.15 Cooler Control Scheme**

The bidder shall design and supply the required cooler control scheme with necessary fans and control gear. One no fan shall be provided as stand by.

#### **4. Tests**

The following tests shall be performed

- i) Insulation resistance tests on bushings.
- ii) Insulation resistance test at 500V between core and core clamping structure.
- iii) Voltage withstand tests on insulating oil to BS:148.
- iv) Voltage ratio.
- v) Phase relationship/Vector Group.
- vi) Magnetisation characteristics of current transformers of winding temperature devices.
- vii) Calibration of winding temperature devices.
  
- viii) Tap selector and diverter switch alignment.
- ix) Calibration of automatic voltage control equipment.
- x) Proving tests as necessary on control schemes.
- xi) Proving tests of buchholz device by air injection.
- xii) Impedance voltage at highest rated and lowest voltage tap.
- xiii) Zero sequence impedance at rated voltage tap.
- xiv) DC resistance at all voltage taps.
- xv) Core balance test.
- xvi) Tan delta-capacitance test on bushings (66kV).
- xvii) Tan delta-capacitance test on transformer.

#### **5. Losses at 75 deg Celsius at rated voltage shall be not higher than the values indicated below (IS2026 along with latest amendments if any):**

- a) No load losses (Iron losses): 15 MVA- 10 kW, 20 MVA -14.5 kW
- b) Full load (Copper losses + stray losses) losses: 15 MVA-56 kW, 20 MVA- 73 kW

#### **6. Tender evaluation & capitalization of transformer losses**

Conditions of contract at Part - 3 may be referred for this.

The minimum loss indicated by any of the bidder will be taken as a base for computing any Liquidated damages for non-performance of the equipment and LD shall be levied as per GCC clause 24.1, 24.2 and corresponding clause 11 and 12 at SCC.

#### **7. Performance guarantee**

The performance figures quoted on Technical Data Sheet shall be guaranteed within the tolerances permitted by standards IS 2026 & IEC 76 and will become a part of the successful Bidder's Contract.

## **8. Drawings, data & manuals**

Submission of Drawings, Data & Manuals by the Bidder along with the tender Document and that after the award of contract for approval shall be as follows:

- a) The following drawings and details shall be furnished along with the Tender.
  - 1) Bidder's proposed typical general arrangement drawing showing constructional features of:
    - Tank including conservator, level gauge, etc.
    - Bushing configuration arrangement
    - Cable termination arrangement
    - Wheel base dimension and detail
    - Head clearance required for detanking of coil assembly.
  - 2) Test certificates of similar transformer as quoted.
  - 3) Technical leaflets on accessories such as:
    - Buchholz relay, sudden gas pressure/oil pressure relay
    - Temperature indicators
    - Tap changer
    - High/Low voltage bushings
  
- b) After Award of Contract

After award of contract, the successful Bidder shall submit the required number of copies of following data for approval.

- 1) Outline dimensional drawing showing the general arrangement, indicating the space required for:
  - Cable termination arrangement
  - Wheel base dimension & detail
- 2) Head clearance required for detanking of core and coil assembly.
- 3) Foundation plan and loading.
- 4) Transport/shipping dimension with net weight and weights of various parts.
- 5) Final calculation of impedance for each transformer.

- 6) Schematic flow diagram of cooling system showing the number of cooling units, etc.
- 7) Technical details along with control schematic and wiring diagram for marshalling box, remote tap changer control panel.
- 8) Short circuits withstand capacity design calculation.

Any other relevant data, drawing and information necessary for review of the items whether specifically mentioned or not, shall be furnished along with this information.

The general arrangement drawing, the schematic wiring diagram showing the control scheme, cable termination arrangement, location of terminal blocks, etc., shall be submitted for comment/approval. The Employer/Engineer will return these drawings after their review with their comments and/or approval. The review and comments will generally be made on the schematic diagram drawing and the configuration and the arrangement of the accessories fitted on the transformer. The Bidder on receipt of their returned drawings, with comments from the Employer/Engineer, shall prepare final wiring diagram. The outgoing terminals of the wiring diagram shall be specifically indicated for different functions, such as closing, tripping, alarm, indication, etc. The responsibility for correctness of the wiring diagram shall lie with the Bidder.

Employer/Engineer will only check the final schematic diagram after submission. If any modification, addition or alternation is considered necessary thereon to comply with the Employer/Engineer approved schematic drawing stated hereinabove, the said modification, addition or alternation shall be carried out by the Bidder either in their works if it is before delivery or at site after delivery at no cost to the Employer.

## **9. Nameplate**

Each transformer shall be provided with a nameplate of weather resistant material fitted in a visible position showing but not limited to the following item:

- a) Kind of transformer
- b) Number of the specification
- c) Manufacturer's name
- d) Year of manufacture
- e) Manufacturer's serial number
- f) Number of phases and frequency
- g) Rated power
- h) Rated voltages and currents
- i) Connection symbol
- j) Impedance voltage at rated current

- k) Type of cooling
- l) Total weight
- m) Weight of insulating oil
- n) Class of insulation
- o) Temperature rise
- p) Connection diagram
- q) Insulation levels
- r) Weight of transportation and untanking
- s) Details regarding tapping's

## 10. Transportation

The core and coils shall be completely dried before shipment and assembled with tank and with oil or dry nitrogen depending upon the size of the transformers. In order to facilitate handling and shipping, as many external accessories as practical, including bushings shall be removed and replaced by special shipping covers.

Bushings, radiators and other accessories which may be affected by moisture shall be packed in moisture proof containers.

**CODES & STANDARDS (refer Clause 1 of this Part-2, Power Transformer Specification)**

### APPENDIX-A TECHNICAL PARTICULARS OF 66/11 kV TRANSFORMER

1	Rating ONAN	12.5 MVA, 15 MVA
	ONAF	20 MVA
2	Voltage Ratio	66/11.5 kV
3	Percentage impedance (at nominal Tap) voltage at 20 MVA and 75 deg. C	As per IS
4	Service	Outdoor
5	Type	Oil-immersed



6	Type of cooling		ONAN/ ONAF
7	Temperature rise above 50 deg. C ambient temperature		
	a)	In oil by thermometer	45 deg. C
	b)	In winding by resistance	55 deg. C
8	Number of phase and frequency		3 phase, 50 Hz
9	Maximum voltage		
	a)	Primary	72 kV
	b)	Secondary	12 kV
10	Rated voltage (line to line)		
	a)	Primary	66 kV
	b)	Secondary	11 kV
11	Insulation level of winding		
	a)	Basic impulse level as per IEC 76	
		- Primary	325 kV
		- Secondary	75 kV
	b) Power frequency induced over voltage (1 min.)		
		- Primary	140 kV
		- Secondary	28 kV
12	Connection		
	a) Primary		Delta
	b) Secondary		Star
13	Vector group reference Primary – Secondary		Dyn11
14	Type of tap changer	On-load, capacity	full

15	Taps provided on	HV Winding
16	Range of taps	-10 To 10%
17	Number of taps	9
18	Method of tap change control	
	Mechanical local	Yes
	Electrical local	Yes
	Electrical remote with "AUTO-MANUAL" selection	yes
19	System grounding	
	a) Primary	Solidly grounded
	b) Secondary	Solidly grounded
20	System fault level	31.5 kA at 66 kV
21	Neutral terminals	
	a) Primary	Yes
22	Neutral CT	
	a) LV SIDE	2- CORE (One-PS, One – 5p20)
	Neutral CT Details	
	CT TYPE LV	NEUTRAL CT
	5P20	RATIO:1600/1
	PS	RATIO: 1600/1
		Vk=800V
		Rct+2Rl<10

## POWER TRANSFORMERS

### APPENDIX-B : TRANSFORMER ACCESSORIES

The transformer furnished under this specification shall be equipped with the following:

- \*1. Oil conservator with two compartments each with filler caps and drain plugs.
- \*2. Two sets of silica gel breathers with connecting pipe and oil seal.
- \*3. Air release plug.
- \*4. Double float Buchholz Relay with electrically separate trip and alarm contacts for transformer tank.
- \*5. Two Nos. of shut-off valves at both sides of each Buchholz Relay.
- \*\*6. Sudden oil pressure relay with trip contact.
- \*\*7. Sudden gas pressure relay with trip contact.
- \*\*8. Pressure vacuum bleeder.
- 9. Mechanically operated self-resetting type pressure relief device with visible operation indicator and trip contact.
- 10. One (1) no. 150 mm Dial Magnetic oil level gauge with low level alarm contact (one for main tank and one for OLTC).
- 11. Direct Reading Plain oil level gauge-two (2) Nos.
- 12. 150 mm Dial oil Temperature indicator with maximum reading pointer and individually adjustable electrically separate sets of contact for alarm and trip.
- 13. 150 mm Dial Winding Temperature Indicator with individually adjustable electrically separate sets of contact for two stage cooler control, alarm and trip with detector element complete with heating coil, CT's etc.
- 14. Single float Buchholz Relay/Oil Surge Relay with alarm contact for OLTC.
- 15. Drain valve with threaded adaptor.
- 16. Sample valve (top and bottom)
- 17. Filter valves with threaded adaptor (top and bottom)
- 18. Manhole of sufficient size for access to the interior of the tank.
- 19. Cover lifting eyes.
- 20. Jacking pads, hauling and lifting lugs.
- 21. Bi-directional flanged wheels.
- 22. Skids.
- 23. Clamping device with nuts and bolts for clamping the transformer on foundation rails.

24. Ladder with safety device for access to the transformer to and Buchholz Relay.
25. Two (2) Nos. grounding pads each with two (2) Nos. tapped holes, bolts and washers for transformer tank, radiator bank and cable-end box grounding.
26. Rating plate and terminal marking plate.
27. Marshalling box for housing control equipment and terminal connections.
28. Cooling system complete with isolation valves and all necessary accessories.
29. HV and LV termination arrangement suitable for termination of cables.
30. Neutral bushing complete with connections.
31. One no PRV.
  - \* For conservator type of oil preservation system.
  - \*\* For sealed tank type of oil preservation system.

**58. 66 kV CIRCUIT BREAKER (OUTDOOR TYPE)****1. General**

66 kV Circuit Breakers shall be outdoor type, comprising three identical single pole units, complete in all respects with all fittings and wiring. The circuit breakers and accessories shall conform to IEC-62271-100 or equivalent Indian Standard.

**2. Duty requirements**

- 2.1 Circuit breaker shall be suitable for 3 phase, 50 Hz, 66 kV System. The circuit breaker shall meet the duty requirement of any type of fault or fault location, when used on 66 kV effectively grounded or ungrounded systems and perform make and break operations as per the stipulated duty cycles satisfactorily.
- 2.2 The rated transient recovery voltage for terminal fault and short line faults shall be as per IEC:62271-100.
- 2.3 The circuit breakers shall be reasonably quiet in operation. Noise level in excess of 140 dB measured at base of the breaker would be unacceptable. Bidder shall indicate the noise level of breaker at distance of 50 to 150 m from base of the breaker.
- 2.4 The Bidder may note that total break time of the breaker shall not be exceeded under any duty conditions specified such as with the combined variation of the trip coil voltage, pneumatic pressure and arc extinguishing medium pressure, etc.
- 2.5 While furnishing particulars regarding the D.C. component of the circuit breaker, the Bidder shall note that IEC-62271-100 requires that this value should correspond to the guaranteed minimum opening time under any condition of operation.
- 2.6 The critical current which gives the longest arc duration at lock out pressure of extinguishing medium and the duration shall be indicated.
- 2.7 All the duty requirements specified above shall be provided with the support of adequate test reports to be furnished along with the bid.

- 3. Principle Technical Parameters:** - The SF6 gas Circuit Breakers covered in this specification shall meet the technical requirement listed hereunder.

1	Type of circuit breaker	Outdoor SF6 type
2	Rated frequency	50 Hz
3	Number of poles	Three (3)
4	Reclosing duty cycle	O - 0.3 Sec. - CO – 15 Sec.-CO
5	Rated short circuit breaking current at rated voltage	31.5 kA with percentage of DC component as per IEC56 corresponding to minimum opening time under

		operating conditions specified
6	Symmetrical interrupting Capability	31.5 kA rms
7	Short time current carrying Capability	31.5 kA rms for one (1) second
8	Rated normal current in amps.	800A (utility to customize based on actual requirement)
9	Total break (opening time)	60 m sec. (3 cycles)
10	Reclosing	Three phase high speed auto reclosing (as required)
11	Total closing time	100 ms
12	Trip and closing coil voltage	As per substation D.C. Voltage
13	Auxiliary contacts	As required plus 8NO and 8NC contacts per pole as spare. The contacts shall have continuous rating of 10A and breaking capacity of 2A with circuit time constant of minimum 20 millisecond at 220V DC (Typ.)
14	Temperature rise over Ambient	As per IEC:62271-100
15	Type of operating mechanism	Spring charging
16	Rated ambient temperature	50 deg. Centigrade
17	Seismic acceleration	0.3g horizontal
18	Rated voltage	66 kV (rms)
19	Rated one minute power frequency withstand voltage (Dry and Wet)	170 kV rms
20	Rated lightning impulse withstand voltage (1.2/50 Micro-Sec.)	325 kVp
21	No. of Terminals in common control cabinet	All contacts to be wired to common control cabinet with 24 extra terminal blocks.

#### 4. Constructional features

4.1 All making and breaking contacts shall be sealed and free from atmospheric effect. In the event of leakage of extinguishing medium to a value, which cannot withstand the dielectric stresses specified in the open position, the contacts shall preferably self-close. Main contacts shall be first to close and the last to open and shall be easily accessible for inspection and replacement. If

there are no separately mounted arcing contacts, then the main contacts shall be easily accessible for inspection and replacement. Main contacts shall have ample area and contact pressure for carrying the rated current under all conditions. The interrupter sectional drawing showing the following conditions shall be furnished for information with the bid:

- a) Close position
- b) Arc initiation position
- c) Full arcing position
- d) Arc extinction position
- e) Open position.

4.2 All the three poles of the breaker shall be linked together electrically.

4.3 Circuit breakers shall be provided with two (2) independent trip coils, suitable for trip circuit supervision. The trip circuit supervision relay would also be provided. Necessary terminals shall be provided in the central control cabinet of the circuit breaker.

## **5. Sulphur hexafluoride (SF<sub>6</sub>) gas circuit breaker**

5.1 Circuit breakers shall be single pressure type.

5.2 Design and construction of the circuit breaker shall be such that there is minimum possibility of gas leakage and entry of moisture. There should not be any condensation of SF<sub>6</sub> gas on insulated surfaces of the circuit breaker.

5.3 In the interrupter assembly, there shall be absorbing product box to eliminate SF<sub>6</sub> decomposition products and moisture. The details and operating experience with such filters shall be brought out in additional information schedule.

5.4 Each pole shall form an enclosure filled with SF<sub>6</sub> gas independent of two other poles. Common monitoring of SF<sub>6</sub> gas can be provided for the three poles of circuit breaker having a common drive. The interconnecting pipes in this case shall be such that the SF<sub>6</sub> gas from one pole could be removed for maintenance purposes.

5.5 Material used in the construction of circuit breakers shall be such as fully compatible with SF<sub>6</sub>.

5.6 The SF<sub>6</sub> gas density monitor shall be adequately temperature compensated to model the density changes due to variations in ambient temperature within the body of circuit breaker as a whole. It shall be possible to dismantle the monitor without removal of gas.

5.7 Sufficient SF<sub>6</sub> gas shall be supplied to fill all the circuit breakers installed plus an additional 10% of the quantity as spare.

## **6. Operating mechanism**

6.1 Circuit breaker shall be operated by electrically spring charged mechanism.

6.2 The operating mechanism shall be anti-pumping and trip free (as per IEC definition) electrically and either mechanically or pneumatically under every method of closing. The mechanism of the breaker shall be such that the position

of the breaker is maintained even after the leakage of operating media and/or gas.

- 6.3 The operating mechanism shall be such that the failure of any auxiliary spring will not prevent tripping and will not cause trip or closing operation of the power operated closing devices. A mechanical indicator shall be provided to show open and close positions of breaker. It shall be located in a position where it will be visible to a man standing on the ground with the mechanism housing door closed. An operation counter shall also be provided.
- 6.4 Closing coil shall operate correctly at all values of voltage between 85% and 110% of the rated voltage. Shunt trip coils shall operate correctly under all operating conditions of the circuit breaker upto the rated breaking capacity of the circuit breaker and at all values of supply voltage between 70% and 110% of rated voltage. If additional elements are introduced in the trip coil circuit their successful operation for similar applications of outdoor breaker shall be clearly brought out in the bid.
- 6.5 Working parts of the mechanism shall be of corrosion resisting material. Bearings requiring grease, shall be equipped with pressure type grease fittings. Bearing pin, bolts, nuts and other parts shall be adequately pinned or locked to prevent loosening or changing adjustment with repeated operation of the breaker.
- 6.6 Operating mechanism shall normally be operated by remote electrical control. Electrical tripping shall be performed by shunt trip coil. Provision shall also be made for local electrical control. 'Local/remote' selector switches and closes & trip push buttons shall be provided in the breaker central control cabinet. Remote located push buttons and indicating lamps shall also be provided.
- 6.7 Operating mechanism and all accessories shall be in local control cabinet. A central control cabinet for the three poles of the breaker shall be provided along with supply of necessary tubing, cables, etc.
- 6.8 Provisions shall be made on breakers for attaching an operation analyser to perform speed tests after installation at site to record contact travel against time and measure opening time.
- 6.9 The Bidder shall furnish curve supported by test data indicating the opening time under close-open operation with combined variation of trip coil and operating media along with the bid.

#### **6.10 Spring Operated Mechanism**

Spring operated mechanism shall be complete with motor, opening spring & closing spring with limit switch for automatic charging and other necessary accessories to make the mechanism a complete operating unit. Opening spring shall be supplied with limit switch for automatic charging and other necessary accessories.

As long as power is available to the motor, a continuous sequence of closing and opening operations shall be possible. The motor shall have adequate thermal rating for this duty. After failure of power supply to the motor, one



close-open operation shall be possible with the energy contained in the operating mechanism.

Breaker operation shall be independent of the motor, which shall be used solely for compressing the closing spring.

Motor ratings shall be such that it requires not more than 30 seconds for fully charging the closing spring.

Closing action of the circuit breaker shall compress the opening spring ready for tripping.

When closing springs are discharged, after closing a breaker, closing springs shall automatically be charged for the next operation and an indication of this shall be provided in the local and remote control cabinet.

The spring operating mechanism shall have adequate energy stored in the operating spring to close and latch the circuit breaker against the rated making current and also to provide the required energy for the tripping mechanism in case the tripping energy is derived from the operating mechanism.

## **6.11 Fittings and Accessories**

6.11.1 Following is list of some of the major fittings and accessories to be furnished as integral part of the breakers. Number and exact location of these parts shall be indicated in the bid.

6.11.2 **Control unit/Central control cabinet** shall be complete with:

- a) Double compression type cable glands, lugs, ferrules, etc.
- b) Local/remote changeover switch
- c) Operation counter
- d) Fuses, as required
- e) Anti-pumping relay/contactors
- g) Rating and diagram plate in accordance with IEC including year of manufacture, etc.
- h) Gauges for SF6 gas pressure.
- i) Gas density monitor with alarm and lockout contacts

## **7. Fittings and accessories**

### **7.1 Hollow insulator columns**

All routine tests shall be conducted on the insulators as per relevant IEC. In addition the following routine tests shall also be conducted on hollow column insulators:

- a. Ultrasonic test

- b. Pressure test
- c. Bending load test in 4 directions at 50% specified bending load.
- d. Bending load test in 4 directions at 100% specified Bending load as a sample test.
- e. Burst pressure test as a sample test.

## 7.2 Support Structures

The minimum height of equipment supports shall be 3050 mm. The height of center line shall be as given elsewhere in the specification.

## 7.3 Terminal connectors

Compression joint type terminal connectors suitable for single or twin ACSR panther/zebra/Moose conductor shall be supplied and they shall be suitable for both vertical and horizontal connections of the Transmission line conductor or station bus bar. Suitable terminal earth connectors (two Nos.) for earthing connections shall also be supplied. The drawings for these connectors shall be submitted.

The terminal connectors shall meet the following requirements:

- a) Terminal connectors shall be manufactured and tested as per IS:5561.
- b) All castings shall be free from blow holes, surface blisters, cracks and activities. All sharp edges & corners shall be blurred and rounded off.
- c) No part of a clamp shall be less than 10 mm thick.
- d) All ferrous parts shall be hot dip galvanised conforming to IS:2633.
- e) For bimetallic connectors, copper alloy liner of minimum thickness of 2 mm shall be cast integral with aluminium body.
- f) Flexible connectors shall be made from tinned copper/ aluminium sheets.
- g) All current carrying parts shall be designed and manufactured to have minimum contact resistance.
- h) Connectors shall be designed to be corona free in accordance with the requirements stipulated in IS:5561.

## 8. Tests

### 8.1 Type Test

Each circuit breaker shall comply with the type test and shall be subjected to routine tests prescribed in latest edition of IEC-62271/IEC-60694/IS-13118.

Reports of all type tests as stipulated in IEC-62271, IEC-60694 or IS-13118 and line charging current and cable charging current and transformer charging & shunt capacitor switching current tests etc. as given below carried out by internationally recognized test laboratories shall be furnished. Supply from those original equipment manufacturers shall be accepted who are having type test certification for following test in past 5 years and the type and design of the breakers then intend to supply are exactly similar. The type test reports shall be produced in support of sub vender / vender of supply of breaker in quantity more than 25 the supplier shall conduct all following test free of charges in presence of Employer's representative.

In case some type tests are conducted at Manufacturer's own works, instead of at Govt. approved laboratory, the type test reports for same shall be accepted only if tenderer undertakes to conduct this type test free of charges in presence of Utility representative at time of inspection.

- i) Impulse withstand voltage test
- ii) Power frequency voltage withstand dry test on main circuit
- iii) Short circuit withstand capability test
- iv) Mechanical endurance test
- v) Temperature rise test
- vi) Radio interference voltage (RIV)
- vii) Measurement of the resistance of main circuit
- viii) Short time withstand current and peak withstand current test
- ix) Out of phase making & breaking test
- x) Shunt reactor current switching test
- xi) Dielectric test
- xii) IP-55 test on operating mechanism
- xiii) Seismic test
- xiv) Cable charging current switching test
- xv) Line charging current switching test
- xvi) Capacitor current switching test for isolated neutral capacitor banks.
- xviii) Degree of protection test on cubicles

## **8.2 Routine Tests**

Routine tests as per IEC-60056 on the complete breaker/ pole along with its own operating mechanism and pole column shall be performed on all circuit breakers.

## **8.3 Acceptance tests:**

The following acceptance tests as stipulated in the relevant ISS-13118 shall be carried out by the Manufacturer in presence of employer representative, unless dispensed with in writing by the employer.

- i) Power frequency voltage withstand dry test on main circuit

- ii) Voltage withstand test on control and auxiliary circuits
- iii) Measurement of resistance of the main circuit
- iv) Mechanical operating test
- v) Design and visual test
- vi) Tightness Test

In addition to above, speed curves for each breaker shall be obtained with the help of a suitable operation analyzer to determine the breaker contact movement during opening, closing, auto-re-closing and trip free operations under normal as well as limiting operating conditions (of control voltage) The tests shall show the speed of contacts directly at various stages of operation, travel of contacts, opening time, closing time, shortest time between separation and meeting of contacts at make-break operation and dynamic contact resistance measurement (DCRM) etc. Also, results obtained in type test analysis as stipulated in clause 8.1 shall be examined for acceptance before release of dispatch clearance for the lot.

**9. Completeness of equipment:**

Any fittings, accessories or apparatus which may not have been specifically mentioned in this specification but which are usually necessary for the satisfactory operation of the equipment, shall be deemed to have been included in this specification.

**10. Packings:**

All material shall be suitably packed for transport, direct to site and Manufacturer shall be responsible for all damages/losses due to improper packing. All boxes shall be marked with signs indicating the up and down sides of the boxes along with the unpacking instructions, if considered necessary by the Manufacturers.

## 59. 66KV ISOLATORS

### 1. General

The isolators and accessories shall conform in general to IEC-62271-102 except to the extent explicitly modified in specification.

Earth switches shall be provided on isolators wherever called for.

The isolators and earth switches shall be manually operated.

Complete isolator with all the necessary items for successful operation shall be supplied.

Isolators shall be gang-operated, double break or centre break.

### 2. Duty requirements

Isolators and earth switches shall be capable of withstanding the dynamic and thermal effects of the maximum possible short circuit current of the system in their closed position. They shall be constructed such that they do not open under influence of short circuit current and wind pressure together. The earth switches wherever provided shall be constructional interlocked so that the earth switches can be operated only when the isolator is open and vice-versa.

In addition to the constructional interlock, isolator and earth switches shall have provision to prevent their electrical and manual operation unless the associated and other interlocking conditions are met.

Castel lock type interlock mechanism shall be provided in addition to normal mechanical interlock for-

- (a) Breaker and isolator closing
- (b) Isolator and earth switch closing.

The isolator shall be capable for making/breaking normal currents when no significant change in voltage occurs across the terminals of each pole of the isolator on account of making/breaking operation.

### 3. Constructional features

The isolators shall be provided with high pressure current carrying contacts on the hinge/jaw ends and all contact surfaces shall be silver plated Copper alloy. The contacts shall be accurately machined and self-aligned. They shall be easily replaceable and shall have minimum movable parts and adjustments.

The isolator shall be provided with a galvanized steel base provided with holes and designed for mounting on a lattice/pipe support structure. The base shall be rigid and self-supporting.

All metal parts shall be of non-rusting and non-corroding metal. Current carrying parts shall be from high conductivity electrolytic copper/aluminium. Bolts, screws and pins shall be provided with lock washers. Keys or equivalent locking facilities, if provided on current

carrying parts, shall be made of copper alloy or equivalent. The live parts shall be designed to eliminate sharp joints, edges and other corona producing surfaces.

The isolators shall be so constructed that the switch blade will not fall to the closed position if the operating shaft gets disconnected. Isolators and earthing switches including their operating parts shall be such that they cannot be dislodged from their open or closed positions by gravity, wind pressure, vibrations shocks or accidental touching of the connecting rods of the operating mechanism. The switch shall be designed such that no lubrication of any part is required except at very infrequent intervals.

The insulator of the isolator shall conform to the requirements stipulated in relevant IS. Pressure due to the contact shall not be transferred to the insulators after the main blades close. The insulators shall be so arranged that leakage current will pass to earth and not between terminals of the same pole or between phases.

#### **4. Clamps and connectors**

The material of clamps and connectors shall be Aluminium alloy casting conforming to designation A6 of IS:617 for connecting to equipment terminals and conductors of aluminium. In case the terminals are of copper, the same clamps/connectors shall be used with 2mm thick bimetallic liner.

The material of clamps and connectors shall be Galvanised mild steel for connecting to shield wire.

Bolts, nuts and plain washers shall be hot dip galvanised mild steel for sizes M12 and above. For sizes below M12, they shall be electro-galvanised mild steel. The spring washers shall be electro-galvanised mild steel.

All castings shall be free from blow holes, surface blisters, cracks and cavities. All sharp edges and corners shall be rounded off to meet specified corona and radio interference requirements.

They shall have same current rating as that of the connected equipment. All current carrying parts shall be at least 10 mm thick. The connectors shall be manufactured to have minimum contact resistance.

Flexible connectors, braids or laminated strips shall be made up of copper/aluminium.

Current rating and size of terminal/conductor for which connector is suitable shall be embossed/punched on each component.

#### **5. Earthing switches**

Where earthing switches are specified these shall include the complete operating mechanism and auxiliary contacts. The earthing switches shall form an integral part of the isolator and shall be mounted on the base frame of the isolator. Earthing switches shall be suitable for local operation only. The earthing switches shall be constructional interlocked

with the isolator so that the earthing switches can be operated only when isolator is open and vice versa.

**6. Operating mechanism and control**

The Manufacturer shall offer manual isolators and earth switches having padlock arrangement on both 'ON' and 'OFF' positions.

Limit switches for control shall be fitted on the isolator/earth switch shaft, within the cabinet to sense the open and close positions of the isolators and earth switches.

It shall not be possible, after final adjustment has been made for any part of the mechanism to be displaced at any point in the travel sufficient enough to allow improper functioning of the isolator when the isolator is opened or closed at any speed.

Control cabinet/operating mech. Box shall conform to requirements stipulated in IS: 5039/IS 8623/IEC 439.

**7. Operation**

The design shall be such as to provide maximum reliability under all service conditions. All operating linkages carrying mechanical loads shall be designed for negligible deflection.

The design of linkages and gears be such so as to allow one man to operate the handle with ease for isolator and earth switch.

**8. Tests**

In continuation to the requirements stipulated under Part-I the isolator along with operating mechanism shall conform to the type tests and shall be subjected to routine tests and acceptance tests in accordance with IEC-62271-102. Minimum 50 nos. mechanical operations will be carried out on 1 (one) isolator assembled completely with all accessories as acceptance test. During final testing of isolator, closing/ opening of earth switch shall also be checked after isolator is fully open/close. Acceptance test shall be carried out with operating box.

The insulator shall conform to all the type tests as per IEC-60168. In addition to all type, routine and acceptance tests, as per IEC-60168, the following additional routine/ acceptance tests shall also be carried out:

- a) Bending load test in four directions at 50% min. bending load guaranteed in all insulators.
- b) Bending load test in four directions at 100% min. bending load guaranteed on sample insulators in a lot.
- c) Torsional test on sample insulator of a lot.

**The type test reports shall not be older than FIVE years and shall be valid up to expiry of validity of offer.** The above additional lists if not conducted earlier, shall be done under the subject project package at no extra cost.

**9. Parameters**

- 9.1. General** (for General & 11 kV, refer Tech specification Section 6 of Part -2 )
- 9.2. 66 kV Class Isolators** (to be customized by utility as per requirements and capacity)

a)	Rated voltage	72 kV (rms)
b)	Rated continuous current	Minimum 800 A at rated ambient temperature
c)	Rated Insulation levels	
i)	Rated one minute power frequency withstand voltage	i) 140 kV (rms) between live terminals and earth. ii) 162 kV rms across isolating distance
ii)	Rated lightning impulse withstand voltage	i) $\pm 325$ kVp between live terminals and earth ii) $\pm 325$ kV rms across isolating distance
d)	Phase to phase spacing	2000 mm

**10. Completeness of equipment:**

Any fittings, accessories or apparatus which may not have been specifically mentioned in this specification but which are usually necessary for the satisfactory operation of the equipment, shall be deemed to have been included in this specification.

**11. Packings:**

All material shall be suitably packed for transport, direct to site and Manufacturer shall be responsible for all damages/losses due to improper packing. All boxes shall be marked with signs indicating the up and down sides of the boxes along with the unpacking instructions, if considered necessary by the Manufacturers.



## 60. 66KV INSTRUMENT TRANSFORMERS (Utility to customize based on actual requirement)

### 1 Codes and standards

i)	Current Transformers	IEC 60044, BS:3938, IS: 2705
ii)	Voltage Transformers	IEC 60186, IEC 186A, IEC 60358, IS:3156
iii)	Insulating Oil	IS:335

### 2 General requirements

The instrument transformers i.e. current and voltage transformers shall be single phase transformer units and shall be supplied with a common marshaling box for a set of three single phase units.

The instrument transformers shall be hermetically sealed units. The instrument transformers shall be provided with filling and drain plugs.

Polarity marks shall indelibly be marked on each instrument transformer and at the lead terminals at the associated terminal block.

The insulators shall have cantilever strength of more than 600 kgf.

### 3 Current Transformers (CTs)

3.1. The CTs shall have single primary of either ring type or hair pin type or bar type.

3.2. In case of "Bar Primary" inverted type CTs, the following requirements shall be met.

3.3. The secondaries shall be totally encased in metallic shielding providing a uniform equipotential surface for even electric field distribution.

3.4. The lowest part of insulation assembly shall be properly secured to avoid any risk of damage due to transportation stresses.

3.5. The upper part of insulation assembly sealing on primary bar shall be properly secured to avoid any damage during transportation due to relative movement between insulation assembly and top dome.

3.6. The insulator shall be one piece without any metallic flange joint.

3.7. The CT shall be provided with oil sight glass.

3.8. The core lamination shall be of cold rolled grain oriented silicon steel or other equivalent alloys. The cores shall produce undistorted secondary current under transient conditions at all ratios with specified parameters.

- 3.9. Different ratios shall be achieved by secondary taps only, and primary reconnections shall not be accepted.
- 3.10. The guaranteed burdens and accuracy class are to be intended as simultaneous for all cores.
- 3.11. The instrument security factor at all ratios shall be less than five (5) for metering core. If any auxiliary CT/reactor is used, then all parameters specified shall be met treating auxiliary CTs/reactors as integral part of CT. The auxiliary CT/reactor shall preferably be in-built construction of the CT. In case it is separate, it shall be mounted in secondary terminal box.
- 3.12. The physical disposition of protection secondary cores shall be in the same order as given under CT requirement table(s) given below.
- 3.13. The CTs shall be suitable for high speed auto-reclosing.
- 3.14. The secondary terminals shall be terminated on stud type non-disconnecting terminal blocks inside the terminal box of degree of protection IP:55 at the bottom of CT.
- 3.15. The CTs shall be suitable for horizontal transportation.

#### **4 Voltage Transformers (CVTs)**

- 4.1. Voltage transformers shall be of capacitor voltage divider type with electromagnetic unit.
- 4.2. The CVTs shall be thermally and dielectrically safe when the secondary terminals are loaded with guaranteed thermal burdens.
- 4.3. The electro-magnetic unit (EMU) shall comprise of compensating reactor, intermediate transformer, and protective and damping devices. The oil level indicator of EMU with danger level marking shall be clearly visible to maintenance personnel standing on ground.
- 4.4. The secondaries shall be protected by HRC cartridge type fuses for all windings. In addition fuses shall also be provided for protection and metering windings for connection to fuse monitoring scheme. The secondary terminals shall be terminated on stud type non-disconnecting terminal blocks via the fuse inside the terminal box of degree of protection IP:55. The access to secondary terminals shall be without the danger of access to high voltage circuit.
- 4.5. The damping device shall be permanently connected to one of the secondary winding and shall be capable of suppressing ferro-resonance oscillations.
- 4.6. A protective surge arrester/spark gap shall preferably be provided to prevent break down of insulation by incoming surges and to limit abnormal rise of terminal voltage of shunt capacitor, tuning reactor, RF choke, etc. due to short circuit in transformer secondary. The details of this arrangement (or alternative arrangement) shall be furnished by Bidder for Employer's review.

4.7. The accuracy of metering core shall be maintained through the entire burden range upto 100VA on all three windings without any adjustments during operations.

### 5 Marshalling box (CT/PT MB)

Marshaling box shall conform to all requirements as given in technical specification for LT Switchgear & DB. The wiring diagram for the interconnection of three phase instrument transformer shall be pasted inside the box in such a manner so that it is visible and it does not deteriorate with time. Terminal blocks in the marshaling box shall have facility for star/delta formation, short circuiting and grounding of secondary terminals. The box shall have enough terminals to wire all control circuits plus 20 spare terminals.

### 6 Parameters for current transformers

(Utility to customize based on actual requirement)

a)	Rated primary current	800 A
b)	Rated dynamic current	80 kA (peak)
c)	One minute power frequency withstand voltage between secondary terminal and earth	5 kV
d)	Partial discharge level	10 Pico Coulombs max.
e)	Temperature rise	As per IEC 60044
f)	Type of insulation	Class A
g)	Number of cores	Five (5): Details are given in Table-I below.
h)	Rated frequency	50 Hz
i)	System neutral earthing	Effectively earthed
j)	Installation	Outdoor (up right)
k)	Seismic acceleration	0.3 g horizontal
l)	Rated short time thermal current	31.5 kA for 1 sec.
m)	Number of terminals in marshalling box	All terminals of control circuits wired upto marshalling box plus 10 terminals spare.
n)	Rated extended primary current	120% of rated primary current of 960A

o)	Rated system voltage (Um)	72.5 kV (rms)
p)	Rated insulation levels-	
i	1.2/50 micro-sec. impulse	±325 kVp
ii	One minute power frequency withstand voltage	140 kV rms

### 7 Parameters for voltage transformers (66 kV CVTs)

a)	Rated frequency	50 Hz
b)	System neutral earthing	Effective earthed
c)	Installation	Outdoor
d)	Seismic acceleration	0.3 g horizontal
e)	System fault level	31.5 kA for 1 sec.
f)	Standard reference range of frequencies for which the accuracies are valid	96% to 102% for protection and 99% to 101% for measurement.
g)	High frequency capacitance for carrier frequency range	Within 80% to 150% of rated entire capacitance
h)	Equivalent resistance over entire carrier frequency range	Less than 40 ohms
i)	Stray capacitance and stray conductance of LV terminal over entire carrier frequency range	As per IEC:60358
j)	One minute power frequency withstand voltage -	
a)	Between LV (HF) terminal and earth	5 kV rms for exposed terminals or 2.5kV rms for terminals enclosed in a weather proof box.
b)	For secondary winding	2 kV rms
k)	Temp. rise over an ambient temp. of 50 deg. C	As per IEC 60186

l)	Number of terminals in control Cabinet	All terminals of control circuits wired upto marshalling box plus 5 terminals spare.
m)	Rated total burden	100 VA
n)	Partial discharge level	10 Pico Coulombs max.
o)	Number of cores	As per details given in table-II below.
p)	Rated system voltage	72.5 kV (rms)
q)	Rated insulation levels -	
i)	1.2 micro sec. impulse	±325 kV (peak)
ii)	One minute power frequency withstand voltage	140 kVp
r)	HF Capacitance	4400 pF (nominal)

The location of core shall be as per protection SLD.

## 8 Tests

The current and voltage transformers shall conform to type tests and shall be subjected to routine tests in accordance with the relevant IS/IEC and shall also conform to the following additional type tests :

- i) Switching impulse withstand test.
- ii) Thermal withstand test i.e. application of rated voltage and rated current simultaneously by synthetic test circuit.
- iii) Seismic withstand test along with structure.
- iv) Thermal co-efficient test i.e. measurement of Tan-Delta as function of temperature (at ambient and between 80 deg. C and 90 deg. C) and voltage (at 0.3, 0.7, 1.0 and 1.1 Um).
- v) In addition to routine tests as per IEC/IS, measurement of partial discharge in continuation with power frequency withstand test required for 66 kV current transformer.

**The type test reports shall not be older than FIVE years and shall be valid up to expiry of validity of offer.** The above additional lists if not conducted earlier, shall be done under the subject project package at no extra cost.

**9 Completeness of equipment:**

Any fittings, accessories or apparatus which may not have been specifically mentioned in this specification but which are usually necessary for the satisfactory operation of the equipment, shall be deemed to have been included in this specification.

**10 Packings:**

All material shall be suitably packed for transport, direct to site and Manufacturer shall be responsible for all damages/losses due to improper packing. All boxes shall be marked with signs indicating the up and down sides of the boxes along with the unpacking instructions, if considered necessary by the Manufacturers.

## **61. 66KV SURGE ARRESTORS**

### **1. General (for 11 kV, refer Tech specification Section 6, Part 2)**

The surge arrestors shall conform in general to IEC-60099-4 and IS:3070, Part-3 except to the extent modified in the specification and shall be in accordance with requirements under Part-I, shall be of ZnO gapless type.

Arrestors shall be hermetically sealed units, self-supporting construction, suitable for mounting on lattice type support structures.

### **2. Duty requirements**

The Surge Arresters (SAs) shall be capable of discharging over-voltages occurring due to switching of unloaded transformers and long lines.

The reference current of SAs shall be high enough to eliminate the influence of grading and stray capacitance on the measured reference voltage. Values and calculations shall be furnished with offer.

The SAs shall be fully stabilised thermally to give a life expectancy of thirty (30) years under site conditions and take care of effect of direct solar radiation.

The SAs shall be suitable for circuit breaker duty cycle in the given system.

The SAs shall protect power transformers, circuit breakers, disconnecting switches, instrument transformers, etc. with insulation levels specified in this specification. The Bidder shall carry out the insulation coordination studies for deciding the rating and application of the SAs.

The SAs shall be capable of withstanding meteorological and short circuit forces under site conditions.

### **3. Constructional features**

Each Surge Arrester (SA) shall be hermetically sealed single phase unit.

The nonlinear blocks shall be sintered metal oxide material. The SA construction shall be robust with excellent mechanical and electrical properties.

SAs shall have pressure relief devices and arc diverting ports suitable for preventing shattering of porcelain housing and to provide path for flow of rated fault currents in the event of SA failure.

The SA shall not fail due to porcelain contamination.

Seals shall be effectively maintained even when SA discharges rated lightning current.

Porcelain shall be so coordinated that external flashover will not occur due to application of any impulse or switching surge voltage upto maximum design value for SA.

The end fittings shall be non-magnetic and of corrosion proof material.

The Bidder shall furnish the following:

- a) V-I characteristics of the disc/block.
- b) Metalizing coating thickness for reduced resistance between adjacent discs along with procedure for checking the same.
- c) Details of thermal stability test for uniform distribution of current on individual discs.
- d) Detailed energy calculations to prove thermal capability of discs.

#### 4. Fittings and accessories

Each SA shall be complete with insulating base for mounting on structure.

SAs shall be provided with grading and/or corona rings as required.

Self-contained discharge counters, suitably enclosed for outdoor use (IP:55 degree of protection) and requiring no auxiliary or battery supply shall be fitted with each SA along with necessary connections to SA and earth. Suitable leakage current meters shall also be supplied in the same enclosure. The reading of milli-ammeter and counter shall be visible through an inspection glass panel to a man standing on ground. A pressure relief vent/suitable provision shall be made to prevent pressure build up.

#### 5. Parameters

##### 5.1 General

- |    |  |                                     |
|----|--|-------------------------------------|
| a) | System neutral earthing                                | - Effectively earthed               |
| b) | Installation   | - Outdoor                           |
| c) | Nominal discharge current                              | - 10 kA of 8/20 microsec. wave      |
| d) | Rated frequency  | - 50 Hz                             |
| e) | Long duration discharge class                          | - 3                                 |
| f) | Current for pressure relief test                       | - 31.5 kA rms                       |
| g) | Prospective symmetrical fault current                  | - 31.5 kA rms for 1 second          |
| h) | Low current long duration test value (2000 micro sec.) | - As per IEC                        |
| i) | Pressure relief class                                  | -Class A of Table VII of IS:3070 or |



equivalent IEC.

- |    |   |                           |
|----|---|---------------------------|
| j) | Partial discharge at 1.05 MCOV (Continuous operating voltage) | - Not more than 50 deg C. |
| k) | Siesmic acceleration  | - 0.3 g horizontal        |
| l) | Reference ambient temp.                                       | - 50 deg. C               |

### 5.2 66 kV Class Surge Arrestor

- |     |  |  |
|-----|--|--|
| a)  | Rated system voltage   | 66KV   |
| b)  | Rated arrestor voltage   | 60 KV  |
| c)  | Minimum discharge capability   | 8 kJ/kV or corresponding to minimum discharge characteristics given whichever is higher. |
| d)  | Continuous Operating Voltage (COV) at 50 deg. C                          | 49 kV rms  |
| e)  | Max. switching surge residual voltage (1 kA)                             | 165 kVp maximum  |
| f)  | Maximum residual voltage at  |  |
| i)  | 10kA nominal discharge current   | 180 kVp  |
| ii) | 20kA nominal discharge current   | As per IEC   |
| g)  | High current short duration test value (4/10 microsec. wave)             | 100 kVp  |
| h)  | Min. Total creepage distance   | 1850 mm  |
| i)  | One minute dry/wet power frequency withstand voltage of arrestor housing | 140 kV (rms)   |

- |    |  |                            |  |
|----|--|----------------------------|--|
| j) | Impulse withstand voltage of arrester Housing with 1.2/50 micro sec. wave. | $\pm 325$ kVp              |  |
| k) | RIV at 42 kV (rms)   | Less than 1000 micro volts |  |

**6. Completeness of equipment:**

Any fittings, accessories or apparatus which may not have been specifically mentioned in this specification but which are usually necessary for the satisfactory operation of the equipment, shall be deemed to have been included in this specification.

**7. Packings:**

All material shall be suitably packed for transport, direct to site and Manufacturer shall be responsible for all damages/losses due to improper packing. All boxes shall be marked with signs indicating the up and down sides of the boxes along with the unpacking instructions, if considered necessary by the Manufacturers.

## 62. 66 KV CABLE AND ACCESSORIES

### 1. Scope:

The scope under this section covers design, engineering, manufacture, testing, packing, supply of 66 KV, XLPE, insulated power cable for use with solidly grounded distribution systems. The XLPE cable and its accessories shall be complete with all fittings and components necessary for the satisfactory performance and ease of maintenance.

### 2. Standards:

Unless otherwise specified, the cables shall conform, in all respects, to IEC-502, IEC-60840 and IS: 7098 (Part-III) / 1993 with latest amendment or latest edition for cross linked polyethylene insulated Thermoplastic High Density Polyethylene sheathed cable for working voltage of 66 KV.

### 3. Climatic conditions:

The climatic conditions under which the cable shall operate satisfactorily are as follows:

- a) Maximum ambient temperature of air in shade  $^{\circ}\text{C}$  : 50
- b) Minimum ambient temperature of air in shade  $^{\circ}\text{C}$  : 4
- c) Maximum daily average ambient temperature  $^{\circ}\text{C}$  : 40
- d) Maximum yearly average ambient temperature  $^{\circ}\text{C}$  : 30
- e) Maximum relative humidity % : 95
- f) Max. soil temp. at cable depth  $^{\circ}\text{C}$  : 40
- g) Max. soil thermal resistivity ohm-cm : 100-120 Deg C  
cm/watt

### 4. Principal parameters:

**4.1** 66 KV (E) grade XLPE single core power cable of single length, with H.D. aluminium conductor, shielded with extruded semi-conducting layer, insulated with dry gas cured cross linked polyethylene (XLPE) insulation, insulation screened with extruded semi-conducting layer followed by semi-conducting non-woven water swellable tape, insulated core copper-wire, screened ( suitable for 31.5KA for 1 sec) tapped with a combination of semi-conducting water swellable and poly aluminium laminated followed by black extruded Thermoplastic HDPE (Poly-ethylene) inner sheath. Single H.D. aluminium wire armoured (suitable for 31.5KA for 1 sec) and graphite coating Thermoplastic HDPE outer sheathed overall cable, confirming to IEC-60840 for construction

and also confirming to IS : 7098 (Part-III) / 1993 or any latest amendments thereof.

**4.2** Outer sheathing should be designed to afford high degree of mechanical protection and should also be heat, oil chemicals and weather resistant. Common acid. Alkalis and saline solution should not have adverse effect on the Thermoplastic HDPE sheathing material used.

**4.3** The cable should be suitable for laying in covered trenches and / or underground for outdoor.

**4.4. Cable parameters 66 KV (to be customized by utility as per requirements and capacity)**

1	Voltage grade (Uo/U) KV	38/66
2	No. of cores	Single
3	Size (mm <sup>2</sup> )	630
4	Nominal system voltage KV	66
5	Highest system voltage KV	72.5
6	System Frequency Hz	50
7	Variation in frequency	± 5 %
8	Fault level individually for	
9	Conductor	59.22 KA / 1 Sec.
10	Cu.screen	31.5 KA / 1 Sec.
11	Armour	31.5 KA / 1 Sec.
12	Maximum allowable temperature, deg c	
13	a) Design continuous operation at rated full load current, the max. temp. of conductor shall not exceed(deg c)	90
14	b) The conductor temperature after a short circuit for 1.0 sec. shall not exceed (deg c)	250
15	Basic insulation level.	
16	(1.2 / 50 Micro second wave)	350 kVp
17	1-min. power frequency withstand voltage	140 kV

18 System earthing

Solidly grounded

## 5 General technical requirements:

**5.1 Conductor:** The cable conductor shall be made from stranded H.D. aluminium to form compact circular shaped conductor having resistance within limits specified in IS: 8130 / 1984 and any amendment thereof. The conductor shall conform to IEC: 228 and the shape shall be compacted circular shaped.

**5.2 Conductor shield:** The conductor having a semi-conducting screen shall ensure perfectly smooth profile and avoid stress concentration. The conductor screen shall be extruded in the same operation as the insulation; the semiconducting polymer shall be cross-linked.

**5.3 Insulation:** The XLPE insulation should be suitable for specified 66KV system voltage. The manufacturing process shall ensure that insulations shall be free from voids. The insulation shall withstand mechanical and thermal stressed under steady state and transient operating conditions. The extrusion method should give very smooth interface between semi-conducting screen and insulation. The insulation of the cable shall be of high standard quality, generally conforming to IEC-60840 and I.S. 7098 part-III / 1993 (latest edition).

**5.4 Insulation Shield:** To confine electrical field to the insulation, nonmagnetic semi-conducting shield shall be put over the insulation. The insulation shield shall be extruded in the same operation as the conductor shield and the insulation by triple extrusion process. The XLPE insulation shield should be bonded type. Metallic screening shall be provided. The metallic screen shall be of copper wire having fault current capacity (31.5 KA for 1-sec.)

**5.4 a)** A semi-conducting non-woven water blocking tape shall be provided over the extruded semi conducting layer and over the copper wire metallic screen.

**5.4b)** To avoid the ingress of moisture, poly-aluminium laminate tape shall be applied longitudinally with suitable overlap.

**5.5 Inner-Sheath:** The sheath shall be suitable to withstand the site conditions and the desired temperature. It should be of adequate thickness, consistent quality and free from all defects. The sheath shall be extruded and of black Thermoplastic H.D.P.E. (Poly-ethylene).

**5.6 Armour:** Single H.D. Aluminium wire armouring shall be provided. The dimension of H.D. Aluminium wire armouring shall be as per latest IS: 3975/19988. The armour shall be having fault current capacity (31.5 KA for 1-sec.)

**5.7 Outer Sheath:** Extruded Thermoplastic HDPE outer sheath conforming to IEC: 502/1983, shall be applied over armouring with suitable additives to

prevent attack by rodents and termites. The outer sheath shall be coated with graphite throughout the length of cable.

### **5.8 Construction:**

**5.8.1** All materials used in the manufacture of cable shall be new unused and of finest quality. All materials should comply with the applicable provision of the tests of the specification. IS, IEC, CEA regulations, Indian Electricity Act and any other applicable statutory provisions rules and regulations.

**5.9 Current Rating:** The cable will have current ratings and derating factors as per relevant standard IEC.

**5.9.1** The one-second short circuit current rating values each for conductor, screen & armour shall be furnished and shall be subject to the purchaser's approval.

**5.9.2** The current ratings shall be based on maximum conductor temperature of 90 deg. C with ambient site condition specified for continuous operation at the rated current.

### **5.10 Operation:**

**5.10.1** Cables shall be capable of satisfactory operation under a power supply system frequency variation of  $\pm 5\%$  voltage variation of  $\pm 10\%$  and combined frequency voltage variation shall be  $+10\%$  &  $-15\%$ .

**5.10.2** Cable shall be suitable for laying in ducts or buried under ground.

**5.10.3** Cable shall have heat and moisture resistance properties. These shall be of type and design with proven record on transmission network service.

**5.11 Identification Marking:** Identification of cables shall be 'provided externally at three meters' intervals to identify as under.

i) 'Name of manufacture'

ii) 'Per meter marking'

iii) 'Year of manufacture'

iv) 'Voltage grade' to be printed / embossed at the interval of one meter-length.

The identification, by printing or embossing shall be done only on the outer sheath. Name of the purchaser shall also be embossed.

**6.0 Tests: (refer Tech specification Section 6, Part -2).**

## 63. 66KV POST INSULATORS

### 1 General

The post insulators shall conform in general to latest IS:2544 and IEC-815.

### 2 Constructional Features

Post type insulators shall consist of a porcelain part permanently secured in a metal base to be mounted on the supporting structures. They shall be capable of being mounted upright. They shall be designed to withstand any shocks to which they may be subjected to by the operation of the associated equipment. Only solid core insulators shall be accepted. Height of post insulator shall be matched with the bus-bar and equipment line part elevation for required ground clearance.

The other requirements of insulator as given in technical specification of Auxiliary Items shall also be applicable.

### 3 Tests

3.1 In accordance with the stipulations under part-I the post insulators shall conform to type tests and acceptance, sample and routine tests as per IS:2544, IEC-168 shall be carried out.

3.2 In addition to acceptance/sample/routine tests as per IS:2544, IEC-168, the following tests shall also be carried out.

- a) Ultrasonic tests on all cut shells as routine check.
- b) Visual examination and magnaflux test on all flanges prior to fixing.
- c) Check for uniformity of thickness and weight of zinc coating as a sample test from each lot of flanges prior to fixing.
- d) Bending load test shall be carried out at 50% minimum failing load in four directions as a routine test.
- e) Bending load in four directions at 100% minimum bending load guaranteed on samples as per clause-2.3 of IEC. Subsequently this post insulator shall not be used.
- f) Tests for deflection measurement at 20, 50, 70% of specified minimum failing load on sample.

3.3 The post insulator shall conform to following type tests as applicable according to voltage class:

- a) Switching Impulse withstand test (dry & wet)
- b) Lightning Impulse withstand test (dry)
- c) Power frequency withstand test (dry & wet)
- d) Test for deflection under load.

e) Test for mechanical strength,

#### 4 Parameters

##### 66 kV Class Bus Post Insulator

a)	Type		Solid core type
b)	Voltage class (kV)		66 kV
c)	Dry and wet one minute power frequency withstand voltage (kV)		140 kV
d)	Dry impulse withstand positive and negative (kVp)		±325kv
e)	Max. radio interference voltage (pV) for any frequency between 0.5 MHz at voltage of 42 kV (rms) between phase to ground.		1000
f)	Total min. cantilever strength (Kg)		600
g)	Min. torsional moment (Kg m)		As per IEC-273
h)	Total height of insulator (mm)		As per Requirement
	i)	Top p.c.d. (mm)	127
	ii)	Bottom p.c.d. (mm)	127
i)	No. of bolts :	Top	4
		Bottom	8
j)	Diameter of bolt holes (mm)		
	Top		M16
	Bottom		Dia 18
k)	Pollution level as per IEC – 815		Class III, Heavy
l)	Min. total creepage distance (mm)		1850

#### 5 Completeness Of Equipment:

Any fittings, accessories or apparatus which may not have been specifically mentioned in this specification but which are usually necessary for the satisfactory operation of the equipment, shall be deemed to have been included in this specification.



**6 Packings:**

All material shall be suitably packed for transport, direct to site and Manufacturer shall be responsible for all damages/losses due to improper packing. All boxes shall be marked with signs indicating the up and down sides of the boxes along with the unpacking instructions, if considered necessary by the Manufacturers.

**1. Lighting**

(refer Section 6, Part -2 for specifications)

**2. LT Switchgear & DBS**

(refer Section 6, Part -2 for specifications)

**3. Battery & Battery Charger**

(refer Section 6, Part -2 for specifications)

## 64. Control & Protection System For 66kv Sub-Station

### 1 Preamble

This specification is based on the understanding that the bidder shall supply and commission a completely integrated System for 66 kV Sub-station as-

1. Substation control system.
2. Substation protection system

### 2 General Requirements Of Control System

1. The Simplex panel shall be vertical and freestanding, floor mounted type with swinging door at the back of the panel.
2. The height and width of the panel shall be as per standard practices.
3. One panel should accommodate two bay controlling facilities.
4. Each bay control shall comprise of,
  - a. One wattmeter, one voltmeter with selector switch and one ammeter with selector switch, one varmeter.
  - b. One control switch having LED type red and green indication for breaker control.
  - c. Red /green LED type indication lamp for isolator indication.
  - d. Semaphore indicator for earth switch.
  - e. One synchronizing switch with key and sockets.
  - f. The bay control panel for transformer shall also include cut out for one no RWTI.
5. Annunciator with window type display shall be provided on each control panel for alarm annunciation. The display shall be of standard size and shall accommodate minimum two alarms simultaneously. The annunciator shall have accept, reset and test facilities.
6. The panel shall have the required control wiring. The wire shall be 1.5sqmm copper per connection. For CT connection only 2.5sqmm size cable per connection shall be used.
7. Necessary space heater, lighting arrangements shall be provided.
8. Independent transducer shall be provided for varmeter and wattmeter. One extra output of 4-20ma shall be provided on the transducer for owner use. The accuracy of the transducer shall be 0.5%.
9. One of the panels should house the Check syn relay and Guard relay for synchronization. The synchronizing bus shall be of 2.5sqmm cable. The inter-panel wiring with necessary connection to check syn switch shall form the syn bus.

10. Bidder shall provide the syn scheme as per approval.

### **3 Panel Configuration**

As per Sub-Station requirement (to be specified by Employer)

### **4 General Requirements Of Relays**

- a. All relays and devices shall be of proven design and suitable make & type for the application satisfying the requirements specified elsewhere and shall be subject to the Employer's approval. Relays shall have appropriate setting ranges, accuracy, resetting ratio, transient overreach and other characteristics to provide the required sensitivity to the satisfaction of the Employer.
- b. Relays shall be suitable for efficient and reliable operation of the protection scheme. The necessary auxiliary relays, trip relays, etc. required for complete scheme, interlocking, alarm, logging, etc. shall be provided. No control relay, which shall trip the circuit breaker when the relay is de-energized, shall be employed in the circuits.
- c. Relays shall be provided with self-reset contacts except for the trip lockout, which shall have contacts with a manual reset feature.
- d. Suitable measures shall be provided to ensure that transients present in CT & VT connections due to extraneous sources in the EHV system do not cause damage to relays. CT saturation shall not cause mal-operation of relays.
- e. Only DC/DC converters shall be provided in solid state devices/relays wherever necessary to provide a stable auxiliary supply for relay operation.
- f. DC batteries in protective relays necessary for relay operation shall not be acceptable. Equipment shall be protected against voltage spikes in the auxiliary DC supply.
- g. The testing and commissioning protocols for the protection systems offered shall be approved by the Employer before commissioning on site.

### **5 EHV Line Protection**

Each 66 kV line shall be provided with the following protection:

- i) 3-zone non-switched static distance protection (21) proven for EHV D/C line protection application.
- ii) Non directional 3-ph over current (51)-(Definite Time).
- iii) Non directional earth fault (51N)- (Definite Time).
- iv) Autoreclosing relay.
- v) Check syn relay.

## **6 Bus Coupler Protection**

- i) Non directional 3 ph over current (51)
- ii) Non-directional delayed earth fault (51N)- (Definite Time).

## **7 66/11 kV Transformer Protections**

- i) Static Biased differential protection. (87T) with 2<sup>nd</sup> harmonic resistant with high set. Unit.
- ii) High Impedance LV REF. (64)
- iii) HV Directional over current (67/50/51)
- iv) LV Back up Earth Fault (51N)

## **8 66 kV Bus PT**

- i) Bus PT fuse failure relay.
- ii) 70% Bus under voltage relay.

## **9 Protection Philosophy**

- i) The 66kv line distance protection shall be set to cover the line length as per the parallel line distance protection philosophy.
- ii) The over current and earth fault relay provided on bus coupler and line shall be coordinated in such a way that for a bus fault on any of the bus the bus coupler shall open first. Then after some time delay the corresponding line shall be tripped. This time shall be less than zone-2 times setting of the remote end distance protection.
- iii) Fault between the 66/11 kV transformer and corresponding CT shall be cleared by the corresponding directional earth fault relay.
- iv) The distance relay offered by the bidder shall be suitable for 3-zone distance protection of 66kv and above line of length not more than 2 KM. The relay shall give reliable operation under all system contingencies. E/F element characteristics shall be reactive type to limit the mal operation and shall be reliable under high resistance fault.
- v) The distance relay located at the both end of transmission line shall operate independent of PLCC link.
- vi) The LBB trip command shall be extended to bus coupler and same bus breakers by appropriate isolators logic.

## **10 Auto-Reclose And Synchronizing Check**

Auto-reclose (AR) and Synchronizing Check (SC) functionality shall be provided in a separate device. The interfacing between S/S Controller and Protection Units for achieving the AR function logic shall be achieved at Bay Level using communication LAN as well as standby hard-wired logic. The AR function shall meet the following criteria:

- Be of single shot type
- Have three phase reclosing facilities. It shall have a user-selectable option of three phase or non-auto reclosure mode.
- Incorporate a normal/delayed auto reclosure option with a time range of 1 to 60 s.
- Have a continuously variable three-phase and single-phase dead time of 0,1 to 5 s.
- Have a continuously variable reclaim time of 5 to 300 s.
- Incorporate the necessary auxiliary relays and timers to provide a comprehensive reclosing and synchronizing scheme.
- Have facilities for selecting check synchronizing or dead line charging features. The user shall have an option to change the required feature.

The built-in Synchronization Check feature shall determine the difference between the amplitudes, phase angles and frequencies of two voltage vectors. Checks shall be provided to detect a dead line or bus bar. The voltage difference, phase angle difference and slip frequency settings shall be adjustable.

## **11 66 kV Circuit-Breaker Protection**

Each circuit breaker in the 66 kV bay shall be provided with following protection functions:

- i) Local Breaker Back up Protection Function: LBB protection function shall be provided for each circuit breaker in the 66 kV Sub-Station with following logic.
  - Be three pole type having three single phase units
  - Shall operate for stuck breaker conditions
  - Have an operating/resetting time each of less than 15 ms.

- The LBB function shall be initiated by external trip contacts from the Protection Units and after a set time delay shall energize the trip bus coupler.
- Have a setting range of 5 to 80% of rated current
- Have a continuous thermal withstand of 2 times rated current irrespective of the setting.
- Have time delay feature with a continuously adjustable setting range of 0,1 to 1 s.
- Shall be an individual phase comprehensive scheme.
- Shall not operate during the single-phase auto-reclosing period.

ii) Trip Coil Supervision: A Trip Coil supervision function shall be provided for each lockout trip relay and each of the circuit-breaker trip coils. It shall incorporate both the pre-close and post-close supervision of trip coils and associated trip circuits. An audible alarm shall be given in the event of operation of trip coil supervision function. It shall have a time delay on drop-off of not less than 200ms.

## 12 Energy Meters - Deleted

## 13 Panels

All panels shall be free standing, simplex type, floor mounting type and completely metal enclosed. Cable entries shall be from the bottom. Panels shall be of IP 31 class or better.

Panels shall have removable gland plates with glands made of brass and shall be suitable for armoured cables.

Panels shall be painted. The colour of paint for exterior of the panel shall be as follows:

Ends	Powder coated smoke grey to shade : 692 of IS-5 (Semi Gloss)
Front and Rear	-do-
Interior	White
Base	Black

## 14 Earthing

- a) The panels shall be equipped with an earth bus of at least 50x6mm<sup>2</sup> galvanized steel flat bar or equivalent copper.
- b) Earth buses of adjoining panels shall be connected for continuity. The continuous earth bus so formed shall be connected to the main earth grid at one end only.
- c) All metallic cases of the mounted equipment shall be separately connected to the earth bus by 2.5mm<sup>2</sup> copper wire. No loops in the earth wiring shall be permitted.
- d) CT/VT neutral secondary shall only be earthed at the terminal block of the panel through links, such that the earthing of one group may be removed without disturbing others.

## 15 Control Cabling Philosophy In Sub-Station

- a) Each secondary core of each phase CT/CVT shall be brought to the equipment marshalling box through independent cables.
- b) Each three phase secondary core of each CT/CVT shall be brought to the associated control/relay panel from the equipment marshalling box through independent cables.
- c) Single cores with at least 2.5mm<sup>2</sup> equivalent core cross-sectional area per connection shall be used for connection of all CT/CVT circuits.
- d) VT leads used for tariff metering shall have an equivalent core cross-sectional area of at least 2.5 mm<sup>2</sup> or equivalent per phase/neutral connection.
- e) Duplicate channels of protection shall have independent cables for tripping, DC supply, etc.
- f) For the following applications multiple cores with at least 2.5 mm<sup>2</sup> equivalent core cross - sectional area per connection shall be used:
  - i) DC supply to Bay Marshalling box
  - ii) DC supply to circuit-breaker cubicle
  - iii) DC looping for closing and tripping circuits of circuit-breaker
- g) Spare cores shall be provided as per following norms:

Up to 3-core cable	Nil
--------------------	-----

5 Core Cable	Min. 1 core
--------------	-------------

7 to 14 core cables	Min. 2 cores
More than 14 core	Min. 3 cores

h) For various field input from the breaker, transformer etc. for alarm, at least 1.5mm<sup>2</sup> equivalent cross section area per connection shall be used.

## **16 Factory Acceptance Tests (FAT)**

All equipment furnished under this specification shall be subject to test by authorized quality assurance personnel of the bidder and Employer's representatives during manufacture, erection and on completion. The approval of the Employer or passing such inspections or tests will not, however, prejudice the right of the Employer to reject the equipment if it does not comply with the specifications when erected or fails to give complete satisfaction in service. The detailed requirement of operational and pre-FAT tests as well as FAT test (Integrated Test) is given in this Section.

The FAT shall be mutually agreed upon and approved by Employer during detailed engineering.

## **17 Operational And Pre-FAT Tests**

a) The authorized quality assurance personnel of the manufacturer shall conduct all tests as per the requirements and fully satisfy themselves regarding completeness of hardware, software and full compliance with specification requirements by all equipment/sub-systems and the system as a whole before sending notification for FAT to the Employer. Bidder shall maintain accurate records for all pre-FAT tests which shall be properly documented and duly certified documents shall be furnished to Employer at least two weeks prior to FAT tests, while giving inspection call.

b) Each individual item of equipment/sub-system furnished by the Bidder as well as the complete system as per this specification shall be inspected and tested by the Bidder in his works for full compliance with specification requirements, completeness, proper assembly, proper operation, cleanliness and state of physical condition as applicable.



- c) The Bidder shall conduct a point by point wiring continuity check to every input and output and verify that the wiring connections agree with the documentation.
- d) The pre-FAT report shall be in the format of FAT procedure as approved by the Employer. It shall be accompanied by a very detailed report, in a log form, of the performance of all pre-FAT Tests. These records shall list not only the successfully completed tests, but shall detail all system, test and component failures.
- e) Bidder shall send notification regarding readiness for FAT and indicate the proposed date for commencement of FAT to enable the Employer to depute representatives for participating in these tests. The notification shall be sent to the Employer not less than one month prior to commencement of the FAT along with the copies of documents covering pre-FAT results.
- f) The Bidder shall ensure that all hardware required for fully implementing the system as per requirements of this specification is available and the adequacy of hardware, system configuration, etc., is fully established during the pre-FAT Tests conducted by the Bidder. In case any deficiencies in hardware is noticed by the Bidder during the pre-FAT Tests, the Bidder shall make good all such deficiencies and re-conduct the required tests to fully satisfy himself regarding completeness of the system and full compliance with specification requirements before sending notification to the Employer regarding FAT Tests.

## **18 Site / Commissioning Tests**

Site tests shall include all tests to be carried out at site upon receipt of equipment. It shall include but not be limited to testing calibration, configurations and pre-commissioning trials, startup tests, trial operation and performance and guarantee tests. The Bidder shall be responsible for all site / commissioning tests.

The Bidder shall maintain all tests, calibration records in Employer approved formats, and these shall be countersigned by authorized quality assurance personnel of the Bidder supervising these works.

The Bidder shall maintain master checklists to ensure that all tests and calibration for all equipment/devices furnished under these specifications are satisfactorily completed under the supervision of the authorized quality assurance personnel of the Bidder.

The site / commissioning tests shall be categorized under following categories:

- a) Startup tests
- b) Calibration and configuration checks
- c) Pre-commissioning tests
- d) Trial Operation

## e) Availability Tests

**19 Point-to-point testing shall include:**

Verification of all status indications by operating the plant

Verification of event / alarm indications by simulating alarm conditions

Verification of all analogue indications by injection testing.

Verification of control and protection logic.

**20 System Hand-over and Final Acceptance**

The system will be handed-over to the Employer for commercial operation after the site / commissioning tests have been completed to the satisfaction of the Employer. A hand-over certificate will be issued by the Employer. The Bidder will still be responsible for the Availability Tests.

Final acceptance of the system by the Employer will take place after the Availability Tests have been done to the satisfaction of the Employer.

**21 Type Test Requirements**

Test reports for following type tests shall be submitted for all relays.

**A. Insulation Tests:**

S.No.	Description	Standard
1	Dielectric Withstand Tests	IEC 60255-5 2 kV rms for 1 minute between all case terminals connected together and the case earth. 2 kV rms for 1 minute between all terminals of independent circuits with terminals on each independent circuit connected together. ANSI/IEEE C37.90-1989 1 kV rms for 1 minute across the open contacts of the watchdog relays. 1 kV rms for 1 minute across open contacts of changeover output relays. 1.5kV rms for 1 minute across open contacts of normally open output relays.

2	High Voltage Impulse Test, class III III	IEC 5 kV peak; 1.2/50 psec; 0.5 J; 3 positive and 3 negative shots at intervals of 5 sec	60255-5
---	--	--	---------

### B. Electrical Environment Tests:

1	DC Supply Interruption	IEC 60255-11 The unit will withstand a 20ms interruption in the auxiliary supply, in its quiescent state, without de-energizing.	
2	AC Ripple on DC supply	IEC The unit will withstand a 12% ac ripple on the dc supply.	60255-11
3	AC voltage dips and short Interruptions	IEC 20ms interruptions/dips.	61000-4-11
4	High Frequency Disturbance	IEC At 1MHz, for 2s with 200 ohms source impedance: 2.5 kV peak; 1 MHz; T = 15 psec; 400 shots/sec; duration 2 sec between independent circuits and independent circuits and case earth. 1.0kV peak across terminals of the same circuit.	60255-22-1, class III
5	Fast Transient Disturbance	IEC 4kV, 2.5kHz applied directly to auxiliary supply 4kV, 2.5kHz applied to all inputs.	60255-22-4, class IV
6	Surge Withstand Capability	IEEE/ANSI C37.90.1 (1989) 4kV fast transient and 2.5kV oscillatory applied directly across each output contact, optically isolated input and power supply circuit	
7	Radiated Immunity	C37.90.2: 25MHz to 1000MHz, zero and 100% square wave modulated. Field strength of 35V/m.	1995
8	Electrostatic Discharge	IEC 15kV discharge in air to user interface, display and exposed metal work. IEC 8kV discharge in air to all communication ports. 6kV point contact discharge to any part of the front of the product.	60255-22-2 Class 4 60255-22-2 Class 3

9	Surge Immunity	IEC 61000-4-5: 1995	Level 4
		4kV peak, 1.2/50ms between all groups and case earth. 2kV peak, 1.2/50ms between terminals of each group.	
10	Capacitor Discharge	No change of state or any operation shall occur when a capacitor of capacitance shown below, charged to $1.5 \times V_n$ volts, is connected between any combination of terminals and any combination of terminals and ground. Master trip circuits – 10pF Other protection & control circuits – 2pF	

### C. EMC Tests:

Sl. No.	Description	Standard
1	Radio-Frequency Electromagnetic Field, Non-Modulated	IEC 60255-22-2, class III 10 V/m; 27 MHz to 500 MHz
2	Radio-Frequency Electromagnetic Field, Amplitude Modulated	ENV 50140, class III 10 V/m; 80 MHz to 1000 MHz; 80% AM; 1 kHz
3	Radio-Frequency Electromagnetic Field, Pulse Modulated	ENV 50140/ENV 50204 10 V/m; 900 MHz; repetition frequency 200 Hz; duty cycle 50 %
4	Disturbances Induced by Radio Frequency fields, Amplitude Modulated	ENV 50141, class III
5	Power Frequency Magnetic Field	EN 61000-4-8, class IV 30 A/m continuous; 300 A/m for 3 sec; 50Hz
6	Interference Voltage, Aux.	EN 50081-*

	Voltage	150 kHz to 30 MHz	
7	Interference Field Strength	EN 30 MHz to 1000 MHz	50081-*

#### D. Atmospheric Environment Tests:

Sl. No.	Description	Standard
1	Temperature	IEC 60255-6 Operating -40C to +550C Storage and transit -40C to +700C IEC 60068-2-1 for Cold IEC 60068-2-2 for Dry heat
2	Humidity	IEC 60068-2-3 56 days at 93% RH and +400C

#### E. Mechanical Stress Tests:

Sl. No.	Description	Standard
1	Vibration (during Operation and Transportation)	IEC 255-21-1; IEC 68-2-6 Response Class 2 Endurance Class 2
2	Shock (during Operation and Transportation)	IEC 255-21-2, class 1, IEC 68-2-27 Shock response Class 2 Shock withstand Class 1 Bump Class 1
3	Seismic Vibration (during Operation)	IEC 60255-21-3 Class 2

- 4            Continuous            IEC 255-21-2, class 1, IEC 68-2-27  
Shock (during  
Transportation)

## **22    Settings**

Fault levels will be provided to the Bidder by the Employer. The Bidder shall, based on this information, compile a complete and detailed report for the setting of the protection elements on all the protection equipment, to the approval of the Employer. Any additional information required to complete this exercise shall be timeously requested by the Bidder.

The bidder shall provide the Employer with a philosophy document clearly setting out the philosophy the bidder will use in determining setting levels. Each setting will have a brief description of the specific function or element. The setting calculation and formula will also be shown on the document. All relevant system parameters, line data, transformer data additionally used for calculating the setting will appear in the setting document. The bidder will conduct system studies in determining fault levels on different locations. These study results will also form part of the setting document. Any additional information required to complete this exercise shall be timeously requested by the Bidder.

The setting document will be presented and discussed with the Employer prior to final issue of the document. The final accepted setting document should be made available to the Employer in PDF format.

It is the Bidder's responsibility to configure each protection relay to provide the protection and control facilities required. A full set of relay configuration and setting files shall be included in the design and documentation submissions. The bidder will issue three sets of setting documents once accepted by the client and consultant.

## **23    Completeness Of Equipment:**

Any fittings, accessories or apparatus which may not have been specifically mentioned in this specification but which are usually necessary for the satisfactory operation of the equipment, shall be deemed to have been included in this specification.

## **24    Packings:**

All material shall be suitably packed for transport, direct to site and Manufacturer shall be responsible for all damages/losses due to improper packing. All boxes shall be marked with signs indicating the up and down sides

of the boxes along with the unpacking instructions, if considered necessary by the Manufacturers.

## 65. SWITCHYARD AUXILIARY ITEMS

### 1. ACSR Conductor

a)	Code and standard	IS 398 (Part-II)
b)	Name	ACSR Equivalent to 261.5 sq.mm. area conductor/Panther
c)	Overall diameter	21.00 mm
d)	Weight	974 kg/km
e)	Ultimate tensile strength	89.67 kN minimum
f)	Strands and wire diameter of	
	Aluminium	30/3.00 mm
	Steel	7/3.00 mm

### 2. Clamps And Connectors

2.1 The material of clamps and connectors shall be Aluminium alloy casting conforming to designation A6 of IS:617 for connecting to equipment terminals and conductors of aluminium. In case the terminals are of copper, the same clamps/connectors shall be used with 2mm thick bimetallic liner.

2.2 The material of clamps and connectors shall be Galvanised mild steel for connecting to shield wire.

2.3 Bolts, nuts and plain washers shall be hot dip galvanised mild steel for sizes M12 and above. For sizes below M12, they shall be electro-galvanised mild steel. The spring washers shall be electro-galvanised mild steel.

2.4 All castings shall be free from blow holes, surface blisters, cracks and cavities. All sharp edges and corners shall be rounded off to meet specified corona and radio interference requirements.

2.5 They shall have same current rating as that of the connected equipment. All current carrying parts shall be at least 10 mm thick. The connectors shall be manufactured to have minimum contact resistance.

2.6 Flexible connectors, braids or laminated strips shall be made up of copper/aluminium.



2.7 Current rating and size of terminal/conductor for which connector is suitable shall be embossed/punched on each component.

### 3. Insulator String Hardware

3.1 The insulator hardware shall be of bolted type and shall be of forged steel except for insulator cap, which can be of malleable cast iron. It shall also generally meet the requirements of clamps and connectors as specified above.

3.2 In one span, Tension string assembly at one end shall be supplied with suitable turn buckle.

### 3.3 Disc Insulator

The disc insulator shall meet the following parameters:

Type	Antifog type insulator
Size of insulator	255x145
Electro mechanical strength	120kN
Leakage distance (mm)	430mm minimum or as required to meet the total creepage.
Power frequency withstand voltage	85 kV (dry), 50kV (wet)

### 4. Earthing Conductor

4.1 The main conductor buried in earth shall be 40mm dia rod for main and auxiliary mat. The earthing conductors over the ground shall be of 75x12 mm GS flat. The earthing leads for columns and auxiliary structures, cable trenches shall be of 75x12 mm GS flat. The earthing of the lighting fixtures shall be carried out by 16 SWG wire.

4.2 All conductors above the ground level shall be galvanised steel.

### 4.3 Earthwire for Lightning Protection

a)	Number of strands	7 of steel
b)	Strand diameter	3.15 mm
c)	Overall diameter	9.45 mm
d)	Weight	431.80 kg/km approx.
e)	Ultimate tensile strength	68.4 kN minimum
f)	Total cross-sectional area	54.55 sq.mm.
g)	Calculated DC resistance	3.375 ohms/km at 20 deg. C.
h)	Direction of lay of outer layer	Right hand
i)	Protective coating for storage	Boiled linseed oil to avoid wet storage stains (white rust)

#### **4.4 Cable Support Structures & Accessories**

4.4.1 The Bidder shall fabricate and install mounting arrangements for the support and installation of all the cables on angles in trenches. These mounting structures/cable racks shall be fabricated from structural steel members (channels, angles and flats) of the required size.

4.4.2 Cable supports shall be painted after installation. The painting shall be in conformity with stipulated in **Section 6, Part -2**. All welding works inclusive of the consumables required for fabrication and installation shall be in the scope of the Bidder.

#### **5. Bushings, Hollow Column Insulators, Support Insulators, And Disc Insulators**

5.1 Bushings shall be manufactured and tested in accordance with IS:2099 & IEC:137 while hollow column insulators shall be manufactured and tested in accordance with IEC 233/IS 5284. The support insulators shall be manufactured and tested as per IS:2544/IEC 168/IEC 273. The insulators shall also conform to IEC 815 as applicable.

5.2 Support insulators/bushings/hollow column insulators shall be designed to have ample insulation, mechanical strength and rigidity for the conditions under which they will be used.

5.3 Porcelain used shall be homogenous, free from laminations, cavities and other flaws or imperfections that might affect the mechanical or dielectric quality and shall be thoroughly vitrified, tough and impervious to moisture. Hollow porcelain should be in one integral piece in green & fired stage.

5.4 Glazing of the porcelain shall be uniform brown in colour, free from blisters, burns and other similar defects.

5.5 When operating at normal rated voltage there shall be no electric discharge between conductor and insulators which would cause corrosion or injury to conductors or when operating at normal rated voltage.

5.6 The design of the insulator shall be such that stresses due to expansion and contraction in any part of the insulator shall be lead to deterioration. All ferrous parts shall be hot dip galvanised.

5.7 Bidder shall make available data on all the essential features of design including the method of assembly of shells and metal parts, number of shells per insulator, the manner in which mechanical stresses are transmitted through shells to adjacent parts, provision for meeting expansion stresses, results of corona and thermal shock tests, recommended working strength and any special design or arrangement employed to increase life under service conditions.

5.8 Post type insulators shall consist of a porcelain part permanently secured in metal base to be mounted on supporting structures. They shall be capable of being mounted upright. They shall be designed to withstand all shocks to which they may be subjected to during operation of the associated equipment.

5.9 Bushing porcelain shall be robust and capable of withstanding the internal pressures likely to occur in service. The design and location of clamps, the shape and the strength of the porcelain flange securing the bushing to the tank shall be such that there is no risk of fracture. All portions of the assembled porcelain enclosures and supports other than gaskets, which may in any way be exposed to the atmosphere shall be composed of completely non hygroscopic material such as metal or glazed porcelain.

5.10 All iron parts shall be hot dip galvanised and all joints shall be air tight. Surface of joints shall be trued, porcelain parts by grinding and metal parts by machining. Insulator/ bushing design shall be such as to ensure a uniform compressive pressure on the joints.

5.11 Bushings, hollow column insulators and support insulators shall conform to type tests and shall be subjected to routine tests and acceptance test/ sample test in accordance with relevant standards.

5.12 Insulator shall meet requirement of IEC - 815 as applicable, having alternate long & short sheds.

## **6. Cabinets, Boxes, Kiosks And Panels, Etc.**

6.1 All types of control cabinets, junction boxes, marshaling boxes, lighting panels, terminal boxes, operating mechanism boxes, etc. shall generally conform to IS:5039, IS:8623 and IEC:439 as applicable.

6.2 They shall be of painted sheet steel or aluminium. The thickness of sheet steel shall be 2mm cold rolled or 2.5mm hot rolled. The thickness of aluminium shall be 3mm and shall provide rigidity. Top of the boxes shall be sloped towards rear of the box. The paint shall be of grey RAL 9002 on the outside and glossy white inside. However, the junction and switch boxes shall be of hot dip galvanised sheet steel of 1.6mm thickness.

6.3 The cabinets/boxes/kiosks/panels shall be free standing or wall mounting or pedestal mounting type. They shall have hinged doors with padlocking arrangement. All doors, removable covers and plates shall be gasketed all around with neoprene gaskets.

6.4 The degree of protection of all the outdoor boxes shall not be less than IP 55 as per IS 2147.

6.5 The cable entry shall be from bottom, for which removable gasketed cable gland plates shall be provided.

6.6 Suitable 240V, single phase, 50Hz ac heaters with thermostats controlled by switch and fuse shall be provided to maintain inside temperature 10deg. above the ambient.

6.7 The size of enclosure and the layout of equipment inside shall provide generous clearances. Each cabinet/box/kiosk/panel shall be provided with a 15A, 240V ac, 2 pole, 3 pin industrial grade receptacle with switch. For incoming supply, MCB of suitable rating shall be provided. Illumination of each compartment shall be with door operated incandescent lamp. All control switches shall be of rotary switch type.

6.8 Each cabinet/box/kiosk/panel shall be provided with two earthing pads to receive 75mmx12mm GS flat. The connection shall be bolted type with two bolts per pad. The hinged door shall be connected to body using flexible wire. The cabinets / boxes / kiosks / panels shall also be provided with danger plate, and internal wiring diagram pasted on inside of the door. The front label shall be on a 3mm thick plastic plate with white letters engraved on black background.

## **7. Bay Marshalling Box**

7.1 Three no. bay MBs shall be provided located at a convenient location to receive and distribute cables one marshalling box should be used for requirement of two bays. It shall meet all the requirements as specified for cabinets/boxes above.

7.2 It shall have three separate distinct compartments for following purposes:

- To receive two incoming 415V, three phase, AC supplies controlled by 25A four pole MCBs, and to distribute five (5) three phase ac supplies controlled by 8A four pole MCBs.
- 80 nos. terminal blocks in vertical formation for interlocking facility.

### **8. Terminal Blocks**

8.1 They shall be non-disconnecting stud type of extensible design equivalent to Elmex type CAT-M4.

8.2 The terminal blocks shall be of 650V grade, and rated to continuously carry maximum expected current. The conducting part shall be tinned or silver plated.

8.3 The terminals shall be provided with marking tags for wiring identification.

8.4 The terminal blocks for CT and VT secondary leads shall be provided with test links and isolating facilities. CT secondary leads shall also be provided with short circuiting and earthing facilities.

### **9. Wiring**

9.1 All wiring shall be carried out with 1100 V grade stranded copper wires. The minimum size of the stranded conductor used for internal wiring shall be as follows :

Wherever the cable size is specified that has to be used, otherwise,

- a. All circuits except PT/CT circuits 1.5 sq.mm
- b. PT/CT circuits 2.5 sq. mm.

9.2 All internal wiring shall be securely supported, neatly arranged readily accessible and connected to equipment terminals and terminal blocks.

9.3 Wire terminations shall be made with solderless crimping type of tinned copper lugs which firmly grip the conductor and insulation. Insulated sleeves shall be provided at all the wire terminations. Engraved core identification plastic ferrules marked to correspond with the wiring diagram shall be fitted at both ends of each wire. Ferrules shall fit tightly on the wires shall not fall off when the wires and shall not fall off when the wire is disconnected from terminal blocks.

9.4 All wires directly connected to trip circuit breaker shall be distinguished by the addition of a red coloured unlettered ferrule. Number 6 & 9 shall not be included for ferrules purposes.

9.5 All terminals including spare terminals of auxiliary equipment shall be wired upto terminal blocks. Each equipment shall have its own central control cabinet in which all contacts including spare contacts from all poles shall be wired out. Interpole cabling for all equipment's shall be carried out by the Bidder.

## **10. Cable Glands And Lugs**

10.1 Cable glands shall be Double compression type, tinned/Nicked plated (coating thickness not less than 20 microns in case of tin and 10 to 15 microns in case of nickel) brass cable glands for all power and control cables. They shall provide dust and weather proof terminations. They shall comprise of heavy duty brass casting, machine finished and tinned to avoid corrosion and oxidation. Rubber components used in cable glands shall be neoprene and off tested quality. Required number of packing glands to close unused openings in gland plates shall also be provided.

10.2 The cable glands shall be tested as per BS:6121. The cable glands shall also be duly tested for dust proof and weather proof termination.

10.3 Cables lugs shall be tinned copper solder less crimping type conforming to IS:8309 and 8394 suitable for aluminum or copper conductor (as applicable). The cable lugs shall suit the type of terminals provided. The cable lugs shall be of Dowell make or equivalent.

## **11. Conduits, Pipes And Accessories**

11.1 The Bidder shall supply and install all rigid conduits, mild steel pipes, flexible conduits, hume pipes, etc. including all necessary sundry materials, such as tees, elbows, check nuts, bushing reduces, enlargers, wooden plugs, coupling caps, nipples, gland sealing fittings, pull boxes, etc.

11.2 Rigid conduits shall be flow-coat metal conduits of Nagarjuna Coated Tubes or equivalent make. The outer surface of the conduits shall be coated with hot-dip zinc and chromate conversion coatings. The inner surface shall have silicone epoxy ester coating for easy cable pulling. Mild steel pipes shall be hot-dip galvanised. All rigid conduits/ pipes shall be of a reputed make.

11.3 Flexible conduits shall be heat-resistant lead coated steel, water-leak, fire and rust proof, and be of PLICA make or equivalent.

## **12. Auxiliary Switch**

The auxiliary switch shall conform of following type tests:

- a)Electrical endurance test - A minimum of 1000 operations for 2A. D.C. with a time constant greater than or equal to 20 milliseconds with a subsequent examination of mV drop/visual defects/temperature rise test.
- b)Mechanical endurance test - A minimum of 5000 operations with a subsequent checking of contact pressure test/visual examination
- c)Heat run test on contacts
- d)IR/HV test, etc.

## **13. Type Tests**

All equipment with their terminal connectors, control cabinets, main protective relays, etc. as well as insulators, insulator strings with hardwares, clamps and connectors, marshalling boxes, etc., shall conform to type tests and shall be subjected to routine and acceptance tests in accordance with the requirements stipulated under respective equipment sections.

## **14. Completeness Of Equipment:**

Any fittings, accessories or apparatus which may not have been specifically mentioned in this specification but which are usually necessary for the satisfactory operation of the equipment, shall be deemed to have been included in this specification.

## **15. Packings:**

All material shall be suitably packed for transport, direct to site and Manufacturer shall be responsible for all damages/losses due to improper packing. All boxes shall be marked with signs indicating the up and down sides of the boxes along with the unpacking instructions, if considered necessary by the Manufacturers.



## 66. 11 KV SWITCHGEAR

### 1. General

This section of specification covers the design, manufacture, assembly, shop testing/inspection before dispatch, packing, forwarding, transportation to site, insurance (during transit, storage and erection), storage, erection, supervision, site testing and commissioning of 11 kV, 3 phase 50 Hz air insulated metal clad indoor switchgear unit with horizontal draw out circuit breaker at 66/11 kV Substation.

The scope of supply shall also include necessary special tools and plants required for erection, maintenance.

The switchgear panel should be complete in all respects with insulators, bimetallic connectors, interrupting chamber (vacuum circuit breaker), operating mechanisms control cabinet, interlocks, auxiliary switches indicating devices, supporting structures, accessories, etc., described herein and briefly listed in the schedule of requirements. The spares/attachments which are necessary for the smooth functioning of the equipment and specifically are not mentioned here shall be assumed to be included the scope of supply.

### 2. Standards

2.1 The circuit Breaker shall conform to the latest revision with amendment available of relevant standards, rules, and code. Some of which are listed herein for ready reference.

Sl. No.	IS	IEC	Item
1	IS-13118 (1991)	IEC-56	Specification of High Voltage AC Circuit Breaker
	IS-12729	IEC-694	Common clauses for high voltages switchgear and control control gear standards
2	IS-2705 (1992)		Current Transformer
3	IS-3156 (1992)		Voltage Transformer
4	IS-3231 (1987)		Relays
5	IS-1248		Ammeter & Voltmeter

6	IS-375		Arrangement of Breaker Busbars main connection and auxiliary wiring
7	CBIP REPORT NO.-88 (JULY) 1996	IEC-687	Static Energy Meter
8	IS-3072		Installation and maintenance of switchgear
9	IS : 9135		Guide for testing of circuit breakers with respect to out of phase switching
10		IEC : 60	High voltage testing technique
11	IEC-17A Study Group Dec. 1981		Sealing of interrupters/breakers
12	IS-3427		Metal enclosed Switchgear and Control gear
13	IS-1554	IEC-227	PVC insulated cables upto and including 1000 volts
14	IS : 5		Colors for ready mixed paints and enamels
15		IEC : 529	Degree of protection
16	IS : 996	IEC-34	Single phase Small AC and universal electrical motors
17	IS : 2629, 2633	Iso : 1460	Hot dip galvanising

2.2 Equipment conforming to other international standards will also be considered if they ensure performance and constructional feature equivalent or superior to the standard listed above. Bidder shall clearly indicate the standard as adopted.

### **3. Service Conditions**

#### **3.1 Climatic Conditions**

The breakers and accessories to be supplied against this specification shall be suitable for satisfactory continuous operation under the tropical conditions.

#### 4. Configurations of different type of panels (to be customized by utility as per capacity and requirement)

TYPE	RATING	NO.
Incomer	1600A	2
Bus Coupler	1600A	1
Bus PT	$11000/\sqrt{3}/110/\sqrt{3}$	2
11 kV Feeder		
• CAPACITOR FEEDER	800A, SUITABLE FOR 2500 KVAR CAPACITOR CHARGING DUTY.	4
• NORMAL FEEDER	800A	12

#### 5. Construction

5.1 The 11 kV HT Switch board shall be totally enclosed dust and vermin proof, sheet metal clad, floor mounted, free standing, indoor type and shall house circuit breakers, busbars, control equipments, cable termination, current transformers, potential transformers, instruments, relays and other accessories. All HT panels shall be with fully draw out type breaker carriages, compartmentalized design with cold rolled sheet steel (thickness 2.0 mm for non load bearing and 3.0mm for load bearing parts) and with IP-4X class of enclosure. The Circuit Breaker compartment, Busbar compartment, Cable compartment and LT compartment shall have its own pressure relief flaps/vents with a view to release pressure which would develop in the unlikely event of fault. The vents shall not allow entry of vermin in any case. Bus bar, metering, circuit breaker chamber, cables and cable box chamber should have proper access for maintenance, proper interlocks should be provided. All instruments shall be non-draw out type and safe guard in every respect from damages and provided with mechanical indicator of connection and disconnection position. The switchgear shall be completed with all necessary wiring fuses, auxiliary contacts terminal boards etc.

5.2 For each of the incoming and outgoing cubicles, the cable connection, HT bus bars and all low voltage control devices shall be housed in separate

enclosures. These enclosures shall be necessarily isolated from that for main circuit breaker chamber to offer better safety and protection of working personnel. All doors other than cable chamber shall be of hinged and lockable type with Neoprene gaskets at all joints and the cable chamber shall be fixed with nuts and bolts. Additional wire mesh guards and gaskets shall be provided for cable chamber.

5.3 The arcing contacts and bus bar should be rated for 25ka for 1s Bus bars shall be capable of connecting one switchgear panel to other through proper insulated arrangement, which does not decrease the insulation strength of the bus bar at the point of connection between two panels. The panels shall be modular in design.

5.4 The breakers should be able to be drawn out in horizontal position at ground level [with vertical/horizontal isolation] when breaker is drawn out in horizontal position none of the live components inside the 11 KV switchgear panel should be accessible. The safety shutters shall be robust and shall automatically cover the live components when the breaker is drawn out. The switchgear shall have complete interlocking arrangements at the fully inserted and fully drawn out and test positions. Withdrawal of the breaker should not be possible in ON position, it should not be possible to close the circuit breaker in service unless the entire auxiliary and control circuit are connected.

5.5 Breaker should have three distinct positions inside the cubical; i.e. service, test and isolated.

5.6 The switchboard shall be suitable to handle full rated capacity in the naturally ventilated atmosphere and it shall be able to control and contain the high short circuit energy under internal arc conditions and ensure safety of the operating personnel in case of faults.

5.7 The cubicle door can be fully shut with breaker in 'ISOLATED' position to stop ingress of dust and vermin. All switching operations shall be performed with the door closed.

5.8 The VT/Relay compartments shall have degree of protective not less than IP52 in accordance with IS:13947. However remaining compartments can have IP 4X type sealing. All louvers if provided shall have very fine Brass or GI mesh screen.

5.9 Safety shutters complying with IEC-60298 shall be provided to cover up the fixed high voltage contacts on busbar and cable sides when the truck is moved to ISOLATED position. The shutters shall move automatically, through a linkage with the movement of the truck. Preferably it shall however, be possible to open the shutters of busbar side and cable side individually against spring pressure for testing purpose after defeating the interlock with truck movement deliberately. It shall also be possible to padlock shutters individually. In case, insulating shutters are provided, these shall meet the requirements of Clause 3.102.1 Note –2 of IEC-60298 and necessary tests are per IEC –60298 Clause 5.103.1 shall be carried out. A clearly visible warning label “Isolate elsewhere before earthing” shall be provided on the shutters of incoming and tie connections which could be energized from other end.

5.10 The switchboard shall have the facility of extension on both sides. Adopter panels and dummy panels required to meet the various busbar arrangement, cable / busduct termination and layouts shall be included in Bidder's scope of work.

5.11 Bus duct inter connection is also includes in the Bidder Scope of Work. The interconnection shall be top entry type with required enclosure and bus duct site. Adequate support shall be provided for this inter-connection by higher from roof.

## **6. Bus bars and connectors and insulators**

6.1 Bus bars and all other electrical connection between various components shall be made of high conductive aluminum alloy of rectangular cross sections. The bus bars shall be able to carry the rated current of 1600 Amp continuously without excessive heating and for adequately meeting the thermal and dynamic stresses in the case of short circuit in the system up to full SC rating specified.

6.2 All bus bars connections shall be firmly and rigidly mounted on suitable insulators to withstand short circuit stresses and vibrations.

6.3 Adequate clearance between 11 KV point and earth and between phases shall be provided to ensure safety as per provision in the relevant Indian standard specification/CEA regulations and the same shall be capable of withstanding the specified high voltage tests as per IS-13118/IEC-56 and amendment thereof.

6.4 Sharp edges and bends either in the bus bars or bus bar connections shall be avoided as far as possible. Wherever such bends or edges are un-avoidable, suitable compound or any other insulation shall be supplied to prevent local ionization and consequent flashover.

6.5 Busbar cross-section shall be uniform throughout the length of switchgear. Busbars and other high voltage connection shall be sufficiently corona free at maximum working voltage.

Busbar insulators shall be of arc and track resistant high strength, non-hygroscopic, non-combustible type and shall be suitable to withstand stresses due to over-voltages, and short circuit current. Busbar shall be supported on the insulators such that the conductor expansion and contraction are allowed without straining the insulators. In case of organic insulator partial discharge shall be limited to 100 pico coulomb at rated capacity.

## **7. Circuit breaker**

7.1 HT circuit breakers envisaged in the specification shall be designed to control and protect the power system. The circuit breaker shall conform to IS 13118: 1991, IS 3427: 1969, IEC 298, IEC : 694 and IEC publication 56.

7.2 All circuit breakers shall be of horizontal isolation & horizontal draw out type construction having easy manufacturing facility with separate lockable doors over their compartment. The circuit breakers shall be fitted with necessary safety mechanical interlocks.

7.3 The moving carriage of circuit breaker shall be provided with earthing contacts continuously so that the breaker remains positively earthed in "service" position and during withdrawal operation up to "test" position. The breaker shall have anti pumping features.

7.4 All circuit breakers shall have three operational positions such as "Service", "Test" and "Isolated" position with positive indication for each position. All circuit breakers of identical rating shall be physically & electrically interchangeable.

7.5 The HT breaker shall be provided with motor operated, spring charged independent closing mechanism. The mechanism shall have one geared motor which will automatically recharge the mechanism as soon as breaker is closed. These breakers shall have electrical and mechanical trip free features and an

emergency mechanical push to trip the same. All the features of the equipment shall ensure complete safety of the operation and shall be complete with approved safety devices to protect against potential hazards to operating personnel or to the equipment around. The breakers shall also have facilities for manual operation during emergency and servicing. Mechanism shall be simple, rugged and reliable with minimum number of linkages. No damage to parts shall take place in case of any inadvertent attempt for wrong operation.

7.6 All HT breakers shall be provided with at least 8 potential free Aux. contacts to be used for interlocking / signaling purposes. Contact arrangement may be 4 NO + 4 NC and these shall be rated for 220 VDC, 6 Amp.

7.7 The circuit breakers shall be capable of rapid & smooth interruption of current under all conditions completely suppressing all undesirable phenomenon even under most severe & persistent short circuit condition or when interrupting small leading or lagging reactive current.

7.8 The circuit breaker and panel should be completely type tested for 25 KA for 1 sec. and Test Certificate from independent authority should be submitted along with the Tender.

7.9 Facilities to check contact erosion shall be provided particularly.

7.10 Comprehensive interlocking system to prevent any dangerous or inadvertent operation shall be provided. Isolation of circuit breaker from bus bar or insertion into bus bar shall only be possible when the breaker is in the open position.

7.11 Vacuum interrupter should have an expected life of 30000 operations at rated current and should be capable for operating more than 100 times at rated short circuit current.

7.12 The switchgear should be designed for 2500 KVAR charging duty.

7.13 Mechanical indicators shall be provided on the breaker trucks to indicate OPEN / CLOSED conditions of the circuit breaker, and CHARGED/DISCHARGED conditions of the closing spring. An operation counter shall also be provided. These may be visible without opening the breaker compartment door.

## 8. Control and Interlocks

The circuit breaker will normally be controlled from local panels through closing and trip coils.

Facilities shall be provided for mechanical tripping of the breaker and for manual charging of the stored energy mechanism for a complete duty cycle, in an emergency. These facilities shall be accessible only after opening the compartment door.

Each panel shall have two separate limit switches, one for the Service position and the other for Isolated position. Each of these limit switches shall have at least four (4) contacts which shall close in the respective positions.

Auxiliary Contacts of breaker / contactor may be mounted in the fixed portion or in the withdrawable truck as per the standard practice of the manufacturer, and shall be directly operated by the breaker / contactor operating mechanism.

Circuit breaker shall be provided with inter pole barriers of insulating materials. The use of inflammable materials like Hylam shall not be acceptable.

## 9. Protection relays

9.1 All the switchgears shall be provided with protective relays designed to disconnect faulty circuit with speed and discrimination and shall conform to IS-3231 (1987) or latest revision thereof regarding accuracy and other feature. Composite relay unit having S/C, O/C, E/F etc. shall be preferred.

9.2 All protective & auxiliary relays shall be in dust & vermin proof enclosure, flush mounted on front side of metering compartment and shall be draw out type.

9.3 Insulation of relays should withstand 2.5 KV AC (rms) at 50 Hz for one second between all circuits and the case and between all circuits not intended to be connected together as per IS – 3231 : 1965.

9.4 Relays should be able to withstand Impulse and High Frequency Disturbance as per IS 8686: 1977.



9.5 All relays and timers shall be rated for control supply voltage as mentioned elsewhere and shall be capable of satisfactory continuous operation between 75-110% of the rated voltage.

9.6 Bidder shall furnish in their offers the details of Relays (make, type, range etc.) considered by them for each feeder in a tabular form together with descriptive literature of the Relays offered.

a) All relays shall be draw out type confirming to all requirements as per IS:3231 and shall be suitable for operation from CT secondaries as required. All static relays shall confirm to IS :8686 .

b) The protective relays, except for lock-out relays shall have self - reset contacts, and shall be suitable for efficient and reliable operation of the protective schemes

c) All timers shall be either electromagnetic or static type.

d) All relays & timers shall be designed for satisfactory performance under specified tropical and humid conditions.

e) The bidder shall include in his bid a list of installations where the relays offered are in trouble free operation.

f) The relays and timer shall operate under extreme conditions of control voltage variation.

g) They shall not have any inbuilt batteries, and shall operate on available DC supply. They shall be provided with hand-reset operation indicators (flags) or LEDs with pushbuttons for resetting and for analysing the cause of breaker operation.

h) Shall have built-in test facilities, or can be provided with necessary test blocks and test switches. One testing plug shall be provided for each switchboard.

i) The auto reclose logic shall be generated from local panel. The logic shall be, with the tripping of the feeder breaker under faults after a time delay of 1000 ms. closing command shall be given to particular breaker. If the breaker

close/trips then no further closing command shall be issued. However this shall not be used for, I/C, B/C and capacitor feeder.

j) Over voltage relay provided on bus PT shall be used as a backup.

k) The over voltage trip logic shall be extended only to capacitor feeder.

l) The protection relay should have potential free contacts as per the protection logic requirement.

m) Reverse blocking principle for the feeders with incomer shall be provided.

n) Intertripping of incomer with upstream breaker shall be provided.

o) Automatic power factor control relay shall be provided one in each section for switching on the capacitor

p) All equipment shall have necessary protections. However, following minimum protections shall be provided.

FEEDER TYPE	Differential (87T)	REF (64R)	Over Current -50	Over Current DMT(51)	Earth Fault (51N)	Under Voltage -27	Over Voltage -59	Fuse Failure
Incomer	Yes	Yes	Yes	Yes	Yes	-	-	-
Bus Coupler	-	-	-	Yes	Yes	-	-	-
Capacitor feeder	-	-	Yes	Yes	Yes	-	-	-
Normal feeder	-	-	Yes	Yes	Yes	-	-	-
Bus PT	-	-	-	-	-	Yes	Yes	Yes

q) The capacitor protection scheme shall be designed for the capacitor configuration given elsewhere.

## 10. Current transformers

10.1 Two core CTs shall be employed for measuring instruments and automatic tripping of circuit breakers on overload, Earth Fault and short circuit protection. CT can be mounted on cable side of breakers with easy accessibility. Class of accuracy and burden for protection CT shall be 5P10 and for metering CT the same shall be class 0.5. The VA burden of the CTs shall be min. 25% more than the calculated value. However, the min. VA burden of CTs shall be 20 VA. CT shall conform to IS : 2705 (Parts 1-4) 1992 with its latest amendments.

However bidder shall furnish the actual VA ratings calculation required for the CT considering the relays and meters provide, for employer approval.

10.2 All the CT's shall be cast resin insulated, Bar primary/Wound secondary type. All secondary connections shall be brought out through conduits to terminal blocks having provision of shorting links.

10.3 Ratio of the CT's shall be as indicated in the protection SLD.

10.4 Short time rating of CTs shall be 25 KA for 1 second. CTs shall be double core and dual ratio. Saturation factor for metering core shall not exceed 2.5.

10.5 The designed accuracy should be available even at the lowest ratios and all CTs shall withstand fault current corresponding to 25KA for 1 sec.

10.6 The secondary terminal of the current transformers shall be such that effective and firm wire terminations are possible. Shorting links of adequate capacity shall be provided at the terminal blocks for sorting of the leads from secondary terminals of current transformers. The secondary terminal of the CTs shall be earthed at one point.

10.7 The secondary winding resistance of CTs shall be as low as possible but not greater than 0.2 Ohms per 100 turns.

## **11. Potential transformers (PT)**

TWO (2) Nos. single phase units of  $((11/\sqrt{3}) \text{ kV}/(110/\sqrt{3})\text{V})$  PTs shall be mounted on incoming panels. HRC fuse protection of adequate rating shall be

provided on HT and LT side of PT. Accuracy class of PT shall be 0.5. The primary and secondary of these PTs shall be "Star" connected and used for, all protection and measuring purposes onboard viz. line volt meters, energy meters etc. PTs shall conform to IS:3156 (Parts 1-4):1992 with its latest amendments.

Potential transformers shall be cast resin, draw out type. PT changeover scheme shall be provided in the switchboard.

All PT should have suitable current limited fuse both at primary and secondary.

## **12. Cable glands and clamping arrangement for holding suitable cable boxes**

12.1 Two nos, brass-wiping glands for each incomer and one no. Brass wiping gland for each outgoing panel of adequate dimension for XLPE cable of 3 crores up to 400 sq. mm size (to be customized by utility) shall be supplied along with panels. For bus coupler no cable glands should be provided.

12.2 Suitable cable boxes as per requirement of cable shall be arranged by the bidder. The panel shall however provide a flat of size 50x6 mm<sup>2</sup> with suitable clamp made of 50x6 mm<sup>2</sup> flat along with Nuts Bolts and Washers for holding the cable boxes. The flat should be fitted at a suitable height with allotted arrangement for adjustment of height from 300mm to 500mm at site. The clamp and flat shall have suitable stud type arrangement for earthing cable and cable box.

12.3 All control cable/wire entries shall be by means of suitable cable glands, such glands shall be of brass and tinned.

## **13. Auxiliary/control wiring**

All the secondary wiring in the panel shall have high quality PVC insulation and the same shall have conductor size of not less than 2.5 mm<sup>2</sup> of copper. Colors of the secondary/auxiliary wiring should confirm to IS 375/1963 and latest amendment thereof if any. All wiring shall be neatly run and group of wiring shall be securely fixed by clips so that wiring can be checked without necessity of removing the clamps. Wiring between fixed and moving portion of the panel shall be run in flexible tubes and the same shall be so mounted to

avoid any damage to them due to mechanical movements. Ferrules with number shall be provided on both end of the wiring.

#### **14. Static energy meters - Deleted**

#### **15. Painting**

All metallic surface [except enameled and bright parts] exposed to weather shall be given suitable primer coat and two coats of first quality paint of approved color. The supplier shall also supply adequate quantities of paints, Varnish etc. for use of finished cost and for use of patching up any scratches received during transport, handling erection testing and commissioning.

Instead of above proper powder coating after proper pre-treatment is acceptable and in that case earlier condition will not applicable.

#### **16. Tests**

The design of circuit breaker shall be proven through all the routine and type tests in accordance with IS 13118: 1991/IEC 56 and any amendment thereof. Photocopy of all the test reports must be enclosed with the tender. Type test report earlier than 5 year from the date of tender opening shall not be acceptable.

#### **17. Technical Parameters (to be customized by utility as per capacity and requirement)**

##### **17.1 11 kV Circuit Breakers**

Sl.No.	DESCRIPTION	VALUES
i)	Rate Voltage (kV rms)	11 kV
ii)	Rated frequency (Hz)	50
iii)	System neutral earthing	Solidly grounded system

iv)	Type of arc quenching medium	Vacuum
v)	Rated normal current at site conditions (Amps)	1600 Amp for I/C breaker and Bus Coupler and 800 Amp for Outgoing feeders
vi)	Number of poles	3
vii)	Installation	Indoor type
viii)	Temperature rise	As per IEC 56 (Table-4) Page-19
ix)	Rated short circuit	
	a) Interrupting capacity at 11 kV	25 kA
	b) The percentage DC components	As per IEC 56 & (Ref. Page 51, 21 of IEC)
	c) Minimum number of Short Circuit operation the Circuit Breaker can withstand	100
x)	Rated short circuit making capacity	62.5 KA
xi)	First pole to clear factor	1.5
xii)	Rated short time current carrying capacity	25 kA
xiii)	Rated duration of short circuit	1 Seconds
xiv)	Total break time for any current upto the rated breaking current with limiting condition of operating and quenching media pressure (ms)	As per IS/IEC
xv)	Closing time (rms)	As per IS/IEC
xvi)	Standard value of rated transient recovery voltage for terminal fault	As per IEC-56
xvii)	Standard value of rated line	

	Characteristics for short line faults	
	RRRV	KV/ms=0.214
	Surge Peak Factor	Factor K=1.6 A
	Impedance	Z (ohms) = 450
xviii)	Rated operating	
	a) Duty cycle	O-0.3 Second-CO-3 Minutes-CO
	b) Auto reclosing	Suitable for three phase Auto reclosing
xix)	Rated insulation level under heavy pollution condition 1.2/50 micro second lightning Impulse withstand voltage (kV peak) to earth	75 kV
xx)	Power frequency withstand voltage kV (rms) to earth (kV rms)	28 kV
xxi)	Rated characteristic for out of Phase breaking	
	a) Out of phase breaking capacity	25% of rated breaking capacity
	b) Standard values of transient recovery	As per IEC-56
	c) Operating mechanism	Spring operated, Anti pumping and Trip free mechanism
	d) Power available for operating mechanism	Three phase 415 Volts 50 C/S or single phase 50 C/S 240 Volts
xxii)	a) Rated supply voltage of closing and operating devices and auxiliary circuits	1) 220 VDC 2) 240 Volts AC 50 C/S single phase 3) 415 Volts 50 Hz three phase
	b) Permissible voltage variation	1) In case of DC Power supply voltage variation shall be between 85% to 110% of normal voltage. 2) In case of AC power supply voltage variation shall be of the normal voltage as per IS-15% to +10%

	c) Permissible frequency	$\pm 3\%$ from normal 50 Hz as per IS : 2026 Part-I 1977 para 4.4
	d) Combined variation of frequency and voltage	$\pm 15\%$
xxiii)	Number of auxiliary contacts	10 NO and 10 NC on each pole Continuous current rating 10 Amps, DC breaking rating capacity shall be 2 Amps with circuit time constant less than 20 ms at 220/30 volts DC
xxiv)	Number of coils	1 (One) trip coils and 1 close coil with anti-pumping arrangement
xxv)	Rated terminal load	100 kg. Static. The breaker shall be designed to withstand the rated terminal load, wind, load, earthquake load and short circuit forces.

### 18. Completeness Of Equipment:

Any fittings, accessories or apparatus which may not have been specifically mentioned in this specification but which are usually necessary for the satisfactory operation of the equipment, shall be deemed to have been included in this specification.

### 19. Packings:

All material shall be suitably packed for transport, direct to site and Manufacturer shall be responsible for all damages/losses due to improper packing. All boxes shall be marked with signs indicating the up and down sides of the boxes along with the unpacking instructions, if considered necessary by the Manufacturers.



## 67. 11KV CAPACITOR BANK

### 1. General

The manufacturer with 2.5 MVAR, 11 kV class capacitors offered, should have designed, manufactured, type tested as per relevant IEC/IS, supplied in the last three years for system voltage of 11 kV or higher.

This specification covers the basic requirements in respect of Capacitor Banks with internal/external fuse, mounting racks, supporting structure complete in all respect along with series reactors.

### 2. Standards

The Shunt Capacitor Bank and associated equipment shall conform to the latest additions of the following standards except to the extent explicitly modified in the specification and shall also be in accordance with requirements specified in this specification.

Capacitor	IS : 13925
Series Reactor	IS : 5553
Internal Fuse	IEC 593/IS 12672
External Fuse	IEC 549/IS 9402

### 3. General arrangement of capacitor banks

a) The Capacitor Bank shall be of outdoor type suitable for operation in the climatic conditions as given in this specification and mounted on steel racks and structure with suitable insulators as required to be supplied by the bidder.

b) The bidder shall furnish details of connections between the Capacitor units and groups together with layout diagram showing the basic arrangement of banks complete with dimensions.

### 4. Design criteria requirement and constructional details of capacitor

i) Each bank shall be made up by two groups of star connected banks each star connected bank shall be unearthed, with a floating neutral, but interconnected by a Neutral Protective Current Transformer (NCT) of suitable ratio to operate protective relays. The NCT secondary current shall be 1A and its ratio decided by design to meet with the protection requirements specified.

ii) The protective scheme shall be either by two step current relay arranged as follows:

If the failure of one or more units causes an over voltage of less than 10% tolerable on the other remaining healthy units, then the unbalance current shall cause in the first step to sound an alarm. But if more than the above number of units fails causing a voltage rise of more than 10% the unbalance current shall cause to trip and isolate the capacitor bank instantaneously.

iii) The per phase and individual star group rating shall be built up by series – parallel combination of individual units so as to achieve the desired bank rating. The individual capacity ratings shall be as per IS: 2834.

iv) All parallel units in one series group shall preferably be arranged in different tiers that is one series group shall be duly insulated from one another by post insulators adequate to withstand the voltage that may be impressed and shall be sufficient to withstand even in case of total failure of all the parallel units in a series group. The complete assembly shall also be duly insulated from the earth potential by supporting post insulators.

v) Although the tolerances in the output rating of each individual unit shall be as per IS:2834 yet it shall be ensured that in a completely assembled bank, the departures from the nominal rating and within the specified tolerances values shall not cause nuisance alarm or tripping since such alarm or tripping shall be to meet only with the protective requirements specified.

vi) The tolerances in the output ratings shall not cause departures in the line currents by that value specified in IS: 2834. Besides it shall also be ensured that these unsymmetrical currents shall not cause unsymmetrical voltage rises, whether for short periods or during prolonged operation.

vii) Individual units shall be designed to meet with the requirements of the permissible overloads as specified as per IS: 2834. Each unit shall also be

provided with internal discharge devices complying with the requirements of the IS.

viii) The voltage rating of the NCT shall be decided by the Bidder by taking into consideration the voltage impressed on the NCT due to:

a) Voltage due to failure of one or more parallel units in a series bank.

b) Voltage impressed on the NCT when all the parallel units in one series bank fail simultaneously. The bidders shall furnish along with the bid design calculations for the same.

### **5. Capacitor units**

a) Each capacitor unit in the Bank shall be self-contained outdoor type having 2 bushing suitably rating for series/parallel connections with other units to form the capacitor bank of rated capacity at 50 Hz. The bushing shall be of porcelain and shall be joined to the case by soldering or welding.

b) The capacitor unit shall be manufactured Hazy Polypropylene as dielectric using non PCB impregnation shall be carried out under high degree of vacuum and the unit shall be of totally sealed type.

c) Each capacitor unit shall be provided with a internal discharge resistor designed to drain the phase voltage of the bank to 50 V or less within 5 minutes after disconnection from the supply.

d) Each capacitor unit shall be suitable for continuous operation at least 1.3 times the rated current at rated voltage and frequency. This over current factor shall include the combined effect of presence of harmonics and over-voltage up to 1.1 times rated voltage.

e) The container of capacitor unit shall be of stainless steel or CRCA steel painted within suitable anti-rust primer and two finishing coats of paint as per manufacturers' standard practice. The container shall be made from sheet steel of suitable thickness designed to allow for expansion and contraction due to all ambient and loading conditions expected during the life of the unit.

f) In case of externally fused capacitors the rating of unit shall so chosen that failure of 2 units in a particular series group shall not cause over-voltage exceeding 10% on the other healthy unit in that same series group. Calculations on above showing the justification of the unit size shall be furnished by the bidder along with the offer.

g) The design of the internally fused capacitor unit shall be such that it shall permit up to 40% element failure in series group without passing more than 10% over voltage on the other healthy units.

h) Each capacitor unit shall be mounted so that it can be easily removed from the racks and replaced without removing other units, de-assembling any portion of the rack.

i) Protective fuses: the capacitor units shall be provided with either internal or external fuses as per standard practice of the manufacturer.

#### **A. Capacitor units with internal fuses**

The internal fuses shall conform to IEC:593/IS:12672 and the Bidder shall furnish type test certificates for compliance with IEC/IS. The design of the internal fuse shall be same that residues from fuse operation(s) shall not cause deterioration of the impregnating fluid. The fuse assembly shall be distinct and separate from element packs and so constructed that operation of a fuse indoor worst condition does not affect the other healthy elements. The fuses shall not melt or deteriorate when subjected to inrush currents, which occur during the life of the bank. The design of the fuse shall be such that it shall isolate only the faulty element and the operation of the fuse shall not affect the other healthy elements.

#### **B. Capacitor units with external fuses**

The external fuses shall be of current limiting (HRC) type. The fuse system shall in any event be designed to ensure that the energy released into a faulty capacitor unit is less than the value that will cause rupture or bursting of the container. The fuses shall conform to IEC: 549/IS: 9402 and Bidder shall furnish type test certificate for compliance with IEC/IS. The characteristics of the fuse shall be such that it shall isolate the faulty unit only and prevent it from mechanical destruction due to internal faults. The capacitor unit together with external fuses shall be arranged in the bank by providing adequate clearance

between the body of the capacitor units of a phase and the line terminal or the common bus for the units of the other phases to obviate the possibility of occurrence of bird faults. The fuse shall isolate the faulty capacitor unit only and the healthy capacitor units shall not be affected in any way by the isolation of faulty unit. The fuses shall not melt or deteriorate when subject to inrush currents which occur during the life of the bank. The external distance between two metal ends of the fuse shall comply with specified creepage distance (i.e. the length of the insulating part of the fuse shall be such that the specified creepage distance is achieved). The selection of fuse to be done in such a manner that characteristic of fuse shall match suitably with over current withstand characteristic of associated capacitor unit.

The capacitor bank and protection shall be such that failure of one unit (i.e. one external fuse operation) does not cause tripping of the bank. The bidder shall furnish detailed calculations in evidence of above along with the Bid.

Metalised Polypropylene Type, self-healing design capacitor with internal safety design is also acceptable. Bidder shall explain the features and properties of the capacitor offered to meet the requirement described above. These shall have discharge resistance provided internally to eliminate stress in case of de-energisation.

## **6. Mounting racks**

- a) The mounting racks shall be hot dip galvanized steel sections. Each end of the rack shall have provision to receive incoming line connection.
- b) The racks shall be complete with rack insulators, foundation bolts or any other hardware etc. for assembly into complete bank.
- c) The height of the racks of capacitor banks shall be such that for making electrical connections with other equipment, proper electrical clearances are maintained.
- d) The capacitor bank along with its mounting racks and series reactor and null CT shall be suitable for installation on the plinth and the enclosure shall be suitably fenced and interlocked as per safety requirements.

## **7. Tests**

- a) Type Tests – The equipment shall comply with the requirements of type test as per IS: 2834 and copies of these type test reports should be submitted along with offer. The capacitor offered must have been also endurance tested as per

IEC: 871-2/IS: 13925 and copies of reports submitted along with offer. The capacitors under the type tested as per relevant IS/IEC.

b) Acceptance and routine tests – The equipment shall comply with all routine and acceptance tests as per IS – 2834. Sampling to be done as per Appendix-E, IS-2834.

### 8. Series reactors

a) The series reactor of small size (as required) shall be used in the Capacitor banks for limiting the inrush current. The series reactor shall be outdoor type 50 Hz, air-cooled air core type and suitable for operation in climatic conditions specified.

b) Series reactors shall be capable of withstanding the specified short circuit currents.

c) The percentage series reactance shall preferably be 0.2%. However, the value of series reactance shall be decided during detailed engineering. The Bidder shall furnish calculations justifying the value selected.

d) The series reactors shall conform to type tests and shall be subjected to routine tests as per IS.

### 9. Technical parameters of capacitors and series reactors

The capacitor units and series reactors and other equipments/materials covered in this specification shall meet the technical requirements listed hereunder:

#### Capacitor Units (to be customized by utility)

S.No	ITEM	SPECIFICATION
a)	Nominal System Voltage (kV)	11
b)	MVAR Capacity required at nominal system voltage (MVAR)	2.5
c)	Rated voltage of this capacitor bank (kV)	12
d)	Protection of Capacitor units	Internal / External fuses

e)	Type of connection	Double Star
f)	Unit Size	Option of the manufacturer to chose the appropriate unit size and rating
g)	Power loss (tan delta including loss in the fuse)	Not to exceed 0.2 Watt per applicable standards.
h)	Permissible overloads	Max. permissible Overloads with reference to voltage current and reactive output shall conform to Applicable standards.
i)	Type of grounding	Ungrounded
j)	Type of discharge	Internally through Resistor provided within the capacitor unit
k)	Capacity to receive inrush current	Not less than 100 times rated current
l)	Temperature category	The capacitors shall be suitable for maximum ambient temperature of 50 deg. C adequate care should be taken to protect the capacitors from direct sun radiations on account of Outdoor

		installations.
--	--	----------------

### 10. Series reactors

S.No.	ITEM	SPECIFICATION
a)	Rated Voltage (kV)	12
b)	Type	Air core
c)	Rating of series reactors	0.2% of Capacitor bank rating to be connected on neutral end
d)	Insulation levels Impulse withstand voltage(KVp)	75
e)	Short time withstand capacity and duration	16 times of 130% rated current of capacitor bank for 3 seconds
f)	Linear characteristic	Upto 1.5 pu
g)	Continuous rating	130% of rated current of capacitor bank

### 11. Completeness of equipment:

Any fittings, accessories or apparatus which may not have been specifically mentioned in this specification but which are usually necessary for the satisfactory operation of the equipment, shall be deemed to have been included in this specification.

### 12. Packings:

All material shall be suitably packed for transport, direct to site and Manufacturer shall be responsible for all damages/losses due to improper packing. All boxes shall be marked with signs indicating the up and down sides



of the boxes along with the unpacking instructions, if considered necessary by the Manufacturers.

**68. Outdoor Non Sealed Type Three Phase 11 Kv/433v Station Transformers**

**(refer Section 6, Part -2 for Tech Specification)**

**69. ACSR Conductor**

**(refer Section 6, Part -2 for Tech Specification)**

## **70. Installation**

### **1. Earthing**

The earthing shall be done in accordance with requirements. Earthing of panels shall be done in line with the requirements given in respective equipment section of this specification.

### **2. Civil Works**

The civil works shall be done in accordance with requirements stipulated under Section-17 of this specification.

### **3. Structural Steel Works**

The structural steel works shall be done in accordance with requirements stipulated under Section-17 of this specification.

### **4. Bay Equipment**

4.1 The disposition of equipment to be supplied is shown in enclosed single line diagrams and layout drawings.

4.2 The Bidder shall prepare layout drawings and submit the same for approval of the EMPLOYER. The approval of drg. shall not absolve Bidder from his responsibility regarding designing & engineering of Sub-Station and Bidder shall be fully responsible for all works covered in the scope of this specification.

### **5. Lightning Protection**

Detailed drawings shall be submitted for approved locations on Sub-Station towers provision of lightning rod electrode at suitable Location.

5.1 Lightning protection System down conductors shall not be connected to other conductors above ground level. Also no intermediate earthing connection shall be made to Surge arrester, Voltage Transformer, earthing leads for which they shall be directly connected to rod electrode.

5.2 Every down conductor shall be provided with a test joint at about 150 mm above ground level. The test joint shall be directly connected to the earthing system.

5.3 The lightning protection system shall not be in direct contact with underground metallic service ducts and cables.

## **6. Equipment Erection Notes**

a. All support insulators, circuit breaker interrupters and other fragile equipment shall be handled with cranes with suitable booms and handling capacity.

b. Where, assemblies are supplied in more than one section, Bidder shall make all necessary mechanical and electrical connections between sections including the connection between buses. Bidder shall also do necessary adjustments/alignments necessary for proper operation of circuit breakers, isolators and their operating mechanisms. All components shall be protected against damage during unloading, transportation, storage, installation, testing and commissioning. Any equipment damaged due to negligence or carelessness or otherwise shall be replaced by the Bidder at his own expense. The Bidder shall strictly follow manufacturer's recommendations for handling and erection of equipment.

c. The slings shall be of sufficient length to avoid any damage to insulator due to excessive swing, scratching by sling ropes etc. Handling equipment, sling ropes etc. should be tested before erection and periodically thereafter for strength.

d. Bending of piping should be done by a bending machine and through cold bending only. Bending shall be such that inner diameter of pipe is not reduced. The pipes shall be thoroughly cleaned before installation.

e. Cutting of the pipes wherever required shall be such as to avoid flaring of the ends. Hence only a proper pipe cutting tool shall be used. Hack saw shall not be used.

f. For cleaning the inside and outside of hollow insulators only Muslin or leather cloth shall be used.

## **7. Storage Of Equipment**

Bidder is responsible for the proper storage and maintenance of all materials/equipment to be supplied by him for the work. The Bidder shall provide & construct adequate storage shed for proper storage of equipment. Sensitive equipment shall be stored indoors. All equipment during storage shall be protected against damage due to acts of nature or accidents. Bidder shall take all required steps to carryout subsequent inspection of materials/equipment stored as well as erected until the same is taken over by the EMPLOYER. The storage instruction of the equipment manufacturers/ Engineer-in-Charge shall be strictly adhered to.

## **8. Cabling**

8.1 Cabling shall be in trenches, excavated trenches for direct burial, pulled through pipes and conduits run clamped on steel structures etc.

8.2 Cables inside the Sub-Station shall be laid on angle supports at 600mm spacing with separate tiers for control and power cables.

8.3 All interpole cables (both power & control circuit) for equipments shall be laid in cable trenches/G.I. Conduit Pipe of NB 50/100mm which shall be buried in the ground at a depth of 300mm.

## **9. Conduits, Pipes And Accessories**

9.1 The bidder shall supply and install all rigid conduits, mild steel pipes, flexible conduits, hume pipes etc. including all necessary sundry materials, such as tees, elbows, check nuts, bushings, reducers, enlargers, wooden plugs, coupling caps, nipples, gland sealing fittings, pull boxes etc. The size of the conduit/pipe shall be selected on the basis of maximum 40% fill criterion. All conduits/pipes shall have their ends closed by caps until cables are pulled. After cables are pulled, the ends of conduits/pipes shall be sealed in an approved manner, to prevent damage to threaded portion and entrance of moisture and foreign material.

9.2 Rigid conduits shall be flow-coat metal conduits of XXX (name) Coated Tubes or equivalent make. The outer surface of the conduits shall be coated with hot-dip zinc and chromate coatings. The inner surface shall have silicone epoxy ester coating for easy cable pulling. Mild steel pipes shall be hot-dip galvanised. All rigid conduits/pipes shall be of a reputed make.

9.3 The hume pipes and accessories shall be of reinforced concrete conforming to class NP2 of IS: 458. All tests on hume pipes shall be conducted as per IS: 458.

## **10. Cable Tags And Marker**

10.1 Each cable and conduit run shall be tagged with numbers that appear in the cable and conduit schedule.

10.2 The tag shall be of aluminium with the number punched on it and securely attached to the cable conduit by not less than two turns of 20 SWG GI wire conforming to IS:280. Cable tags shall be of rectangular shape for power cables and of circular shape for control cables.

10.3 Location of cables laid directly underground shall be clearly indicated with cable marker made of galvanised iron plate.

10.4 The marker shall project 150mm above ground and shall be spaced at an interval 30 meters and at every change in direction. They shall be located on both sides of road and drain crossings.

10.5 Cable tags shall be provided on all cables at each end (just before entering the equipment enclosure), on both sides of a wall or floor crossing, on each duct/conduit entry. Cable tags shall be provided inside the switchgear, motor control centres, control and relay panels etc., wherever required for cable identification, such as where a number of cables enter together through a gland plate.

10.6 Specific requirements for cabling, wiring ferrules as covered in respective equipment section shall also be complied with.

## **11. Storage And Handling Of Cable Drums**

Cable drums shall be unloaded, handled and stored in an approved manner and rolling of drums shall be avoided as far as practicable. For short distances, the drums may be rolled provided they are rolled slowly and in proper direction as marked on the drum. In absence of any indication the drums may be rolled in the same direction it was rolled during taking up the cables.

## **12. Cable Supports And Cable Tray Mounting Arrangements**

12.1 In cases where no embedded steel inserts are available, the Bidder shall have to secure the supports on wall or floors by suitable anchoring at no extra cost to the Employer. Details of fixing steel plates by anchor fasteners shall be decided during detailed engineering stage.

12.2 The cable supports shall conform to the requirements of this Specification.

12.3 Insert plates will be provided at an interval of 600mm wherever cables are to be supported without the use of cable trays, while at all other places these will be at an interval of 2000mm.

### **13. Cable Terminations And Connections**

13.1 The termination and connection of cables shall be done strictly in accordance with cable and termination kit manufacturer's instructions, drawing and/or as directed by the Employer.

13.2 The work shall include all clamping, fittings, fixing, plumbing, soldering, drilling, cutting, taping, heat shrinking, (where applicable), connecting to cable terminal, shorting and grounding as required to complete the job.

13.3 Cost of all consumable material shall be included in the erection rates quoted.

13.4 The equipment will be generally provided with undrilled gland plates for cables/conduit entry. The Bidder shall be responsible for drilling of gland plates, painting and touching up. Holes shall not be made by gas cutting.

13.5 The Bidder shall tag/ferrule the control cable cores at all terminations, as instructed by the Employer. In panels where a large number of cables are to be terminated and cable identification may be difficult, each core ferrule may include the complete cable number as well.

13.6 Spare cores shall be similarly tagged with cable numbers and coiled up.

13.7 Control cables shall have stranded copper conductor. Bare portion of the solid conductors shall be tinned after removing the insulation and shall be terminated directly without using cable lugs.

13.8 All cable entry points shall be sealed and made vermin and dust proof. Unused openings shall be effectively closed.

13.9 If the cable end box or terminal enclosure provided on the equipment is found unsuitable and requires modification, the same shall be carried out by the Bidder as directed by the Employer.

#### **14. Directly Buried Cables**

The Bidder shall construct the cable trenches required for directly buried cables. The scope of work and unit rates for construction of cable trenches for cables shall include excavation, preparation of sand bedding, soil cover, supply and installation of brick or concrete protective covers, back filling and reaming, supply and installation of route markers and joint markers. The bidder shall ascertain the soil parameters prevailing at site, before quoting the unit rates. Laying the cable and providing protective covering shall be as per approved drawing.

#### **15. Installation of Cables**

15.1 Power and control cables shall be laid in separate tiers. The order of laying of various cables shall be as follows, for cables other than directly buried.

a) Power cables on top tiers.

b) Control, instrumentation and other service cables in bottom tiers.

15.2 Single core cables in trefoil formation shall be laid with a distance of three times the diameter of cable between trefoil centre lines. All power cables shall be laid with a minimum centre to centre distance equal to twice the diameter of the cable.

15.3 Power and control cables shall be securely fixed to the supports. Trefoil clamps for single core cables shall be pressure die-cast aluminium (LM-6), Nylon-6 or fibre glass and shall include necessary fixing GI nuts, bolts, washer, etc. these are required at every 2 metre of cable runs.



15.4 Cables shall not be bent below the minimum permissible limit. The permissible limits are as follows:

	Type of cable & voltage grade	Minimum bending radius
a)	Power cable	12 D
b)	Control cables	10 D

Where D is overall diameter of cable.

15.5 Where cables cross roads, drains and rail tracks, the cables shall be laid in reinforced spun concrete or steel pipes, buried at not less than one metre depth.

15.6 In each cable run some extra length shall be kept at a suitable point to enable one (for LT Cables) or two (for H.T cables) straight through joints to be made, should the cable develop fault at a later date.

15.7 Selection of cable drums for each run shall be so planned as to avoid using straight through joints. In case joints are necessary the same shall be supplied by the Bidder. Cable splices will not be permitted except where called for by the drawings, unavoidable or where permitted by the Employer.

15.8 Control cable terminations inside equipment enclosures shall have sufficient lengths so that switching of termination in terminal blocks can be done without requiring any splicing.

15.9 Metal screen and armour of the cable shall be bonded to the earthing system of the station, wherever required.

15.10 Rollers shall be used at intervals of about 2.0 metres, while pulling cables.

15.11 All due care shall be taken during unreeling, laying and termination of cable to avoid damage due to twist, kink, sharp bends etc.

15.12 Cable ends shall be kept sealed to prevent damage.

15.13 Inspection on receipt, unloading and handling of cables shall generally be in accordance with IS: 1255 and other Indian Standard Codes of practices.

15.14 Wherever cables pass through floor or through wall openings or other partitions, wall sleeves with bushes having a smooth curved internal surface so as not to damage the cables, shall be supplied, installed and properly sealed by the Bidder at no extra charges.

15.15 The erection work shall be carried out in a neat workmanlike manner and the areas of work shall be cleaned of all scrap materials, etc. after the completion of work in each area every day. Bidder shall remove the RCC/steel bench covers before taking up the work and shall replace all the trench covers after the erection work in that particular area is completed or when further work is not likely to be taken up for some time.

15.16 Bidder shall furnish three copies of the report on work carried out in a particular week, such as cable numbers and a date on which laid, actual length and route, testing carried out, along with the marked up copy of the cable schedule and interconnection drawing wherever any modifications are made.

15.17 In case the outer sheath of a cable is damaged during handling/installation, the Bidder shall repair it at his own cost, and to the satisfaction of the Engineer-in-Charge. In case any other part of a cable is damaged, the same shall be replaced by a healthy cable, at no extra cost i.e. the Bidder shall not be paid for installation and removal of the damaged cable.

15.18 All cable terminations shall be appropriately tightened to ensure secure and reliable connections. The Bidder shall cover the exposed part of all cable lugs whether supplied by him or not with insulating tape, sleeve or paint.

## **16. Conduits, Pipes Installation**

16.1 Bidder shall supply all conduits, pipes and ducts as specified and to be shown in detailed engineering drawing. Flexible conduit should be used between fixed conduit and equipment terminal boxes. Where vibration is anticipated, the flexible conduit shall be as per the relevant IS.

16.2 Bidder shall have his own facility for bending, cutting and threading the conduits at site. Cold bending should be used. All cuts & threaded ends shall be

made smooth without leaving any sharp edges. Anti corrosive paint shall be applied at all field threaded portions. The Bidder shall supply and apply this protective material.

16.3 All conduit/pipes shall be extended on both sides of wall/floor/openings. Exposed conduits/pipes shall be adequately clamped at an interval of about 2m. The fabrication and installation of supports and the clamping shall be included in the scope of work by Bidder.

16.4 When two lengths of conduits are joined together through a coupling, running threads equal to twice the length of coupling shall be provided on any length to facilitate easy dismantling of two conduits.

16.5 Conduit installation shall be permanently connected to earth by means of special approved type of earthing clamps. G.I. Pull wire of adequate size shall be laid in all conduits before installation.

16.6 Each conduit run shall be painted with its designation as indicated on the drawings, such that it can be identified at each end.

16.7 Embedded conduits shall have a minimum concrete cover of 50mm. Positioning and ensuring proper alignment during concrete by other agencies shall be the responsibility of the Bidder.

16.8 Conduit runs sleeves shall be provided with the bushings at each end.

16.9 Metallic conduit runs at termination shall have two locknuts and a bushing for connection. Flexible conduits shall also be suitably clamped at each end. Bushings shall have rounded edges so as not to damage the cables.

16.10 Where embedded conduits turn upwards from a slab or fill, the termination dimensions shown on the drawings, if any, shall be taken to represent the position of the straight extension of the conduit external to and immediately following the bend. At least one half the arc length of the bend shall be embedded.

16.11 For underground runs, Bidder shall excavate and back fill as necessary.

## ANNEXURE-I : Earthing Notes

### 1. General

1.1 Neutral points of systems of different voltages, metallic enclosures and frame works associated with all current carrying equipments and extraneous metal works associated with electric system shall be connected to a single earthing system unless stipulated otherwise.

1.2 Earthing system installation shall be in strict accordance with the latest editions of Indian Electricity Rules/CEA Regulations, relevant Indian Standards and Codes of practice and Regulations existing in the locality where the system is installed.

1.3 Bolts and nuts required for earthing all main equipment structures and for connecting with earthing system shall be in the scope of the Bidder.

### 2. Details Of Earthing System

Item	Size	Material
Main Earthing conductor	Suitable for a system current of 31.5 KA/1s as per IS	Mild Steel
Conductor above ground & earthing leads (for equipment)	To be submitted by the vendor as per above	Galvanized Steel
Rod Electrode	Suitable for a system current of 31.5 kA/ 1s as per IS	Mild steel
G.I. Earthwire	7/8 SWG	GI

### 3. Earthing Conductor Layout

3.1 Earthing conductors in outdoor areas shall be buried at least 600mm below finished grade level unless stated otherwise.

3.2 Minimum 3000 mm spacing between rod electrodes shall be provided unless stipulated otherwise.

3.3 Wherever earthing conductors cross cable trenches, underground service ducts, pipes, tunnels, railway tracks etc., it shall be laid at least 300 mm below them and shall be re-routed in case it fouls with equipment/structure foundations.

3.4 Tap connections from the earthing grid to the equipment/structure to be earthed, shall be terminated on the earthing terminals of the equipment/structure, if the equipment is available at the time of laying the grid. Otherwise, "earth insert" with temporary wooden cover or "earth riser" shall be provided near the equipment foundation / pedestal for future connections to the equipment earthing terminals.

3.5 Earthing conductor along their run on cable trench ladder columns, beams, walls, etc. shall be supported by suitable welding/cleating at intervals of 750 mm. Earthing conductors along cable trenches shall be on the wall nearer to the equipment. Wherever it passes through walls, floors etc. galvanized iron sleeves shall be provided for the passage of the conductor. Both ends of the sleeves shall be sealed to prevent the passage of water through the sleeves.

3.6 Earthing conductor around the building shall be buried in earth at a minimum distance of 1500mm from the outer boundary of the building. In case high temperature is encountered at some location, the earthing conductor shall be laid minimum 1500mm away from such location.

3.7 In outdoor areas, tap connections shall be brought 300mm above ground level for making connections in future, in case equipment is not available at the time of grid installations.

3.8 Earthing conductors crossing the road shall be either installed in hume pipes or laid at greater depth to suit the site conditions.

3.9 Earthing conductors embedded in the concrete fibre shall have approximately 50mm concrete cover.

#### **4. Equipment And Structure Earthing**

4.1 The connection between earthing pads and the earthing grid shall be made by short and direct earthing leads free from kinks and splices. In case earthing pads are not provided on the item to be earthed, same shall be provided in consultation with engineer. The equipments shall be earthed at two distinctive points on panels.

4.2 Metallic pipes, conduits and cable tray sections for cable installation shall be bonded to ensure electrical continuity and connected to earthing conductors at regular interval. Apart from intermediate connections, beginning points shall also be connected to earthing system.

4.3 Metallic conduits shall not be used as earth continuity conductor.

4.4 A separate earthing conductor shall be provided for earthing lighting fixtures, lighting poles, receptacles, switches, junction boxes, lighting conduits, etc.

4.5 Wherever earthing conductor crosses or runs along metallic structures such as gas, water, steam, conduits, etc. and steel reinforcement in concrete it shall be bonded to the same.

4.6 Cable and cable boxes/glands, lockout switches etc. shall be connected to the earthing conductor running along with the supply cable which, in turn, shall be connected to earthing grid conductor at minimum two points, whether specifically shown or not.

4.7 Railway tracks within Sub-Station area shall be bonded across fish plates and connected to earthing grid at several locations.

4.8 Earthing conductor shall be buried 2000mm outside the Sub-Station fence. Every post of the fence and gates shall be connected to earthing loop by one lead.

4.9 Flexible earthing connectors shall be provided where flexible conduits are connected to rigid conduits to ensure continuity.

## **5. Jointing**

5.1 Earthing connections with equipment earthing pads shall be of bolted type. Contact surfaces shall be free from scales, paint, enamel, grease, rust or dirt. Two bolts shall be provided for making each connection. Equipment bolted connections, after being checked and tested, shall be painted with anti-corrosive paint/compound.

5.2 Connection between equipment earthing lead and between main earthing conductors shall be welded/brazed type. For rust protections, the welds should be treated with red lead and afterwards thickly coated with bitumen compound to prevent corrosion.

5.3 Steel to copper connections shall be brazed type and shall be treated to prevent moisture ingress.

5.4 Resistance of the joint shall not be more than the resistance of the equivalent length of the conductor.

5.5 All ground connections shall be made by electric arc welding. All welded joints shall be allowed to cool down gradually to atmospheric temperature before putting any load on it. Artificial cooling shall not be allowed.

5.6 Bending of large diameter rod/thick conductor shall be done preferably by gas heating.

5.7 All arc welding with large diameter conductors shall be done with low hydrogen content electrodes.

## **6. Power Cable Earthing**

Metallic sheaths and armour of all multi core power cables shall be earthed at both equipment and switchgear end. Sheath and armour of single core power cables shall be earthed at switchgear end only.

## **7. Specific Requirement For Earthing Systems**

7.1 Earthing terminal of each surge arrester, capacitor voltage transformer and lightning down conductors shall be directly connected to rod electrode which in turn, shall be connected to station earthing grid.

7.2 Earthing mat comprising of closely spaced (300mm x 300mm) conductors shall be provided below the operating handles of the isolators.

7.3 For specific requirements for earthing at panel refer to Section-Control and Relay Panel of this specification.

### **8. Specific Requirements For Lightning Protection System**

8.1 Conductors of the lightning protection system shall not be connected with the conductors of the safety earthing system above ground level.

8.2 Down conductors shall be cleated on the structures at 2000mm interval.

8.3 Connection between each down conductor and rod electrodes shall be made via test joint located approximately 150mm above ground level.

8.4 Lightning conductors shall not pass through or run inside G.I. conduits.

8.5 Lightning protection system installation shall be in strict accordance with the latest editions of Indian Electricity Rules/CEA regulations, Indian Standards and Codes of practice and Regulations existing in the locality where the system is installed.

### **9. Procedure For Non Destructive Testing**

#### **A) LIQUID PENETRANT EXAMINATION OF WELDED JOINTS**

a) Evaluation of indications – As per standard Test Procedure.

**B) RADIOGRAPHIC EXAMINATION OF WELDED JOINTS** to be carried out as per standard test procedure on 10% welded joint.



## **71. Technical Specifications For 66 kV Gas Insulated Switchgear**

### **1.1 General**

The specification covers scope of design, engineering, fabrication, manufacturing, shop assembly, inspection and testing before supply, transportation, delivery at destination, unloading & storage at site, site erection, site testing, commissioning and putting in to successful operation complete with all materials, support structures, anchoring bolts, accessories, commissioning spares & maintenance spares (utility to specify requirements), special spanners, tools & tackles, any specific required ancillary services, SF6 Gas for first filling & spare, etc., for efficient and trouble free operation along with for 66 kV metal (aluminum alloy) encapsulated SF6 gas insulated switch-gear suitable for INDOOR installation.

The scope also covers provision of additional bays (without equipment) over and above bays shown in SLD, with foundations & earthing arrangements so as to install the bay module as and when required without any works pending except the procurement of the required bay module and other related equipment.

### **1.2 Design Concept, construction & performance of SF6 GIS**

**1.2.1** It is understood that each manufacture has its own particular SF6 GIS design concept and it is not the purpose of this specification to impose unreasonable restrictions. However, in the interest of safety, reliability and serviceableness, the switch gear offered shall meet the following minimum requirements.

The station layout and equipment rating shall be based on the single line diagram and general layout enclosed. The supplier has to work out an optimum layout and building size based on the specific features of his product within the constraints of overall dimensions of the plot.

All equipment, accessories and wiring shall have tropical protection, involving special treatment of metal and insulation against fungus, insects and corrosion.

Furthermore, no part of the enclosure, or any loose parts may fly off the switchgear in such an event, and no holes may burn through the enclosure until the nearest protective relay has tripped. All grounding connections must remain operational during and after an arc fault.

Proper grounding for mitigating over voltages during disconnector operation shall be included.

Viewing windows shall be provided at the Disconnectors and earthing switches to ensure that each contact position can be inspected easily from the floor level. Each section shall have plug-in modules or easily removable connection pieces to allow for easy replacement of any component with the minimum of disturbance to the remainder of the equipment.

The number of transport/shipping splits shall be minimized to keep installation time of GIS to a minimum.

The arrangement shall afford maximum flexibility for routine maintenance. Equipment removal and SF6 handling should be accomplished with ease.

The ease of operation shall be ensured.

*In general the contours of energized metal parts of the GIS and any other accessory shall be such as to eliminate areas or points of high electrostatic flux concentrations. Surfaces shall be smooth with no projection or irregularities, which may cause corona.*

### **1.2.2 Modular Design & Future extensions**

The GIS switch gear shall be of modular design offering high degree of flexibility. Each module shall be complete with SF6 gas circuit breaker, Disconnectors, Maintenance Grounding switches, fast Earthing switches, Voltage transformers, Current transformers, bus & elbow sections, cable end enclosures, L.A., local control cubicle and all necessary components required for safe & reliable operation and maintenance. All the three phases of the busbars and associated equipments like breakers, disconnectors, instrument transformers & earthing switches etc., as detailed in enclosed single line diagram are to be encapsulated in a single gas filled metallic enclosure.

The bus bars shall be sub-divided into compartments including the associated bus bar disconnector. *Bus bars are partitioned at each bay with an objective to isolate Busbar compartment for the purpose of extension and at the same time avoid damage to adjacent bays in the event of fault.*

**1.2.2.1 Materials used in the manufacture of the switchgear equipment shall be of the type, composition and physical properties best suited to their particular purposes and in accordance with the latest engineering practices.**

**1.2.2.2 The switchgear shall be of the freestanding, self-supporting dead-front design, with all high-voltage equipment installed inside gas-insulated, metallic grounded enclosures, and suitably sub-divided into individual arc and gas-proof compartments.**

1.2.2.3 Arc faults caused by external reasons shall be positively confined to the originating compartment and shall not spread to other parts of the switchgear. In case of any internal arc fault in a busbar, busbar disconnector or circuit breaker, of double bus system, repair works must be possible without shutting down complete substation and at least one busbar and the undisturbed bays must remain in operation.

Where bus Coupler / sectionaliser is specified and in case of any internal arc fault in a busbar, busbar disconnector or sectionaliser, repair work must be possible without shutting down the complete substation and at least one half of the substation must remain in operation. Documents indicating sequence

of repair work steps and description of necessary restrictions during work shall be submitted with the technical bid.

Each bay module should be equipped with suitable arrangement for easy dismantling and refitting during maintenance without disturbing other units.

**1.2.2.4 The maximum temperature in any part of the equipment at specified rating shall not exceed the permissible limits as stipulated in the relevant standards.**

**1.2.2.5 There shall not be any kind of interference to the connected & nearby equipment and system, when the equipment is operated at maximum service voltage.**

### **1.2.3 Maintenance and repair of a circuit breaker**

The positioning of the circuit breaker in the GIS shall be such that it shall be possible to access the circuit breaker of any feeder from the front side for **routine inspection**, maintenance and repair without interfering with the operation of the adjacent feeders.

*The GIS shall be so designed that any component of the GIS can be removed easily. With minimum flexibility in the layout arrangement it shall be possible to remove the circuit breaker with both busbars remaining in service and it shall be possible to remove the disconnecter of the busbars, with one bus bar remaining in service.*

### **1.2.4 Interchangeability**

As much as possible, all the parts shall be of standard manufacture with similar parts and assemblies being interchangeable.

### **1.2.5 Future Extension**

The modular design of GIS switch gear shall be capable of extension in the future **on either end** by the addition of extra feeders, bus couplers, busbars, circuit breakers, Disconnectors, and other switch gear components without **drilling, cutting, welding or** dismantling any major part of the equipment. The Vendor is required to demonstrate clearly in his submitted documents the suitability of the switchgear design in this respect. **The arrangement shall be such that expansion of the original installation can be accomplished with minimum GIS down time. In case of extension, the interface shall incorporate facilities for installation and testing of extension to limit the part of the existing GIS to be re-tested and to allow for connection to the existing GIS without further dielectric testing.**

1.2.6 The SF6 GIS shall be of **INDOOR** type and suitable for the atmosphere of the location which is heavily polluted, windy, sandy desert & **service condition indicated at 2.1.**

1.2.7 The required switchgear shall be capable of being supplied in a completely gas-insulated version in which case all switchgear components including the bus-bars shall be of gas-insulated type.

### 1.3 Specification requirements

The 66 kV GIS switch-gear shall be of a **Double** bus design having three-phase common enclosure concept, and it shall consist of Line & transformer bays as indicated in attached Single line Diagram and General lay out plan. This configuration shall meet within the given area indicated in layout plan.

### 1.4 Current Rating

The current rating of the switchgear should be assessed on the following requirements-

- a) Capable of handling power to an extent of as to an ambient day-time mean temperature between – 5 deg C and + 50 deg C
- b) The switchgear described in this specification is intended for continuous duty at the specified ratings and under **all system operating conditions including sudden change of load and voltage within its ratings and at specified** ambient conditions 24 hours a day, 365 days a year unless indicated otherwise.

The installed capacity of the power transformers is given in SLD attached.

### 1.5 Electrical, Mechanical and Thermal Capability

The assembled equipment shall be capable of withstanding the electrical, mechanical and thermal ratings of the specified system. All joints and connections shall be required to withstand the forces of expansion, vibration, contraction, and specified seismic requirements without deformation or malfunction *and leakage*. The apparatus shall be capable of withstanding the specified environment.

### 1.6 Insulation level

The switchgear and other equipment shall be designed for a maximum operating voltage and rated impulse withstand voltage according as specified in cl. 2.3. The switchgear may require to be installed in an unmanned distribution network with predominantly over head interconnection or EHV cable as the case may be. Circuit breakers shall be capable of interrupting line, transformer & cable charging currents of the magnitude indicated in the data schedules.

### 1.7 Physical arrangement

- a) The layout shall be properly designed by the bidder to completely accommodate the present & future requirements of the substation as per the furnished single line diagram and the enclosed site plan. They may be adjusted as necessary to suit the manufacturer's standard design and Utility need.
- b) The arrangement of the switchgear offered must provide adequate access for checking and maintenance.
- c) *Optimized arrangements are required so as to reduce installation time, minimize maintenance & repair cost, provide ease of operation and facilitate future expansions.*

### 1.8 Gas Sectionalisation

- a) The switch-gear gas enclosures must be sectionlised, with gas tight barriers between sections or compartments.
- b) The sections shall be so designed as to minimize the extent of plant rendered inoperative when gas pressure is reduced, ether by excessive leakage or for maintenance purposes, and to minimize the quantity of gas that has to be evacuated and then recharged before and after maintaining any item of equipment.
- c) The arrangement of gas sections or compartments shall be such that it is possible to extend existing bus-bars without having to take out of service another section of the bus-bar at a time.
- d) For limitation of any internal arc to the concerned bay and to reduce the extent of necessary gas works of each section of the bus-bar must be sectionalized bay by bay.
- e) ***Sectionalisation shall ensure that circuit breaker enclosure will not include any other equipment in its gas compartment.***

### 1.9 Expansion Joints and Flexible Connections

- a) The layout shall sufficiently take care to the thermal expansion / contraction of the assembly by the provision of expansion joints. Expansion joints shall be placed in between any bay section of the busbar. **All joint surfaces shall be machined, and all castings shall be spot faced for all bolt heads or nuts and washers.**
- b) If necessary, the number and position of expansion joints or flexible connections are to be determined by the manufacturer to ensure that the complete installation will not be subject to any expansion stresses which could lead to distortion or premature failure of any piece of the SF6 equipment, support structures or foundations.

**Bracing shall be provided for all mechanical components against the effects of short circuit currents specified under system parameter. The design of the equipment shall be such that the agreed permitted movement of foundations or thermal effects does not impair the assigned performance of the equipment.**

**The design calculations for all the supports shall be submitted to ensure care taken.**

- c) The continuity of service during thermal expansion / contraction and vibrations shall be ensured. Expansion joints, flexible connections and adjustable mountings shall be provided to compensate for reasonable manufacturing and construction tolerances in the associated equipment to which the GIS may be connected. ***Required sliding plug-in contacts for conductors shall be provided.*** This is to ensure that unreasonably excessive accuracy is not required when installing such equipment and constructing the associated foundations or support structures, e.g. transformers or the interconnection of isolated sections of switch-gear by means of long GIS bus-bar or duct installations. Flexible joints may also be provided to allow more efficient maintenance and future extensions of the GIS.

### 1.10 Barrier and Non-Barrier Insulators

- a) Support insulators shall be used to maintain the conductors and enclosure in proper relation. These support insulators may be of two types. Barrier insulators which are employed to isolate gas compartments and non-barrier insulators which allow the gas pressure to equalize.
- b) The gas barrier insulators sealing to the conductors and the enclosure wall shall be designed to withstand the maximum pressure difference that could occur across the barrier, i.e. maximum operating pressure at one side while a vacuum is drawn at the other side & in case of internal arc fault with a safety factor of 2.
- c) The support insulators and section barriers / insulators shall be manufactured from the highest quality material. They shall be free from all voids and the design shall be such as to reduce the electrical stresses in the insulators to a minimum. They shall also be of sufficient strength to ensure that the conductor spacing and clearances are maintained when short circuit faults occurs.
- d) Tests shall be carried out during the manufacture of the Switchgear to ensure that all parts of the equipment are free of partial discharge with a partial discharge extinction voltage which is at least 10% higher than the rated voltage.

### 1.11 Gas seals, Gas Density & pressure and other requirements.

- a) Single sealing of O-ring type shall be used for sealing the connections between the switch-gear modules. The leakage rates shall be kept to an absolute minimum under all normal pressure, temperature, electrical load and fault conditions. The guaranteed leakage rate of each individual gas compartment **and between compartments** must be less than **0.5% p.a. for the service life of equipment**.
- b) Piping and fittings for gas monitoring and gas supply shall be made of copper or brass. The gas monitor device should be installed at each individual compartment of the module. Each gas compartment must be independent, external gas pipe connections should be avoided to minimize leakage.
- c) All gas compartments shall be fitted with filter material which absorbs the residual moisture and moisture entering inside the High-voltage enclosure. Filters in gas compartments with switching devices must also be capable to absorb the gas decomposition products resulting from the switching arc.
- d) The rated pressure of the SF<sub>6</sub> insulating gas in the metal-clad equipment shall be as low as is compatible with the requirements for electrical insulation and space limitations to reduce the effects of leaks.
- e) The SF<sub>6</sub> switch-gear shall be designed for use with SF<sub>6</sub> gas complying with the recommendations of IEC – 60376 at the time of the first charging with gas.
- f) *Connections including bolts and nuts shall be adequately protected from corrosion and easily accessible with the proper tools.*
- g) *All components shall be fire retardant and shall be tested in accordance with relevant standards. Gas emissivity when the Material is heated shall be minimal.*

### 1.12 Gas Treatment Requirements

Under normal operating conditions it shall not be necessary to treat the insulating SF6 gas between major overhauls. In all gas compartments permanent efficient filters and desiccants shall be effective for the duration of time between major overhauls. Notwithstanding this, the insulators in the circuit breaker shall be made of epoxy resin composition that will resist decomposition products in contact with moisture.

### **1.13 Gas Monitoring Devices**

Gas density or pressure monitoring devices shall be provided for each gas compartment. The devices shall provide continuous and automatic monitoring of the state of the gas. The *SF6 gas* monitoring device shall have two *supervision and* alarm settings. These shall be set so that, an advanced warning can be given that the gas density/pressure is reducing to an unacceptable level. After an urgent alarm, operative measures can be taken to immediately isolate the particular compartment electrically by tripping circuit breakers and opening disconnectors. ***It shall be ensured that there is no chance of the gas liquefying at the lowest ambient temperature.***

*The gas monitoring device shall monitor at least the following, locally and on remote.*

- i) "Gas Refill" Level- This will be used to annunciate the need for gas refilling.*
- ii) "Breaker Block" Level- This is the minimum gas density at which the manufacturer will guarantee the rated fault interrupting capability of the breaker. At this level the device contact shall trip the breaker and block the closing circuits.*
- iii) Over pressure alarm level- This alarm level shall be provided to indicate abnormal pressure rise in the gas compartment.*

*It shall be possible to test all gas monitoring relays without de-energizing the primary equipment and without reducing pressure in the main section. Disconnecting type plugs and sockets shall be used for test purposes; the pressure/density device shall be suitable for connecting to the male portion of the plug.*

*Two potential free electrical contacts shall be provided with each and every alarm condition.*

### **1.14 Conductors**

The conductors shall be made of aluminum alloy suitable for specified voltage and current ratings. ***The electrical connections between the various gas sections shall be made by means of multiple contact connectors (plug-in type) so that electrical connection is automatically achieved when bolting one section to another. Field welding of conductor is not acceptable. The surface of the connector fingers and conductor on such connections shall be silver plated.*** Both, the conductors as well as the contacts for the conductor connections must be designed for the continuous rated current of the switch

gear under the ambient conditions furnished, and shall not exceed the permissible temperature rise.

### **1.15 Enclosures**

**1.15.1** The metal enclosures for the SF6 gas insulated equipment modules shall be made from Aluminum alloy. Suitable anti corrosive paints shade 631 of IS:5, must be applied on the exterior of the enclosures. The enclosure shall be suitable for three phases, i.e. Single Enclosure. The external fixtures should be made of corrosion-resistant material and should be capped where required.

Bellow compensators shall be made of Stainless steel to preserve the mechanical strength of the equipment at the connection portions to deal with the following problems:

- a) Expansion and Contraction of outer enclosure and conductor due to temperature variations.
- b) Mismatch in various components of GIS
- c) Vibration of the transformer and switching equipment
- d) Dimensional variations due to uneven settling of foundation
- e) Seismic forces as mentioned in climatic condition.

1.15.2 Standard paint **shade 631 of IS:5** shall be used with satin mat finish having high scratch resistance.

1.15.3 The gas-filled enclosures shall conform to the pressure vessel code applied in the country of manufacturer. Gas section barriers including seals to the conductor and enclosure wall shall be gas-tight and shall be capable of withstanding the maximum pressure differential that could occur across the barrier, i.e., with a vacuum drawn on the one side of the barrier and on the other side, at least the maximum gas pressure that can exist under normal operating or maintenance conditions and in case of internal arc fault.

The finish of interior surfaces of the metal-clad enclosures shall facilitate cleaning and inspection. **High quality primer followed by two coats of anti corrosive paint of glossy white shade** shall be used such that they will not deteriorate when exposed to the SF6 gas and other vapors, Arc products, etc., which may present in the enclosures. They shall also not contain any substances which could contaminate the enclosed gas or affect its insulating properties over a period of time.

### **1.16 General Finish and Cleaning**

- a) The equipment shall be manufactured and assembled at the manufacturer's works under conditions of the utmost cleanliness.
- b) Very dusty / sandy conditions may exist at the site hence, whenever possible, the complete feeders or major assembly of components should be shipped as transport units. Before the metal clad enclosed sections are joined together and charged with the SF6 gas they must be thoroughly cleaned.



- c) Paints shall be carefully selected to withstand heat and weather conditions. The paint shall not scale-off or crinkles or gets removed by abrasion due to normal handling.
- d) Sufficient quantities of all paints and preservatives required for touching up at sites shall be furnished with GIS.

**1.17 Gas filling and Evacuating Plant/Gas reclaimer for 66 kV GIS unit.**

- a) All apparatus necessary for filling, evacuating, and recycling the SF<sub>6</sub> gas into and from the switch-gear equipment shall be supplied by the bidder to enable any maintenance work to be carried out.
- b) Where any item of the filling and evacuating apparatus is of such a weight that it cannot easily be carried by maintenance personnel, it shall be provided with facilities for lifting and moving with the overhead cranes.
- c) The apparatus for filling, evacuating and recycling all gases to be used shall be provided with all necessary pipes, couplings flexible hoses, tubes and valves for coupling to the switch-gear equipment.
- d) The gas compartments shall preferably be fitted with permanent vacuum couplings through which the gas is pumped into or evacuated from the compartments.
- e) Details of the filling and evacuating apparatus that will be supplied, and also a description of the filling, evacuating and recycling procedures, shall be provided with the bid.
- f) The initial gas filling of the entire switch-gear including the usual losses during commissioning shall be supplied over and above the required quantity of spare gas.
- g) An additional quantity of SF<sub>6</sub> gas for compensation of possible losses during installation and 10% extra quantity of SF<sub>6</sub> gas for future uses shall be supplied. The quantity of the same shall be indicated in GTP.

Such spare gas shall be supplied in sealed cylinders of uniform size, which shall be decided during detailed engineering.

- h) Gas reclaimer shall have gas storage facility of sufficient capacity.
- i) SF<sub>6</sub> Gas Processing Unit :
  - A. An SF<sub>6</sub> gas-processing unit suitable for evacuating, liquefying, evaporating, filling, drying and purifying SF<sub>6</sub> gas during the initial installation, subsequent maintenance and future extension of GIS shall be provided. The cart shall be equipped with rubber wheels and shall be easily maneuverable within the GIS building.
  - B. A wheeled maintenance unit shall be supplied which shall be self-contained (except for additional gas storage bottles and external power supply at 415 V AC, 3-phase, 50 Hz) and fully equipped with an electric vacuum pump, gas compressor, gas drier, gas filter, refrigeration unit, evaporator, gas storage tank, full instrumentation for measuring

vacuum, compressor inlet temperature, tank pressure and temperature, valving and piping to perform the following operations as a minimum requirement:

- i) Evacuation from a gas filled compartment using the vacuum pump,
  - ii) Transfer of SF<sub>6</sub> gas from a system at some positive or negative pressure to the storage tank via the gas drier and filter;
  - iii) Recirculation of SF<sub>6</sub> gas in the storage tank through the drier,
  - iv) Recirculation of SF<sub>6</sub> gas in any switchgear or bus duct compartment through the drier and filter;
  - v) Evaporating and filling SF<sub>6</sub> gas,
  - vi) Drawing off and liquefying SF<sub>6</sub> gas,
  - vii) A combination operation of filling SF<sub>6</sub> gas into a gas system and evacuating a second gas system using the vacuum pump.
- C. Adequate length of hoses with necessary adaptors shall be provided for filling of SF<sub>6</sub> gas in any of the gas compartment with the help of gas cart.
- D. GA drawing and Schematic drawing for gas processing unit shall be submitted for approval.

### **1.18 Support Structures**

All supporting structures necessary for the support of the GIS equipment including associated parts such as anchor bolts, beams etc. shall be supplied. Sufficient attachment points to the apparatus and concrete foundations shall be furnished to ensure successful installation, with required clearances, while taking into account thermal expansion and contraction. Earthquake requirements are also to be considered.

Any scaffolding or a movable platform, required for maintenance, shall also be supplied.

All steel structure members shall be hot-dip galvanized after fabrication. Minimum thickness of Galvanizing shall be 610 grams per square meter. All field assembly joints shall be bolted. Field welding shall not be acceptable.

Non-corrosive metal or plated steel shall be used for bolts and nuts throughout the work. Manufacturer shall provide suitable foundation channels and anchor bolts to support the switchgear assemblies. All mounting bolts, nuts and washers shall be provided to fasten the switchgear base frames to the foundation channels.

Foundation channels and anchor bolts shall be installed in the civil works in accordance with instructions provided by the manufacturer.

### **1.19 Auxiliary Equipment**

The following items shall be included for a complete installation:

- a) Control system including local control cabinets
- b) Cable and wiring between individual items of supplied equipment.
- c) Nameplates
- d) All ladders, platforms, stairs, walkways, and supports necessary to operate and maintain all equipment safely and efficiently.
- e) Special tools and tackles for installation
- f) Special tools and tackles for maintenance

### 1.20 Safety Precautions

1 The switch-gear must provide a maximum degree of safety for the operators and others in the vicinity of the switch gear under all normal and fault conditions. The safety clearances of all live parts of the equipment shall be as per relevant standards.

2 It must be made impossible to touch any live part of the switch-gear unwillingly, i.e. without use of tools or brute force.

3 An operator standing in the normal operating position should not be endangered by any moving external part of the switch-gear.

#### 4 Interlocks:

Mechanical & electrical interlocks must be provided to ensure absolute and reliable protection against potentially harmful Mal-operation of the switchgear. All interlocks that prevent potentially dangerous mal-operations shall be so constructed such that they cannot be defeated easily i.e. the operator must use tools and/or technique to over-ride them only in case of emergency.

The following functions shall be provided:

- 1) The operator must be forced in to the only safe and logical sequence to actuate the circuit breakers, disconnectors & earthing switches.
- 2) The actual, completely closed or completely opened position of all switching devices must be checked before and after each move.
- 3) Implementation of logic checks and issuing the resultant signals Enabled or Blocked for the switching device.

5 If in spite of all possible safety measures if any arc occurs, the following is required.

- i) The effects of an internal arcing fault must be limited to the related gas compartment.
- ii) Each gas compartment must have its own **automated external** pressure relief device to provide instant and safe discharge of accidental overpressure during internal arc. Rupture diaphragms shall be preferably used as pressure relief mechanisms. **The bursting pressure of relief device should be effectively coordinated with the rated gas pressure and the pressure rise due to arcing.** PRD shall be positioned such that it will not be below any circuit breaker or disconnector drive or LCC.
- iii) All earthing connections must remain operational.

iv) The enclosure of the switch gear must withstand the thermal effects of an arc at the full rated short circuit current until the nearest protective relay has acted and tripped the breaker.

v) To limit the effects of an internal arc the switch gear shall be suitably subdivided into individual arc and gas-proof compartments, at least for

- Bus-bar together with bus-bar isolator and earthing switch
- Circuit breaker
- Line isolators and earthing switch, (Line, transformer)
- Instrument transformers.

6 The following requirements are to be followed.

- i) The bracing/welding of all components subject to mechanical forces caused by short circuit currents shall be capable so as to withstand the effects of at least 2.5 times the rated symmetrical short time withstand current.
- ii) The thermal rating for all current carrying parts and insulating materials shall be a minimum of three seconds for the rated short time withstand current.
- iii) All components of the switch gear which are on ground potential shall be electrically inter-connected and effectively earthed.

### **1.21 Special tools, tackles and equipments**

Special tools, tackles and equipment that are required to perform installation, commissioning, operation & maintenance of the gas insulated switch gear shall be included in scope of supply. *Minimum following tools shall be supplied.*

- 1 Dew point measurement meter
- 2 SF6 gas leakage detector
- 3 Precision pressure gauge
- 4 Gas-service carts
- 5 Any other special tool/tackle required.

**The tools shall be shipped in separate containers, clearly marked with the name of the equipment for which they are intended.**

*The requirement of HV testing during commissioning or repairing or replacement shall be fulfilled by successful bidder by arranging the required HV testing equipment at no extra cost to Utility. No delay shall be permitted on account of the non availability of the HV test equipments.*

### **1.22 Grounding of GIS:**

- a) GIS will be housed on GIS floor. The bidder will provide under-ground mat below the substation. The bidder shall also provide adequate number of Galvanized steel risers to be connected to grounding mat, as per relevant standards and in consultation with Utility during detailed engineering, in the event of an order.

- b) The bidder shall supply entire material for ground bus of GIS such as conductor, clamps, joints, operating and safety platforms etc. to be laid / embedded in GIS floors. The bidder is also required to supply all grounding connectors and associated hardware material for:
  - i) Connecting all GIS equipment, Bus duct, enclosures, control cabinets, supporting structures etc. to the ground bus of GIS
  - ii) Connecting ground bus of GIS to the ground mat risers.
- c) The grounding arrangement of GIS shall ensure that touch and step voltages are limited to safe values as per IEEE std. 80-2000. The enclosures of the GIS shall be grounded at several points such that there shall be a grounded cage around all live parts. The ground continuity between each enclosure shall be affected over flanges, with or without links or straps to bridge the flanges. Copper/Aluminum straps shall however bridge the metallic expansion bellows. *The grounding switches shall be connected to ground through the enclosure. Individual ground leads for the ground switches are not allowed. The inductive voltage against ground in each part of the enclosure shall not be more than 65 Volts.*
- d) Where operating mechanism cabinets are mounted on the switchgear, the grounding shall be made by separate conductor. Bay control cabinets shall be grounded through a separate conductor.
- e) All conduits and control cable sheaths shall be connected to the control cabinet grounding bus. All steel structures shall be grounded.
- f) Each removable section of catwalk shall be bolted to the support structure for ground continuity.
- g) The enclosure grounding system shall be designed to minimize circulating currents and to ensure that the potential rise during an external or internal fault is kept to an acceptable level. The guidelines of IEEE Std. 80-2000 on GIS grounding, especially the transient ground potential rise caused by high frequency phenomena, shall be taken into consideration while designing the grounding system for GIS.
- h) The manufacturer shall furnish readily accessible connectors of sufficient mechanical strength to withstand electromagnetic forces as well as capable of carrying the anticipated maximum fault current without overheating by at least from two paths to ground from the main ground bus.
- i) Provisions of IEC 517 & 694 regarding safeguards in grounding of connected cables, testing during maintenance and other safety measures shall be ensured.
- j) *Earthing conductors shall be designed to allow flow of short circuit current. Conductors with copper bars are preferred over copper wires.*

## 2.0 Service Conditions:

### 2.1 Climatic Conditions:

The equipment and the accessories to be supplied against this technical specification shall be suitable for satisfactory continuous operation under the following tropical conditions (to be customized by utility as per requirement).

Max ambient temperature	50 deg C
Min. ambient temperature	-5 deg C
Max daily average ambient	38 deg C
Max relative Humidity (%)	As per IEC
Max altitude above M.S.L (meters)	< 1000
Average Annual Rainfall (mm)	1000
Max wind pressure (kg./sq.mtr.)	130
Isoceraunic level (days/yr)	50
Average no. of rainy days / annum	120
Condensation	Occasional
Induced electromagnetic	1.6 kV
Pollution class / Creepage distance	III / 25 mm/kV
Seismic Zone	Zone V
Acceleration due to gravity, g	0.5

## 2.2 System Particulars

### 2.2.1 Pole designation

#### 2.2.1.1

##### Enclosure

2.2.1.1.1 Bus bar : Three Phase

2.2.1.1.2 Bay : Three Phase

2.2.1.1.3 Enclosure material : Aluminum Alloy

#### 2.2.2 Standards

Common clauses for high voltage switchgear : IEC 60694  
& control gear

High voltage metal enclosed switchgear for : IEC 62271-203  
72.5 KV & above

Specification for acceptance of new Sulphur : IEC 60376

Hexa fluoride

Guide to checking of Sulphur Hexa fluoride : IEC 60480  
taken from Electrical equipment

*Surge Arresters* : IEC 60099

Overhead line, Cable and Transformer Terminals : IEC 60137  
Bushings for alternating voltages above 1000 V

Cable connections for gas insulated metal : IEC 60859  
enclosed Switchgear for rated voltages of 72.5 KV above

*High voltage test techniques* : IEC 60060

*Insulation coordination* : IEC 60071

*Electrical Relays* : IEC 60255

*High voltage switches* : IEC 60265

*Partial discharge measurement* : IEC 60270

*Degree of protection* : IEC 60529

*Pollution levels* : IEC 60815

*EMC* : IEC 61000

*Use and handling of SF6 gas* : IEC 61634

*Standards for station grounding* : IEC 60364/ 60479/  
IEEE 80

*Pressure vessel code* : CENELEC/ SVDB

*Recommendation for heat treated Aluminum alloy busbar material of the aluminum-magnesium-silicon type* : IEC 60114

**IEEE Guide for Gas-Insulated Substations** : IEEE std C37.122.1-1993

**Seismic design** : IEC 693

### 2.2.3.1 Instrument Transformers

Instrument transformers : IEC 60044

Current transformer : IEC 60185

Voltage transformer : IEC 60186

### 2.2.3.2 Circuit Breaker

High voltage Alternating current circuit breakers : IEC 62271-100

Report on Synthetic testing of high voltage : IEC 60427  
 Alternating Current Circuit breakers

#### 2.2.4 Disconnectors and earthing switch

Alternating current Disconnectors (isolators) : IEC 60129  
 and earthing Switch IEC 62271-102

Alternating current disconnectors, Bus : IEC 61128  
 transfer current Switching by disconnectors

Alternating current earthing switches, : IEC 61129  
 induced current Switching

2.2.5 *Artificial pollution test on HV* : *IEC 60507*  
*insulators to be used on ac system*

2.2.6 *Gas insulated metal enclosed switchgear* : *IEC 60517*  
*for rated voltages of 72.5 kV and above*

2.2.7 *Classification of degree of protection* : *IEC 60529*  
*provided by enclosures*

**2.3 Electrical data:** ((To be customized by utility as per requirements & capacity)

Rated System Voltage / Highest System/Equipment Voltage	kV	66 / 72.5
One min. Power frequency withstand voltage	kV rms	140
Across open isolator	kV rms	160
Across the open gaps of CB	kV rms	140
Rated Lightning Impulse withstand voltage (1.2/50 micro second peak value)		
Phase to phase	kVp	350
Phase to earth	kVp	350
Across open isolator	kVp	375
Across the open gaps of CB	kVp	350
Rated Frequency	Hz	50
Rated Continuous current at 40 deg C ambient temperature Bus bar	Amps	1600
Feeder and Transformer Bay	Amps	1600
Rated Short circuit Withstand current for 3 seconds	kA	25
Rated dynamic withstand current	kAp	62.5
Partial Discharge (at 1.1 Un)	pico-coulombs	5(max.)
System Neutral earthing		Solidly earth



Maximum SF6 Gas leakage rate per year	% per year	0.5
---------------------------------------	------------	-----

### 2.3.1 Auxiliary Supply:

For Operation, control and signaling : 110 Volts DC (+10% & -20%) or as reqd by utility

For other loads : 440 / 230 Volts, AC 50 Hz.  
(+10% & -15%)

## 2.4 Seismic requirements:

**The GIS shall comply with IEEE STD 693 – 1984 guideline to ensure functional adequacy under seismic disturbances. The maximum ground acceleration shall be 0.5 g.**

## 3 Detailed technical requirements for GIS Components

### 3.1 Circuit Breaker:

#### 3.1.1 General:

3.1.1.1 The GIS circuit breakers shall comply with the following general requirements for circuit breakers and the latest revisions of the relevant **IEC-62271-100** specifications

3.1.1.2 Circuit-breakers shall be of single pressure, single break, **self** compression **self blast** / auto puffer type with SF6 as arc quenching & insulation medium and with a minimum- maintenance contact system

3.1.1.3 They shall be of three phase encapsulated type.

3.1.1.4 Ratings of the circuit breaker shall be as per enclosed technical parameters

3.1.1.5 They should be shipped as a completed three-phase unit within a complete bay module.

3.1.1.6 Each circuit-breaker shall have spring/*Hydraulic*/combined drive mechanism **ensuring proper closing and opening, and shall permit checking of adjustments and opening/closing characteristic.** The ON/OFF latches shall be mechanically interlocked with each other. The circuit breaker shall be completely factory assembled, adjusted and tested.

3.1.1.7 The total break time from energizing the trip coil at rated control voltage to final arc extinction shall be as short as possible, but in any event not greater than 3 cycles i.e. 60 ms.

3.1.1.8 The circuit breaker shall be capable of breaking all currents from zero up to the specified maximum fault current in accordance with the relevant IEC recommendations.

3.1.1.9 The breakers are to be restrike-free.

3.1.1.10 The circuit-breakers shall be capable of tripping and re-closing (Auto reclose) according to the specified duty cycle without derating: O-0.3 s – CO – 3 min. – CO.

**Breaker shall be suitable for following switching duties:**

|| **Terminal faults**

|| **Short line faults**

|| **Out of phase switching**

|| **Interruption of small inductive current including transformer**

|| **magnetizing inrush currents.**

|| **Interruption of line and cable charging currents.**

**The circuit breaker shall meet all the double Circuit overhead transmission line and cable characteristics for any type of fault or fault location, and also for line charging and dropping when used on an effectively grounded system. Effect of second circuit in parallel shall also be considered.**

**The circuit breakers shall be capable of being operated locally or from remote. Local operation shall be by means of an open/close control switch located in the bay control cabinet.**

**The minimum guaranteed nos. of maintenance free operations of complete GIS shall be 10000 nos. at rated capacity.**

3.1.1.11 The Drive shall have sufficient stored energy for completing 2 CO with auxiliary power switched off.

3.1.1.12 Circuit breakers, being an arcing device, shall not house any passive device like current transformer in its housing.

***3.1.1.13 The breaker layout arrangement shall be vertical or horizontal but shall provide higher mechanical stability and ease in maintenance. The operating principle of the breaker shall ensure minimized dynamic floor loading. Low reaction forces on foundations especially dynamically, are favorable and considered in the elevation.***

### **3.1.2 Closing Devices**

3.1.2.1 The closing coils shall be suitable for operation at any voltage between 110% and 80% of the nominal control voltage measured at the device terminals.

3.1.2.2 The breaker shall close correctly when an electrical closing pulse of 50 msec. duration is applied to the closing coil.

### **3.1.3 Tripping Devices**

3.1.3.1 All electrical tripping coils shall be suitable for operation at any voltage between 110% and 70% of the nominal control voltage measured at the device terminals.

3.1.3.2 Each circuit-breaker shall be equipped with two shunt trip system. The one shunt trip system shall be electrically separated from the other system.

3.1.3.3 An emergency hand tripping (mechanical) device shall be provided in the operating mechanism.

### 3.1.4 Anti-Pumping

The circuit-breaker mechanism shall be provided with means to prevent pumping while the closing circuit remains energized, should the circuit breaker either fail to latch, or be tripped during closing due to the operation of the protective relays.

### 3.1.5 Operating Mechanism

3.1.5.1 The breaker **shall include suitable** spring/*Hydraulic*/combined operating mechanism to assure proper opening & closing operations. The provision shall be made for checking adjustments and opening characteristics. The mechanism shall be capable of re-closing within the range specified in the applicable standards. The mechanism shall include dual trip coils. ***Charging of opening mechanism shall be possible in the event of failure of the motor drive.***

#### *Spring Operated Mechanism*

*a) Spring operated mechanism shall be complete with motor, opening spring, closing spring with limit switch for automatic charging and all necessary accessories to make the mechanism a complete operating unit.*

*b) As long as power is available to the motor, a continuous sequence of closing and opening operations shall be possible.*

*c) After failure of power supply to the motor, at least two close-open (C-O) operations of the circuit breaker shall be possible.*

*d) Breaker operation shall be independent of the motor which shall be used solely for compressing the closing spring.*

*e) Motor rating shall be such that it requires only about 30 seconds for fully charging the closing spring.*

*f) Closing action of the circuit breaker shall compress the opening spring ready for tripping.*

*g) When closing springs are discharged after closing a breaker, closing springs shall automatically be charged for the next operation.*

#### ***Hydraulic Operated Mechanism***

*a) Hydraulic operated mechanism shall comprise self contained operating unit with power cylinder, control valves, high and low pressure reservoir, motor, etc. A hand pump set shall also be provided for emergency operation.*

*b) The oil pressure controlling the oil pump and pressure in the high pressure reservoir shall be continuously monitored. Necessary hardware to achieve this,*

*including the loose pressure gauge, instruments and interconnecting piping etc shall form integral part of this mechanism.*

*c) The mechanism shall be suitable for at least two close-open operations after failure of AC supply to the motor.*

3.1.5.2 The mechanism shall be in a dust proof (**IP55**) box for this outdoor installation of Gas Insulated Switchgear.

One vermin-proof, sheet steel cabinet of adequate size shall be provided for housing the operating mechanism, aux relays, control and auxiliary equipment and for terminating all control, alarm and auxiliary circuits in suitable terminal boxes. The control cabinet shall be provided with hinged doors with provision for locking and removable cable gland plates for bottom cable entry. Viewing windows shall be provided for observation of the instruments without opening the cabinet. Suitably engraved nameplates shall be provided to identify all equipment in the control cabinet.

### **3.1.6 Auxiliary Switches**

Each breaker shall have auxiliary switches with adequate number of NO and NC contacts all wired to terminals located in the local control cabinet of the circuit breaker bay. 20 % spare contacts should be provided.

### **3.1.7 Indicating Devices**

3.1.7.1 Position indicators shall be provided to clearly indicate whether a circuit-breaker is open or closed.

3.1.7.2 Each circuit-breaker shall be provided with an operation counter to record the number of tripping operations performed. The counter may be located at the local control cabinet.

3.1.7.3 All position indicators and counters shall be readable at a convenient elevation i.e. from the place of operation.

### **3.1.8 Gas Connections**

Necessary valves and connections shall be provided to assure ease in handling the SF<sub>6</sub> gas.

### **3.1.9 Timing Test**

Timing tests are to be carried out after the switch gear has been completely charged with SF<sub>6</sub> gas.

#### *3.1.9.1 Testing instruments*

- \_ Air / gas humidity tester,*
- \_ Gas purity detector for SO<sub>2</sub>, H<sub>2</sub>O, CF<sub>4</sub>, AIR etc.,*
- \_ Gas leakage tester,*
- \_ Breaker timing measurement kit,*
- \_ Set of equipment for pressure measurement and gas density meter.*

#### 3.1.9.2 TESTING FACILITIES:

Timing test facility shall be provided with switchgear such that it is not necessary to open up any gas section to make test connections to the circuit breaker terminals. All details of test facilities to be provided shall be submitted with technical bid.

### 3.1.10 Principle Parameters

The Circuit Breakers of GIS equipment shall confirm to the specific technical requirements given as under.

**Circuit Breaker** (To be customized by utility as per requirements & capacity)

S. No	Particulars	66 kV
1a)	Enclosure	Three Phase
1b)	Enclosure material	Aluminum Alloy
2)	Rated voltage	72.5 kV
3)	Rated current	1600A
4)	Rated frequency	50 Hz
5)	Rated short-circuit breaking current	25 kA rms, 3 sec
6)	Rated break-time	3 cycle
7)	Rated short-circuit making current	62.5 kA peak
8)	Difference for simultaneity of 3 poles	4 ms (Max.)
9)	Rated insulation level under minimum SF6 gas pressure	
a)	Power frequency withstand voltage	140 kV rms
b)	Lighting impulse withstand voltage	350 kV peak
c)	Rated operating sequence	O-0.3s-CO-3min-CO
10)	Type of operating mechanism for circuit Breaker	Spring – Spring/hydraulic
11)	Rated control voltage	

	- Closing coil	110/220 VDC 110/220 VDC
	- Tripping coil	
12)	Mechanical Endurance class	M1
13)	Electrical Endurance class	E1
14)	Restriking probability class	C1
15)	Rated line charging breaking current	10:00 AM
16)	Rated cable charging breaking current	125 A
17)	Rated capacitor bank switching current	410 A
18)	Rated out of phase making and breaking current in % of rated short circuit breaking current	25
19)	Characteristic for short line fault related to rated short circuit breaking current	As per IEC 62271 - 100
20)	TRV characteristics	As per IEC 62271 - 100
21)	Inductive current breaking capability	Switching No Load current of transformer
22)	First pole to clear factor	As per IEC 62271 - 100
23)	Opening time in ms	Not more than 40
24)	Closing time in ms	Not more than 100
25)	Noise level at the base of CB	As per NEMA standard
26)	No of tripping coils per breaker	2
27)	No of closing coils per breaker	1

### 3.2 Disconnecter Switches and Maintenance Grounding switches

#### 3.2.1 General

- a) The GIS disconnect switches and grounding switches shall comply with the following general requirements of disconnect switches and the latest version of the relevant specifications IEC 60129, 61128, 61129, 61259.
- b) Disconnect switches shall be three phase encapsulated, group operated, no break, with one common motor operated mechanism for all the three poles. They shall also have facilities for emergency manual operation and necessary handles shall be provided.
- c) Maintenance earthing switches shall be three phase encapsulated, group operated, no break, with one common motor operated mechanism for all the three poles. They shall also have facilities for emergency manual operation and necessary handles shall be provided.
- d) Disconnect switches and grounding switches shall have electrical and Mechanical interlocks to prevent grounding switch from closing on an energized section.

Interlocks with other bays for bus transfer switching shall be done through bay control cabinets. Actuation of the emergency manual operating device shall also disable the electrical control. Disconnectors in open condition shall be secured against reclosure.

Disconnecting switches and adjacent safety grounding switches shall have electrical interlocks to prevent closure of the grounding switches when the disconnecting switches are in the closed position and to prevent closure of the disconnecting switch when the grounding switch is in the closed position. The disconnector shall be pad lockable in the close & open position.

#### *Interlocks*

*Interlocking devices must provide absolute and positive protection against potentially harmful mal-operations of the switchgear. The following functions shall be assured:*

- i) Forcing the operator into the only safe and logic sequence to actuate breakers, switches, isolators and grounding switches.*
- ii) Checking the actual fully closed or fully open position of all switching elements before and after each move.*
- iii) Providing the logical checks and issuing the resulting PERMISSIVE or BLOCKED signals for the switchgear.*
- iv) Indicating positively the absolute condition/position of the supervised equipment.*
- v) Local manual and remote electrical operation of all essential functions.*
- vi) Local emergency unlocking facilities via safety-key switches under the full responsibility of the operator.*

*Intrabay and interbay interlocking shall be provided.*

*Electrical interlocking arrangement shall be fail-safe type.*

*Mechanical interlocks for isolator & Earthing Switch shall be fail-safe type.*

- e) All main contacts, male and female, shall be silver plated.
- f) Each disconnect switch and grounding switch shall open or close only due to motor driven or manual operation independently. The switch contact shall not move due to gravity or other means, even if a part fails. Once initiated, the motor mechanism shall complete an open or close operation without requiring the initiating contact be held closed.

***Operation of respective end position limit switches shall only disconnect the motor mechanism. There should also be a pre-set timer in motor circuit for protection against time over-run in case of inadvertent failure of drive mechanism in any intermediate position of the disconnect travel path.***

- g) The disconnect switches and grounding switches shall be located as shown in the Single Line Diagram.
- h) The disconnect switches shall be capable of interrupting the charging current of the connected GIS bus & associated components.

**i) Duty requirements:**

The disconnecting switches shall have breaking capabilities as per IEC requirements. Contact shielding shall be designed to prevent restrikes and high local stresses caused by the transient recovery voltages when currents are interrupted.

The bus disconnecting switches shall reliably handle capacitive currents due to the making and breaking of switchgear components as well as commutation currents due to bus bar reconfiguration.

The fast acting ground switches, used for overhead double circuit lines and underground cable feeders shall be capable of switching induced current as per IEC requirement.

*Short Circuit Requirements*

*The rated peak short-circuit current or the rated short time current carried by an isolator or earthing switch for the rated maximum duration of short circuit shall not cause:*

- a) Mechanical damage to any part of the isolator or earthing switch.*
- b) Separation of the contacts or contact welding.*
- c) A temperature rise likely to damage insulation.*

**j) Access for maintenance and repair:**

**Suitable means of access should be provided in each disconnect-switch and grounding-switch housing and mechanism for repair and/or maintenance of contacts.**



### **3.2.2 Operation Mechanism.**

3.2.2.1 Mechanism shall be arranged mechanically, electrically, so that all three phases of any particular disconnect switch or grounding switch operate simultaneously.

3.2.2.2 All mechanisms shall be suitable for electrical motor operation to achieve a fully automatic operation. For emergency situations manual operation shall be possible. Handles or hand cranks shall be provided, together with all necessary operation rods and rod guides. Manual operation shall be prevented if the interlocking system does not allow the operation of the switch.

3.2.2.3 The auxiliary supply shall be electrically decoupled from the motor when the switch is operated manually.

3.2.2.4 The mechanisms shall be arranged for locking in the open and in the closed position. Facility shall be available to allow the switch to be padlocked in any position.

3.2.2.5 Disconnecting operating mechanism of all disconnect/ isolator & earth switches shall be at easy operable height.

3.2.2.6 The isolator shall be provided with positive continuous control throughout the entire cycle of operation.

*The operating pipes and rods shall be sufficiently rigid to maintain positive control under most adverse conditions and when operated in tension or compression for isolator closing. They shall also be capable of withstanding all torsional and bending stresses due to operation of the isolator.*

*It shall not be possible, after final adjustment has been made, for any part of the mechanism to be displaced at any point in the travel sufficiently to a low improper functioning of the isolator when the isolator is opened or closed at any speed.*

*The operating mechanism design shall be such that during the operation of the isolator (especially manual operation), once the moving blades reach the sparking distance, springs shall take over to give a quick, snap action closing so that the isolator closing is independent of manual efforts. Similarly, the springs must assist during the opening operation to give quick breaking feature.*

*Disconnecter and high speed motor operated earthing switch mechanisms shall be provided with a mechanism with stored energy to always assure completed operations.*

### **3.2.3 Auxiliary Switches:**

*All disconnecting switches shall be provided with electrically independent auxiliary switch, directly driven by the common operating shaft. Each disconnect switch and grounding switch shall be furnished with sufficient Nos. of NO – NC as per entire scheme requirement plus two (2) NO-NC electrically independent contacts terminated up to terminal board, at user's disposal. The*

auxiliary switches shall indicate the position of the switch contacts, and shall be independent of the motor operation.

### 3.2.4 Position Indicators

3.2.4.1 Mechanically connected position indicators shall be provided externally to permit observation of close/open position of the disconnect switch and grounding switch. The place of Position Indicators should be easily visible from the place of operation of respective equipment.

3.2.4.2 Visual verification shall be provided for each pole of each disconnect switch and grounding switch to permit visual inspection of each switchblade position.

### 3.2.5 Technical Data Requirement: Disconnectors:

(To be customized by utility as per requirements & capacity)

Sr No.	Particulars	Parameters
1)	Enclosure	Three Phase
2)	Enclosure material	Aluminum Alloy
3)	Rated voltage	72.5 kV
4)	Rated current	1600 A
5)	Rated short-time current	25 kA rms, 3 sec
6)	Rated control and operating voltage	110/220 V DC
7)	Type of operating mechanism	Motor operated
8)	Type	Mechanically ganged operated
9)	Rated insulation level	
a)	Power frequency withstand voltage	
	- phase to phase, between phases	140 kV rms
	- Across the isolating distance	160 kV rms
b)	Lightning impulse withstand voltage	
	- phase to phase, between phases	350 kV peak
	- Across the isolating distance	375 kV peak
10)	Mechanical Endurance Class	M1
11)	Bus transfer switching capability (% of rated current)	80
12)	Rated bus charging current	0.1 A

### 3.2.6 Low-voltage test provision:

A low-voltage test provision may be supplied with a grounding switch to permit test voltages of up to 10kV (optional 2.5kV) and upto 200 A to be applied to the conductor without removing SF6 gas or other components, except for ground shunt leads.

### **3.3 Fast Acting Grounding Switches**

#### **3.3.1 General.**

3.3.1.1 Fast acting grounding switches can be located at the terminal of HV/EHV overhead line/ cable. They shall be able to switch safely load currents of overhead lines. They must have fault making capability and be able to switch on a live line. Applicable standards are IEC 60129, 60517, 61129. The fast acting grounding switches shall comply with the following general requirements of fast acting grounding switches and the latest revision of the relevant IEC specifications.

3.3.1.2 Fast acting grounding switches shall be of three phase, encapsulated, three phase linkage group operated by a maintenance-free self contained electrical motor. They shall also have facilities for emergency manual operation and the necessary operating handles or hand cranks shall be supplied.

3.3.1.3 Fast acting grounding switches shall be electrically or mechanically interlocked with related disconnector, to prevent the fast acting grounding switch from closing on an energized bus section.

3.3.1.4 All main contacts, male and female, shall either be silver plated or shall have silver inserts.

3.3.1.5 Each fast acting grounding switch shall open or close only due to motor-drive or manual operation but shall be operable from local only. The switch contact shall not move due to gravity or other means, even if a part fails. Once initiated, the motor mechanism shall complete an open or close operation without requiring the initiating contact to be held closed.

3.3.1.6 Each fast acting grounding switch shall be fully insulated and connected to ground by a removable bolted link in order that the grounding switch may be used for various test purposes. The insulation shall be capable of withstanding an applied power frequency voltage of 5 kV.

#### **3.3.2 Operation Mechanism.**

3.3.2.1 Mechanisms shall be coupled either mechanically or electrically or by both, so that all three phases of any particular fast acting grounding switch operate simultaneously *without any discrimination*.

3.3.2.2 All mechanisms shall be equipped with a motor suitable for operation from the auxiliary supply, and a set of springs so arranged that energizing of the motor will cause the springs to be charged and then released. The springs in turn shall close the fast acting grounding switch.

3.3.2.3 Motors shall be suitable for operation at any voltage between 80% and 110% of the rated auxiliary voltage, measure at the motor terminals.

3.3.2.4 For emergency situations manual operation shall be possible. Handles or hand cranks shall be provided, together with all necessary operation rods and rod guides.

3.3.2.5 The auxiliary energy shall be electrically uncoupled from the motor when the switch is operated manually.

3.3.2.6 The mechanisms shall be arranged for locking in the open and in the closed position.

### 3.3.3 Auxiliary Switches

Each fast acting grounding switch shall be furnished with sufficient Nos. of **NO – NC as per entire scheme requirement** plus two (2) NO-NC electrically independent contacts, suitably terminated at terminal blocks, at user's disposal. The auxiliary switches shall indicate the position of the switch contacts, and shall be independent of the motor operation.

### 3.3.4 Position Indicators

Mechanically connected position indicators shall be provided externally to ascertain the open/close position of the grounding switch. It should be easily visible from the place of operation of equipment.

**Visual verification shall be provided for each pole of each disconnect switch and grounding switch to permit visual inspection of each switchblade position.**

### 3.3.5 Test Facility

Each fast acting grounding switch shall be fully insulated and connected to ground by a removable bolted link in order that the grounding switch may be used for various test purposes. The insulation shall be capable of withstanding an applied power frequency voltage of 5 kV.

*High speed earthing switches shall be capable of interrupting line coupling currents upon opening and in worst conditions closing.*

### 3.3.6 Technical Data Requirement: High Speed Earthing Switch:

(To be customized by utility as per requirements & capacity)

S.No.	Particulars	66 kV
1)	Enclosure	Three phase
2)	Enclosure material	Aluminum Alloy
3)	Rated voltage	72.5 kV
4)	Rated short-time current	25 kA rms, 3 sec
5)	Rated peak withstand current	62.5 kA peak
6)	Type of operating mechanism	Motor operated
7)	Rated control and operating voltage	110 / 220 V DC
8)	Power frequency withstand voltage	140 kV rms
	across the open gap	160 kV rms
9)	Lightning impulse withstand voltage	350 kVp

	across the open gap	375 kVp
10)	Electrical Endurance class	E1
11)	Rated induced current switching capability	As per IEC 62271 – 102 class B

### Maintenance Earthing Switch: 66 kV

1)	Enclosure	Three phase
2)	Enclosure material	Aluminum Alloy
3)	Rated voltage	72.5 kV
4)	Rated short-time current	25 kA rms, 3 sec
5)	Type of operating mechanism	Motor operated
6)	Electrical Endurance class	E0
7)	Power frequency withstand voltage	140 kV rms
	across the open gap	160 kV rms
8)	Lightning impulse withstand voltage	350 kVp
	across the open gap	375 kVp

## 3.4 Current Transformers:

### 3.4.1 General

3.4.1.1 The current transformers provided for each phase shall be supplied in accordance with the following general requirements and the latest revisions of the relevant IEC 60044 specifications.

3.4.1.2 The current transformers must be suitable for continuous operation when installed on the conditions.

3.4.1.3 The current transformer shall be ring / toroidal type, multi ratio with fully distributed secondary windings with relay accuracy as per IEC 60185 (1987), incl. IEC 60044-4 (1992), multi core as per requirement and shall be mounted inside the high voltage enclosure.

3.4.1.4 The secondary terminals of current transformers shall be placed outside the high voltage enclosures, mounted in suitable, accessible terminal boxes and the secondary leads of all the current transformers shall be wired to shorting type terminals.

3.4.1.5 It shall be possible to test each current transformer without the removal of gas through the insulated grounding switches.

3.4.1.6 The number and position of the current transformers shall be relative to the circuit-breakers, disconnecting switches and ground switches as detailed in the single line diagram.

3.4.1.7 The rating, No of cores, ratios, accuracy class, characteristics etc. for the individual current transformer secondary cores shall be as specified. The various ratios of current transformers shall be obtained by changing the effective number of turns on the secondary winding.

3.4.1.8 Each current transformer shall be provided such that the enclosure current does not affect the accuracy or the ratio of the device or the conductor current being measured. Provision shall be made to prevent arcing across the enclosure insulation.

### 3.4.2 Rating and Diagram Plates

Rating and diagram plates shall be provided. The information to be supplied on each plate shall be as specified in the relevant IEC specification, which shall be given for the tap for which the rated performance is specified and for each transformer core.

**3.4.3 Technical Data Requirements** (To be customized by utility as per requirements & capacity)

<b>66KV class CT - Bay wise core requirement considering 20 MVA Transformer</b>								
Core No	Purpose	Ratio	Output burden	Accuracy class	Instrument security factor	Min. Knee point voltage at highest rated current	Max. excitation current at KPV	Max. CT Rct Sec. at highest ratio
<b>Fee</b>								
1	Metering	600-300 /	15	0.5	≤5	-	--	--
2	Dir. O/C-E/F Protection	600-300 / 1	10V A	5P	10	-	--	--
3	Dir. O/C-E/F Protection	600-300 / 1	10V A	5P	10	-	--	--
<b>Transformer bay (HV)</b>								
1	Metering	200-	15	0.5	≤5	-	--	--

2	Non - Dir. O/C-E/F Protection	200- 100 / 1	10VA	5P	10	-	-	--	--
3	Differenti al Protection	200- 100 / 1	--	PS	--	600 V	25 mA	< 5 Ohm	
4	Differenti al Protection	200- 100 / 1	--	PS	--	600 V	25 mA	< 5 Ohm	
<b>Bus coupler bay</b>									
1	Metering	600- 300 /	15	0.5	≤5	-	-	--	--
2	Non - Dir. O/C-E/F Protection	600- 300 / 1	10VA	5P	10	-	-	--	--
3	Non - Dir. O/C-E/F Protection	600- 300 / 1	10VA	5P	10	-	-	--	--

### 3.5.1 VOLTAGE TRANSFORMER:

#### 3.5.1.1 SF6 insulated:

Each voltage transformer shall be *metal enclosed*, SF6 insulated in accordance with relevant IEC 60044. The location, polarity, ratios, and accuracy shall be as specified.

#### 3.5.1.2 Construction:

*VTs should be in segregated compartment and not forming a part of bus bar.* Transformers should be of either plug-in construction or the disconnect-link type, and be attached to the gas-insulated system in such a manner that they can be easily disconnected while the system is being dielectrically tested.

Alternately, a voltage transformer designed so that it does not have to be disconnected during dielectric testing may be specified. The metal housing of the transformer should be connected to the metal enclosure of the GIS with a flanged, bolted, and gasketed joint so that the transformer housing is grounded to the GIS enclosure. *Adequate measures shall be provided to prevent any*

*unacceptable impact on the secondary control and protection circuits, which might result from fast transients (VFT) or Ferro-resonance.*

### **3.5.1.3 Covers and shields:**

Special covers and any necessary corona shields should be supplied so that the system can be pressurized and dielectrically tested after removal of the transformer.

### **3.5.1.4 Primary and secondary terminals:**

Primary and secondary terminals should have permanent markings for identification of polarity, in accordance with IEC.

*3.5.1.5 Provision shall be made for grounding of the secondary windings inside the local control cabinet.*

*3.5.1.6 Test condition for tests at site: Power frequency tests for the completed GIS at site shall be possible without removing the VT. The primary and secondary neutral terminal points, intended to be earthed, should be insulated and shall withstand power frequency voltage of 3 kV rms for 1 minute. The VT shall be capable to withstand discharge current arising from capacitance of underground cable circuits.*

### **3.5.1.7 Technical Data Requirement:**

S. No.	Particulars	Parameters
1)	Rated voltage	66 kV
2)	Highest system voltage	72.5 kV
3)	Rated frequency	50 Hz
4)	P F (dry) withstand voltages	140 kV
5)	Voltage factor	1.2 continuous
6)	1.2/50 micro sec. lightning impulse withstand voltage	350 kVp
7)	Earthing	Effective

### **66 KV class PT Core Details**

Core	Purpose	Ratio	Burden	Class of accuracy
1	Metering	$\frac{66KV/\sqrt{3}}{110V/\sqrt{3}}$	50 VA	0.5



2	Protection	$\frac{66KV}{\sqrt{3}}$ $\frac{110V}{\sqrt{3}}$	50 VA	3P
3	Protection	$\frac{66KV}{\sqrt{3}}$ $\frac{110V}{\sqrt{3}}$	50 VA	3P

### 3.5.2 BUSHINGS:

Outdoor bushings shall be provided for connection of conventional external conductors to SF6 GIS if asked in general layout plan.

Suitable clamp & connectors shall be supplied with bushing. The dimensional and clearance requirements for the metal clad enclosure shall be maintained as per requirement of relevant standards.

All the bushings shall have an impulse & power frequency withstand level that is higher or equal to the level specified in cl. 2.3.

Only SF6 insulated composite silicon bushings will be accepted. The terminals on the outdoor bushings shall be a solid stem with dimensions specified.

### 3.5.3 Metal-Enclosed Surge Arresters:

The 60 kV, hermetically sealed, Gapless, ZnO, Surge arrester, suitable for use with GIS, for each phase, at the 66 kV line underground cable entry terminals of GIS shall be provided, if indicated in Schedule of requirements. Each Surge Arrester shall be provided with self leakage current monitoring device at convenient elevation.

They shall have adequate thermal discharge capacity for severe switching surges, long duration surges and multiple strokes. The surge arresters when provided with pressure relief devices shall be capable of withstanding the internal pressures developed during the above discharges without operation of the pressure relief devices.

Surge Arresters, if any provided, shall be of either the "plug-in" construction or the disconnect-link type and be attached to the gas-insulated system in such a manner that they can be readily disconnected from the system while the system is being dielectrically tested. The metal housing of the arrester shall be connected to the metal enclosure of the GIS with a flanged, bolted joint.

The ground connection shall be sized for the fault level of the GIS. It shall be insulated from the GIS-enclosure and grounded externally to permit periodic maintenance and monitoring of the leakage current.

If the arresters are not equipped with removable links, special covers and any necessary corona shields should be supplied so that the system can be pressurized and dielectrically tested after removal of the arrester.

Access to the arrester ground connection, when it is provided with means for leakage current monitoring should not be obstructed.

### 3.6 Insulating Gas and gas leakage rate

The GIS shall be furnished with sufficient sulfur hexa fluoride (SF6) gas to pressurize the complete system in a sequential approach, one zone or compartment at a time to the rated nominal density. The guaranteed leakage rate of each individual gas compartment and between compartments must be less than 0.5% p.a. for the service life of equipment.

The quality of new filled-in SF6 gas shall meet the following requirements in line with IEC 60376.

*SF6 > 99.90 % by weight*

*Air < 500 ppm by weight (0.25 vol.-%)*

*CF4 < 500 ppm by weight (0.1 vol.-%)*

*H2O < 15 ppm by weight (0.012 Vol.-%)*

*Mineral oil < 10 ppm by weight*

*Acidity, in terms of HF < 0.3 ppm by weight*

*Hydrolysable fluorides,*

*In terms of HF < 1 ppm by weight*

### 3.7 Reuse or recycling of removed gas:

The supplier should provide guidelines or recommended practices for the reuse or recycling of SF6 gas removed from the equipment. These guidelines should be consistent with current industry practices, as they pertain to the effect of SF6 on global warming; i.e. SF6 gas should be reused and recycled whenever possible and never be unnecessarily released into the atmosphere. *Clear instructions shall be provided by bidder about handling, recycling & treatment of new and used SF6 gas.*

*During commissioning dew point of SF6 gas shall be measured and documented.*

*Components may be filled with N2 for transportation and refilled with SF6 at site.*

### 3.8 Gas sections

The GIS enclosures (one enclosure for all the three phases) shall be divided into several gas sections separated by gas-tight barriers. Each section shall be provided with necessary valves to allow evacuation and refill of gas without evacuation of any other section. **Location of gas barrier insulators is to be clearly discriminated outside the enclosure by a band of distinct colour normally used for safety purposes.**

The gas system proposed shall be shown on a "gas single line diagram" and submitted with the technical bid. **It should include the necessary valves, connections, density monitors, gas monitor system and controls, indication,**

**orifices, and isolation to prevent current circulation. Means of calibrating density monitors without de-energizing the equipment should be specified by the supplier.**

For the purpose of gas monitoring and maintenance, the GIS shall be divided into various individual zones in each bay. **The CB gas zone shall be independent from all other gas compartments and shall meet the requirement of relevant IEC.**

Each gas zone shall be furnished with a gas monitoring system consisting of a gas density continuous monitoring device provided with two electrically independent contacts which operate in two stages as follows:

a) First alarm : At a gas density normally 5 to 10% below the nominal fill density.

b) Second alarm: Minimum gas density to achieve equipment ratings.

**In special cases determined by the supplier, a third stage with a set of contacts may be necessary in certain areas.**

Provisions shall be made for connecting pressure gauges, service cart, and moisture test instrumentation to any one of the gas sections.

*Permanent Gas Treatment Devices:*

*Means shall be provided inside each enclosure for treating the SF<sub>6</sub> gas by the use of Desiccants, driers, filter, etc. to remove impurities in the gas. All gas compartments shall be fitted with static filter material containers that will absorb residual and entering moisture inside the high voltage enclosures. Filters inside the breaker compartment shall also be capable of absorbing gas decomposition products resulting from the switching arc.*

### **3.9 GIS Connection:**

#### **3.9.1 GIS to TRANSFORMER:**

Transformers shall be connected to the GIS by termination of 66 kV XLPE power cable. The connection between GIS and high voltage cable at GIS end shall be done through cable termination / cable sealing end. For transformer end connection the cable termination on structure shall be provided outdoor, if specified in schedule of requirements. The plug in cable sealing ends for XLPE cables shall consist of gas tight plug in sockets and prefabricated plugs with grading elements of silicone rubber.

#### **3.9.2 GIS to LINE:**

The 66 kV line will be terminated to GIS by XLPE power cable

#### **3.9.3 66 kV Power Cable connection:**

The connection between GIS and high voltage cable at GIS end is done through cable termination / cable sealing end. Plug in cable sealing ends for XLPE cables shall consist of gas tight plug in sockets, and prefabricated plugs with grading elements of silicone rubber.

A separate cable basement is provided for cable entry, its distribution and installation.

**The design of the cable end box shall fully comply with the IEC standard. The type and size of cable is specified. All end cable modules shall be suitable for connecting single core, XLPE specified cable.**

Necessary provision for termination of specified nos. of such power cables shall be made in GIS. GIS supplier shall either carry out the work of termination or coordinate with cable terminator for such connection as specified in schedule of requirement. Provision shall be suitable for terminating cable size and type approved by utility.

### **3.10 Local & Remote Control and Operation**

#### **3.10.1 General**

One local control cabinet (LCC) for GIS shall be supplied for the local control and operation of each bay. Each LCC shall contain the local control, interlocking, operation and indication devices for the associated GIS bay.

The LCC shall be mounted on each GIS bay. The LCC's shall be located with sufficient space for access and the possibility to work at the equipment even when the LCC doors are open, or directly at the switch-gear in front of the related circuit breaker.

The LCC's shall be installed indoor and care must be taken with the design to ensure that all LCC's are drip and splash proof. The LCC's shall also be dust and vermin proof. The control and operation circuits shall be well shielded and with safety measures to protect operator from touching energized parts. Power frequency withstand of control circuits shall be 2 kV for 1 minute.

The LCC should have required arrangement for control and operations of GIS from Remote i.e. from the control room through SCADA compatible control and protection panel.

The LCC shall include all required functions for control and supervision of a complete GIS as well as the marshalling of all connections to and from the GIS bays.

Safe station operation is ensured through following base functions.

- i) Feeder & station interlocking, depending on the position of all high voltage components with their blocking functionality.
- ii) Blocking of commands when crank handle of disconnect or earthing switches is introduced.
- iii) Extensive circuit breaker supervision through "Anti-Pumping", pole discrepancy, Gas density and position supervision of circuit breaker,

#### **3.10.2 Required features for conventional local control cabinets**

The LCC's shall be provided with the following features:

a) A mimic diagram showing the single line diagram. Position indicators, on/off switches for the HV devices and local / off / remote switches shall be installed on or adjacent to the various symbols of the mimic diagram.

The following devices shall be supplied as a minimum:

- Circuit breaker control switches with ON – OFF indicating lamps. – Circuit breaker “local-remote” selector switch.
  - Disconnect switch, control switch with ON – OFF indicating lamps.
  - Grounding switch, control switch with ON – OFF indicating lamps.
  - Mimic bus including symbols according to the single line diagram.
  - Monitoring control of all high voltage switching devices in a bay.
  - Digital display of current, voltage, active and reactive power, power factor etc.
- b) Any interposing relays and control switches associated with the circuit breakers disconnect switches, grounding switches etc.
- c) The alarm and indication for devices specified e.g. gas, DC & AC supervision.
- d) Fuses and links. These shall be installed in the interior of the LCC's
- e) Terminal blocks for the terminating and marshalling of auxiliary supply circuits, control, interlocking, and indication & alarm circuits from the GIS and for cable connections to the remote control room or the owner's control system.
- f) Each LCC shall be furnished with a guarded resistance heater to prevent the internal equipment from humidity deposit. The heater shall be rated 230 V AC and fed through a two pole fused disconnect switch.
- g) A fluorescent lamp and a duplex convenience outlet rated 230 V AC, 15 amps with ground fault interrupter shall be installed in each LCC.
- h) The Local control cubicle shall be fitted with pre wired interface terminal blocks for connection to user's control & protection panels. The interface includes CT & PT inputs for protection & measuring system, Protection trip 1 & 2 signals, Aux switch contacts etc.

### 3.10.3 Wiring Requirements

- i) Each circuit breaker shall have control suitable for operation on 110 V DC with two electrically independent trip circuits. The miniature circuit-breakers (MCB) shall be provided for the closing circuit and an independent separate switch fuse unit of suitable rating shall be provided for the primary and back up trip circuits.
- ii) Wiring shall be complete in all respects to ensure proper functioning of the control, protection, and monitoring and interlocking schemes.
- iii) DC circuit for trip coil 1 & 2 shall be wired separately.
- iv) Wiring shall be done with flexible 1100V grade, FRLS, PVC insulated, switchboard wires with 2.5 mm<sup>2</sup> stranded copper conductor. *The control wire in a grouped environment shall not convey flame, continue to burn.* Wiring between equipment and control cubicle shall be routed through G.I. rigid

conduits and shall be done by PVC & screened cable only, *with safety measures to protect operator from touching energized parts.*

v) Each wire shall identify at both ends with permanent markers bearing wire numbers as per Contractor's wiring diagram.

vi) Wire termination shall be done with crimping type connectors with insulating sleeves. Wires shall not be spliced between terminals.

vii) All spare contacts of relays, push buttons, auxiliary switches etc. shall be wired up to terminal blocks in the control cubicle.

viii) Terminal blocks shall be 1100V grade, stud type with engraved numbers suitable for termination of at least two numbers of 2.5 mm<sup>2</sup> stranded copper conductor. Terminal blocks for CT, PT, auxiliary AC & DC supply shall be disconnecting link type.

ix) Not more than two wires shall be connected to any terminal. Spare terminals equal in number to 20% active terminals shall be furnished.

x) Terminal blocks shall be located to allow easy access. Wiring shall be so arranged that individual wires of an external cable can be connected to consecutive terminals.

xi) Terminal connectors that carry power supply should be shrouded from adjoining connectors.

xii) Manufacturer shall provide all control wiring and terminations internal to the switchgear, and connecting the switchgear to the bay control cabinets.

xiii) All control cables shall be shielded. Cable shields shall be grounded. Grounding connections shall be as short and direct as possible and shall terminate at the point of entry to cabinets or terminal boxes.

xiv) Co-axial type cable glands suitable for use with shielded cables shall be used at each termination.

xv) All control cables shall be installed and terminated in such a manner as to limit the effects of transient electromagnetic voltages on the control conductors to an acceptable level.

xvi) Any cabling within GIS shall be supported on cable tray. No cable shall be in hanging position.

xvii) Insulator cones shall be embedded in full return current carrying metal fixing rings in order to avoid mechanical stresses to the cast resin part and to impart full conductivity across the flange connection. Earthing of different gas compartments/enclosures is not allowed with cross bonding with any metal strips.

#### **3.10.4 Connections within the GIS and their LCC's**

All cable connections between the various GIS modules and the LCC's shall be made by prefabricated multi-core cables *with multipoint plug in connections on both the ends. PTs & CTs circuit shall be wired with crimped type copper lugs.*

All cables shall be shielded and adequate for their application (indoor / outdoor). The cables shall be fire retardant low smoke.

The length and the number of terminal points of control wiring & SF6 gas connections shall be minimized.

The electrical connections between the various gas sections shall preferably be made by means of multiple contact connectors so that electrical connection is automatically achieved when bolting on section to another. The surface of the connector fingers and conductor tubes on such connections shall be silver plated.

### **3.11 Name plates**

Name plates of the following types shall be furnished in a convenient central location to provide information for operation and maintenance.

- a) Gas Single Line Diagram showing all HV devices in a single line diagram with the gas sectionalizing of the GIS indicated. Also shown shall be the GIS nomenclature, a legend, Manufacturer's type and serial number and year of manufacture.
- b) GIS Rating / Name plate:

Manufacturer's name & address, type & designation, Sr. No, Maximum ambient temperature, System frequency, Maximum continuous voltage, Maximum continuous current at 40°C ambient temperature, Basic Impulse Level, Power Frequency one minute voltage, Short circuit current, rms., symmetrical Short time (rms) current & duration, symmetrical Momentary current, peak, Total weight of gas at rated density, Rated gas pressure at 20°C. Opening pressure of the bursting disc, recommended moisture limits of insulation gas (PPMV), Auxiliary voltages, Contract/Purchase Order numbers, Total weight of the equipment

- c) Equipment nameplate containing nameplate rating information for all HV modules (like circuit breaker, disconnect switches, current transformer, voltage transformer, surge arrester, etc.) as required in relevant IEC.
- d) Nameplates showing serial numbers and similar data specific to individual components shall be mounted on the components. *Each instrument transformer must have its own rating plate mounted adjacent to each terminal box cover, will all terminal and ratio markings. Each bay auxiliary control cubicle must be identified with its designation to which it is assigned.*

**3.11.1** Bidder shall specify the number of skilled / semi-skilled / unskilled persons, supervisors and Engineers required to be deputed for complete erection, testing, commissioning of GIS board.

### **3.12 Type Tests:**

Following type test reports from NABL laboratory, as specified in IEC standard 62271 – 203 & 62271-100 (amended up to date) shall be submitted for the offered type, rating of GIS invariably with the technical bid. Bid without type

test reports will not be considered for evaluation. The type test reports shall not be older than FIVE years and shall be valid up to expiry of validity of offer.

1. Tests to verify the insulation level (Lightning impulse, Switching impulse and ac withstand test with PD) test on each GIS device (CB, Disconnecter, bus, etc).
2. Dielectric tests on auxiliary circuits.
3. Tests to prove the radio interference voltage (RIV) level.
4. Tests to prove the temperature rise of any part of the equipment and measurement of the resistance of the main circuit.
5. Tests to prove the ability of the main and earthing circuits to carry the rated peak and the rated short time withstand current.
6. Tests to verify the making and breaking capacity of the included switching devices.
7. Tests to prove the satisfactory operation of the included switching devices.
8. Tests to prove the strength of enclosures.
9. Verification of the degree of protection of the enclosure.
10. Gas tightness tests
11. Electromagnetic compatibility tests (EMC).
12. Additional tests on auxiliary and control circuits.
13. Tests on partitions.
14. Tests to prove the satisfactory operation at limit temperatures.
15. Tests to prove performance under thermal cycling and gas tightness tests on insulators.
16. Corrosion test on earthing connections (if applicable).
17. Tests to assess the effects of arcing due to an internal fault.
18. Tests on solid dielectric components (operating rods, spacers, etc)
19. Seismic test
20. Test on Auxiliary switches (Electrical & Mechanical Endurance, Heat run, IR & HV test)

***Important note for type tests:*** *The type test report shall be submitted for the offered class and rating of GIS. However, the type test report for higher class/rating can be accepted for scrutiny of technical bid but the same test/s shall have to be carried out on the offered class/rating GIS. Bidder shall invariably confirm to carry out the required type test/s, special tests, before commencement of supply, without affecting delivery schedule, free of cost, at NABL approved laboratory, or at suppliers works in presence of Utility representative, in the event of order.*

### **3.13 Routine / Acceptance Testing:**

During manufacture and on completion, all equipment shall be subjected to the Routine tests as laid down in IEC Standard IEC 62271-203. All the acceptance



tests shall be carried out in presence of Utility representative on offering the material for inspection and testing by successful bidder. Tests shall include the following:

1. Dielectric test on the main circuit.
2. PD test
3. Tests on auxiliary and control circuits.
4. Measurement of the resistance of the main circuit.
5. Tightness test.
6. Design and visual checks.
7. Pressure tests of enclosures.
8. Functional tests
9. Tests on auxiliary circuits, equipment and interlocks in the control mechanism.
10. Pressure test on partitions.

#### **3.14 Test Certificates:**

- a. Certified reports of all the tests carried out at the works shall be furnished in required number copies for approval of the Owner.
- b. The equipment shall be dispatched from works only after receipt of Owner/Purchaser's written dispatch clearance & approval of the test reports.
- c. Routine test certificates of bought out components shall be furnished.
- d. Type test certificate on any equipment or component if so desired by the Owner shall be furnished. Otherwise the equipment shall have to be type tested, free of charge, to prove the design.

#### **3.15 Tests after installation of complete GIS at Site:**

After installation and before being put into service, the GIS shall be tested in order to check the correct operation and dielectric integrity of the equipment as laid down in IEC 62271-203. The successful bidder shall furnish a commissioning test plan and a statement method for the tests on site. Tests shall include the following:

1. Dielectric tests on the main circuits.
2. Dielectric tests on auxiliary circuits.
3. Measurement of the resistance of the main circuit.
4. Gas tightness tests.
5. Checks and verifications.
6. Gas quality verifications.
7. On site power frequency voltage withstand test with PD test.
8. Tests as per IEEE C37.122.1 clause 4.10.5
9. Functional & interlock tests for all items

10. Demonstration of operational compatibility with SCADA, if installed
11. Visual inspection, checks & verifications.
12. Mechanical operation tests of circuit breakers, Disconnectors and earthing switches and high-speed earthing switches
13. Insulation resistance measurement
14. Tests on CTs and PTs
15. Tests on Surge Arresters

### **3.15.1 Required test equipment**

During the onsite tests, the supplier shall provide all necessary test facilities and equipment for the switch-gear power frequency tests, i.e. test bushing or test cable, test adapter, test transformer or resonant test set etc.

### **3.16 Spares:**

Bidder shall submit a list and supply of following spares.

- i) Recommended spare parts for three (3) years after guarantee period of satisfactory and trouble-free operation.
- ii) Commissioning spares
- iii) Maintenance spares
- iv) Special tools, tackles & spanner required during commissioning, operation and maintenance.
- v) Viewing mechanism
- vi) Spare GIS modules of CT, Breaker and Isolator & LA. All spares indicated in list for above shall be considered in the scope of supply.

Each list shall be complete with specification, ratings, type, make, identification number, unit rate, quantity etc.

### **3.17 DRAWINGS, DATA & MANUALS:**

Drawings, Data and Manuals shall be submitted in triplicate with the bid and in quantities and procedures as specified in General Conditions on Contract and/or elsewhere in this specification for approval and subsequent distribution after the issue of Letter of Intent.

#### **To be submitted with the Bid:**

1. Typical general arrangement drawings of the equipments indicating space requirement, room dimensions, crane capacity etc.
2. Technical Specifications of equipment and special tools explaining construction features, principle of operation, special features etc.
3. Comprehensive QAP, FQP, SLD, Gas Schematic diagram, Technical brochures, building requirements, Earth mat design, List of recommended spares, special tools or fixtures, O&M manuals, environmental guide for handling SF6 gas & decommissioning, estimated time schedule for installation & commissioning, bill of materials, and any other documents required for successful commissioning & operation of complete GIS.

#### 4. Control and protection:

Block & principle diagram showing proposed scheme, layout & equipment arrangement drawings, catalogues & brochures of offered devices.

**Successful bidder shall submit 3 sets of spiral bound volume of following drawings & data for approval before commencement of supply:**

1. A comprehensive Manufacturing Quality assurance plan with effective quality assurance system.
2. Field Quality plan indicating instruction & procedures sequenced for storage, assemble, maintenance and disassembly.
3. Assemble and maintenance clearance requirements.
4. Dimensional general arrangement drawing showing disposition of various fittings, name plates indicating equipment ratings.
5. Structure Plan with details and loading
6. Foundation plan indicating loadings for all GIS equipment, supporting structure and anchor bolt arrangements.
7. Assembly drawing for erection at site with part numbers and schedule of materials Transport/shipping dimensions with weights.
8. Control schematic and wiring diagrams.
9. Gas schematic Diagram
10. Gas system installation procedures, gas handling procedures.
11. Grounding arrangement and ground bus details including Manufacturer's recommendation on Grounding of reinforcement bars of Column foundation.
12. Calculation of Voltage rise for GIS enclosure
13. Calculated point to point resistance for each assembly.
14. Calculation for Surge Protection
15. Design Calculations for Bus-bar sizing, Short circuit forces and vibration on Bus-bar & each equipment, thermal stability and losses.
16. Any other relevant drawing or data necessary for satisfactory installation, operation and maintenance.
17. Operating instruction & manuals for GIS and its accessories
18. The manual shall clearly indicate method of installation, checkups and tests to be carried out before commissioning of the equipment.
19. The bidder shall note that the approval of drawings & documents by the Owner does not relieve him of his contractual obligation.

The bidder may note that the drawings, data and manuals listed herein are minimum required only. The bidder shall ensure that all other necessary write-up etc. required to fully describe the equipment are to be submitted with the bid.

All drawings shall be prepared by using AutoCAD and documents shall be generated using Electronic version. The paper copy of the drawings & document shall be submitted for

approval & reference. All final drawings and documents shall be submitted in CD in AutoCAD and MS office format as applicable for Owner's future reference. Also AutoCAD version of Main GA drawings is to be submitted for Owner's layout finalization.

### **3.18 Maintenance:**

The operational integrity of the GIS switchgear shall not subject to external influences, such as pollution, moisture, dust etc. As a consequence of this GIS switchgear should be practically maintenance free, however, the details of inspection required at regular interval shall be indicated in the offer. Visual inspection shall be required not below 2 (two) years interval.

Inspection shall not be required often than every 10 years. During inspection it must not be necessary to open the switchgear enclosures for interrupt operation of substation. Provision of functional testing of the close and trip coils, auxiliary switches, pressure and control switches etc. shall be provided. Following minimum maintenance period shall be accepted.

- (a) Circuit breaker: 5000 closing and opening or 20 interruption at max rated current
- (b) Disconnecter: 5000 closing and opening operations.
- (c) Fast acting earth switch: 2000 closing and opening operations or 2 making operations on to max rated fault current.

*The bidder shall provide the services of experienced persons, supervisors, engineers, experts, etc., for complete specified work for satisfactory operation.*

*The bidder shall have dedicated localized after sales & service team which should be capable any activity to operate complete GIS satisfactorily.*

### **3.19 GIS Building**

The GIS building, if it is a part of schedule of requirements, shall comply with the requirements of Civil specifications.

The proposed arrangement of building and positions in which the switchgears shall be installed relative to lines, transformers, cable circuit and any other switchgear of any other voltages will be indicated in general arrangement layout. The overall height of building shall allow for overhead traveling crane.

### **3.20 Design information to be submitted by bidder.**

The bidder shall provide complete floor plan detailing the fixing positions, levels and size of fixing bolt pockets and foundation required for all equipments. Drawings giving similar details shall be provided.

All static and dynamic loads plus dimensional tolerances shall be given on these drawings.

3.21 Guaranteed and technical particulars as called for in attached **SCHEDULE 'A'** shall be furnished along with the technical bid.

### **3.22 Training:**

Training to ..... (...) persons of Utility on construction, installation, commissioning and O&M shall be imparted by bidder free of cost.

*Duration of the complete training shall be 7 working days, covering minimum below specified curriculum. Any other specific area may be brought to notice and included.*

1. General Explanation for GIS
2. Layout and Architecture of GIS
3. Gas Sectionalisation of GIS
4. Construction of CB
5. Operating Mechanism of CB
6. Maintenance of CB
7. Overhaul of CB (Interrupting chamber)
8. Overhaul of CB (Operating Unit)
9. Construction of DS/ES
10. Maintenance of DS/ES
11. Overhaul of DS/ ES
12. Construction of Bus/ Cable head/ SF6 – air bushing
13. Maintenance of Bus/ Cable head/ SF6 – air bushing
14. Overhaul of Bus/ Cable head
15. Overhaul of various transformer connections
16. Operation of GIS with SCADA (if SCADA installed)
17. Construction & Maintenance of Lightning Arrester
18. Construction & Maintenance of VT/CT
19. Construction & Maintenance of Local control panel
20. Erection of GIS at site.
21. Installation & Testing of GIS at site
22. Type tests of GIS
23. Routine tests of GIS.
24. Faults simulation of GIS
25. Localization of GIS fault.

Bidder shall at his cost arrange for the above training facilities. The purchaser shall bear all TA/DA expenses of all the trainees.

### ***3.23 Shipment storage and installation:***

All equipments shall be suitably packed and protected during shipment/transportation. Each shipping unit shall be sealed in a clean dry condition with leak-tight shipping covers securely mounted for shipment. All covers to be removed during installation shall be clearly marked. Each shipping section shall be carefully sealed and filled with dry gas to a slightly positive pressure to prevent the entrance of moisture and contamination.

The packing method for the GIS equipment shall be standard and it shall be guaranteed that each component of the equipment will not be damaged, deformed or lost. The storage instructions shall be submitted by bidder for long term storage. Component requiring

indoor storage shall be so identified. Gas insulated switchgear (GIS) shall be properly packed to protect during ocean shipment, inland transport, carriage at site and outdoor storage during transit and at the site. Completely assembled bays (subject to transport limitations) of the GIS shall be transported as one shipment unit.

Packing materials shall be dust and waterproof. All packages shall be clearly, legibly and durably marked with uniform block letters on at least three sides. Fragile items like bushings, CTs, VTs, LAs and fully assembled bays shall be securely packaged and shipped in containers. Silica gel or approved equivalent moisture absorbing material in small cotton bags shall be placed and tied at various points on the equipment wherever necessary.

As far as possible, transshipment should be avoided.

Impact recorders (Accelerometers) shall be provided on the packages to confirm that GIS has not suffered any shocks during shipment, transport, handling, etc. The impact recorder readings are to be noted on receipt of equipment at site and reported to user & manufacturer, in case the readings are exceeding the permissible values. It shall be at discretion of user to accept or reject the same.

### **3.24 Quality Assurance**

Superior quality control system shall be adopted to assure high product quality. Raw materials of the best commercial grade quality and high reliability shall be used in the manufacture of GIS. High reliability of materials shall be ensured so as to keep maintenance work to a minimum.

A quality assurance plan for major components such as breakers, disconnecting switches, lightning arrestors, earth switches, etc. with in-process inspection methods, tests, records, etc. shall be submitted with the technical bid. Customer hold points will also be included in the plan, which shall be mutually agreed by the PURCHASER and MANUFACTURER, and approved.

**BIDDING SCHEDULE (To be filled in and signed by the Bidder)****SCHEDULE 'A'****SCHEDULE OF GUARANTEED TECHNICAL PARTICULARS FOR GAS INSULATED SUBSTATION**

<b>Sr No</b>	<b>Particulars</b>	<b>To be Filled by BIDDER</b>
<b>1</b>	<b>General</b>	
<b>2</b>	Name of manufacturer (OEM)	
<b>3</b>	Country of Origin	
<b>4</b>	Delivery from (location)	
<b>5</b>	Type & Designation	
<b>6</b>	Type tested at	
	Name of Laboratory	
	Address of laboratory	
<b>7</b>	Installation (indoor or outdoor)	
<b>8</b>	Standards applicable	
<b>9</b>	No. of Phases	
<b>10</b>	Single or Three Phase design	
<b>11</b>	<b>Configuration</b>	
i	Number of Feeder bays	
ii	Number of transformer bays	
iii	Number of Bus coupler bay	
iv	GIS to transformer connection	
v	GIS to Feeder connection	
vi	Number of VT	
vii	Number of SA	
	Future extension possibility	
<b>12</b>	<b>Service conditions</b>	
i	Ambient Air Temp. in Deg. C	
ii	Max Temp. in Deg. C	
iii	Min Temp. in Deg. C	
iv	Daily Average Temp. in Deg. C	
v	Solar Radiation W/sq mtr	
vi	Altitude above MSL, in mtr	
vii	Pollution class	
viii	Creepage distance, in mm/kV	
ix	Relative humidity	
x	Condensation	
xi	Vibration level	
xii	Noise level	

xiii	Induced Electromagnetic Disturbance, in kV	
xiv	Seismic conditions	
a	Vertical	
b	Horizontal	
<b>13</b>	<b>Enclosure</b>	
i	Code of pressure vessel	
ii	Type of manufacturing	
iii	Design temperature in Deg.C	
iv	Material	
v	Material grade & applicable standard	
vi	Outside diameter in mm	
vii	Minimum Wall Thickness, in mm	
viii	Painting Shade & Thickness	
a	- External	
b	- Internal	
ix	Degree of Protection	
x	Inductance in H/mt	
xi	Capacitance in pF/mt	
xii	Resistance in Ohm/mt	
xiii	Expansion Bellow	
a	Material	
b	Min allowable adjustable displacement	
	Longitudinal	
	Transverse	
xiv	Sealing system	
a	Type	
xv	Estimated life in years	
xvi	Barrier	
a	Material	
b	Dielectric strength	
<b>14</b>	<b>Support Structure</b>	
i	Material	
ii	Minimum thickness of galvanizing	
iii	Foundation channels /Anchor bolts	
<b>15</b>	<b>Grounding</b>	
i	Grounding Material	
ii	Grounding of complete GIS	
iii	Grounding of individual compartment	



iv	Grounding at flange joints	
<b>16</b>	<b>System Parameters</b>	
i	Highest System voltage in kV	
ii	Rated voltage of System in kV	
iii	Rated voltage of Equipment in kV	
iv	Rated Insulation level Phase to Earth and between Phases	
a	One Min Power Frequency withstand voltage kVrms	
b	Switching impulse withstand voltage, kVp	
	- Phase to Earth	
	- Between Phases	
c	Lightning Impulse withstand voltage, kVp	
iv	Rated Frequency	
v	Rated current in Amp	
vi	Rated current at 50 °C (equipment) in Amp	
vii	Rated current at 50 °C (bus bar) in Amp	
viii	Rated short circuit withstand current kArms	
a	Duration in sec	
b	Peak, kAp	
ix	Enclosure withstand time for an internal fault in sec.	
x	Estimated total energy loss at	
	100 % of rated capacity	
	75 % of rated capacity	
	50 % of rated capacity	
	25 % of rated capacity	
xi	Measures taken to minimize Over Voltage	
xii	Phase labeling	
xiii	<b>Auxiliary supply (AC Voltage, Frequency; DC voltage)</b>	
	- Operation	
	- Control	
	- Illumination & heater	
<b>17</b>	<b>Delivery conditions</b>	
i	Bays fully assembled at works	

ii	Dimensions of longest section for transportation	
iii	Weight of heaviest package	
iv	Pressure of SF6 gas during transportation	
v	SF6 gas monitoring system provided during transportation	
<b>18</b>	<b>Bus Bar</b>	
i	Configuration (Single / Double)	
ii	Nos of Phases	
iii	Material	
iv	Size	
v	Rating	
vi	Current density adopted	
vii	Current density as per type test report	
viii	Short time current withstand rating in kA	
ix	Duration	
x	Resistance per phase	
xi	Surge impedance	
xii	SF6 immersed insulator	
a	Material	
b	Dielectric strength	
xiv	Maximum Partial Discharges measured at HSV	
<b>19</b>	<b>SF6 Gas</b>	
i	Applicable standard	
ii	Quantity of SF6 Gas of complete GIS at filling pressure, in kg	
iii	Quantity of SF6 Gas of largest compartment GIS at filling pressure, in kg	
iv	Nos of Gas compartments	
v	Quantity of SF6 Gas of individual compartment GIS at filling pressure, in kg	
vi	Maximum permissible dew point, in Deg.C	
vii	<i>Composition of Gas</i>	
a	<i>SF6 &gt; 99.90 % by weight</i>	
b	<i>Air &lt; 500 ppm by weight (0.25 vol.-%)</i>	

<i>c</i>	<i>CF4 &lt; 500 ppm by weight (0.1 vol.-%)</i>	
<i>d</i>	<i>H2O &lt; 15 ppm by weight (0.012 Vol-%)</i>	
<i>e</i>	<i>Mineral oil &lt; 10 ppm by weight</i>	
<i>f</i>	<i>Acidity, in terms of HF &lt; 0.3 ppm by weight</i>	
<i>g</i>	<i>Hydrolysable fluorides, In terms of HF &lt; 1 ppm by weight</i>	
	<b>PRESSURE</b>	in MPa in kG/sqcm
vii	Design pressure	
a	Circuit breaker	
b	Other compartments	
ix	Rated filling pressure	
a	Circuit breaker	
b	Other compartments	
x	Type tested pressure.	
a	Circuit breaker	
b	Other compartments	
xi	Routine test pressure	
a	Circuit breaker	
b	Other compartments	
xii	Operating pressure of PRD	
a	Circuit breaker	
b	Other compartments	
xiii	Alarm Pressure	
a	Circuit breaker	
b	Other compartments	
c	CB lock out Pressure	
d	Over pressure signaling	
xiv	Maximum SF6 Gas leakage rate, in % per year	
xv	Density Monitor to be provided for each Individual gas compartment.	
<b>20</b>	<b>Circuit Breaker</b>	
i	Applicable standard	
ii	Type	
iii	Designation	
iv	Operating Mechanism type	
v	Nos. of phases	
vi	Rated current in Amp	

vii	Mechanical Endurance class	
viii	Electrical Endurance class	
ix	Restrike probability class	
x	Rated SC breaking current	
xi	Rated SC breaking current - single phase test	
xii	Rated Line charging breaking current	
xiii	Rated Cable charging breaking current	
xiv	Capacitor bank switching capability,	
	BC1	
	BC2	
xv	Inductive current	
xvi	Reactive current	
xvii	Out of phase making & breaking current	
xviii	Rated short line fault current	
xix	TRV characteristic	
xx	First Pole to Clear factor	
xxi	Nos. of interrupters per phase	
xxii	Type of arc control device provided, if any	
xxiii	Type of arcing contacts	
xxiv	Material of main contact	
xxv	Material of Arcing contacts	
xxvi	Filter material	
xxvii	Timings of operations	
a	- Opening at nominal control voltage	
	- Opening at minimum control voltage	
b	Closing time at nominal control voltage	
xxviii	Maximum pole discrepancy time	
	Tripping	
	Closing	
xxix	Rated operating duty cycle	
xxx	Tripping Coils	
	- No of coils	
	- Rated Voltage	
	- Rated Current	
	- Rated Watts	
	- Resistance	

xxxi	Closing Coil	
	- Rated Voltage	
	- Rated Current	
	- Rated Watts	
	- Resistance	
xxxii	Spring Charging Motor	
	- Rated Voltage	
	- Rated Current	
	- Rated Watts	
xxxiii	Spring charging time at rated Aux supply	
xxxiv	Spring charging time at min Aux supply	
xxxv	Maintenance required after nos. of operation at	
i	No load	
ii	Rated current	
iii	25% of rated SC current	
iv	50% rated SC current	
v	Rated SC current	
e	Provision of anti pumping	
f	No of operations after switching off of motor Aux. supply	
xxxvi	Provision of Manual trip	
xxxvii	Electrical interlocking	
xxxviii	Padlocking	
xxxix	Type of Operation counter provided	
<b>21</b>	<b>DISCONNECTORS</b>	
i	Applicable standards	
ii	Type	
iii	Rated current in Amp for	
	- Bus disconnector	
	- Line disconnector	
	- Transformer disconnector	
	- PT disconnector	
iv	Maximum Current that can be safely interrupted by the Isolator (Amp).	
	- Inductive	
	- Capacitive	
v	Rate Short time withstand Current in kA, for 3 sec	
vi	Rated peak short time Current, kAp	

vii	Rated bus charging current, in Amp	
viii	Type of contacts	
ix	Material of contacts	
x	Current Density at minimum cross section (A/mm <sup>2</sup> )	
xi	Rated lightning impulse withstand voltage across the open gap, kVp	
xii	Rated Power Freq withstand voltage across the open gap, kVrms	
xiii	Mechanical Endurance class	
xiv	Type of Operating Mechanism	
xv	Operating Motor details	
	- Type	
	- Rated Voltage	
	- Rated Current	
	- Rated Watts	
xvi	Operating Time	
	- Closing	
	- Opening	
xvii	Mechanical indication on drive shaft	
<b>22</b>	<b>Maintenance Grounding Switch</b>	
i	Applicable standards	
ii	Type	
iii	Rate Short time withstand Current in kA, for 3 sec	
iv	Rated peak short time Current, kAp	
v	Rated lightning impulse withstand voltage across the open gap, kVp	
vi	Rated Power Freq withstand voltage across the open gap, kVrms	
vii	Type of Operating Mechanism	
viii	Operating Motor details	
	- Type	
	- Rated Voltage	
	- Rated Current	
	- Rated Watts	
ix	Operating Time	
	- Closing	
	- Opening	
x	Mechanical indication on drive shaft	
<b>23</b>	<b>Fast Acting Grounding Switch</b>	

i	Applicable standards	
ii	Type	
iii	Rate Short time withstand Current in kA, for 3 sec	
iv	Rated peak short time Current, kAp	
v	Rated induced current switching capability	
	Rated capacitive current switching capability	
vi	Rated lightning impulse withstand voltage across the open gap, kVp	
vii	Rated Power Freq withstand voltage across the open gap, kVrms	
viii	Electrical Endurance class	
ix	Type of Operating Mechanism	
x	Operating Motor details	
	- Type	
	- Rated Voltage	
	- Rated Current	
	- Rated Watts	
xi	Operating Time	
	- Closing	
	- Opening	
xii	Mechanical indication on drive shaft	
<b>24</b>	<b>Current transformers</b>	
i	Type	
ii	Material	
iii	Position of Current Transformer	
iv	Reference Standard	
v	Rated Continuous thermal current	
vi	Rated Short Time current	
vii	Duration	
<b>a</b>	<b>Feeder Bay CT</b>	
i	Metering Core	
	- Ratio	
	- Output Burden	
	- Accuracy Class	
	- ISF	
ii	Protection Core -1	
	- Ratio	

	- Output Burden	
	- Accuracy Class	
	- ALF	
iii	Protection Core -2	
	- Ratio	
	- Output Burden	
	- Accuracy Class	
	- ALF	
b	<b>Transformer Bay CT</b>	
i	Metering Core	
	- Ratio	
	- Output Burden	
	- Accuracy Class	
	- ISF	
ii	Protection Core -1	
	- Ratio	
	- Output Burden	
	- Accuracy Class	
	- ALF	
iii	Protection Core -2	
	- Ratio	
	- Accuracy Class	
	- Minimum Knee Point Voltage at highest ratio	
	- Maximum Excitation Current at $V_k$	
	- Maximum Resistance at highest ratio	
iv	Protection Core -3	
	- Ratio	
	- Accuracy Class	
	- Minimum Knee Point Voltage at highest ratio	
	- Maximum Excitation Current at $V_k$	
	- Maximum Resistance at highest ratio	
c	<b>Bus Coupler Bay CT</b>	
i	Metering Core	
	- Ratio	
	- Output Burden	
	- Accuracy Class	
	- ISF	
ii	Protection Core -1	
	- Ratio	
	- Burden	



	- Accuracy Class	
	- ALF	
iii	Protection Core -2	
	- Ratio	
	- Burden	
	- Accuracy Class	
	- ALF	
<b>25</b>	<b>Voltage Transformer</b>	
	Type	
	Position of Voltage Transformer	
	Reference Standard	
	Rated Over Voltage Factor - Continuous	
	Short Time Over Voltage Factor	
	Duration	
	Partial Discharge Level	
	Thermal Rating of Primary Winding	
<b>26</b>	<b>Line &amp; Bus VT</b>	
i	Metering Core	
	- Ratio	
	- Output Burden	
	- Accuracy Class	
ii	Protection Core -1	
	- Ratio	
	- Output Burden	
	- Accuracy Class	
iii	Protection Core -2	
	- Ratio	
	- Output Burden	
	- Accuracy Class	
<b>27</b>	<b>Enclosed Surge Arrester</b>	
ii	Name of Manufacturer	
iii	Arrester Class & Type (with mfr type designation)	
iv	Applicable Standard	
v	Rated system voltage (kV)	
vi	Rated Arrester Voltage (kV)	
vii	Max continuous operating voltage (MCOV) – (kV)	
viii	i)Nominal Discharge Current (KA) with 8/20 Micro-second wave	

	ii)Max resistive component of cont current at MCOV-mA crest	
	iii)Max capacitive component of cont current at MCOV -mA crest	
ix	Long Duration Discharge Class	
x	Min. Energy Discharge Capability (KJ/KV rating)	
xi	Max. switching current impulse residual voltage (KVP) 1000 Amps 250 Amps	
xii	Pressure Relief Class KA (rms)	
xiii	High Current short duration impulse withstand level with 4/10 micro-second wave (KA) peak	
xiv	Over –voltage withstand capability – KV	
	a) 100 Seconds	
	b) 10 Second	
	c) 1.0 Second	
	d) 0.1 Second	
	e) Reference Voltage (KV)	
	f) Reference Current (KA)	
xv	Surge counter	
xvi	Leakage monitor	
<b>28</b>	<b>Local Control Cubical</b>	
i	Name of Manufacturer (OEM of GIS)	
ii	Location in GIS	
iii	Material	
iv	Sheet Thickness	
v	Degree of Protection	
vi	Padlocking arrangement	
vii	Major components of LCC	
	- Bay control mimic diagram	
	- Control Switches	
	- Indicating lamps	
	- Position indicators	
	- Annunciation scheme	
	- Auxiliary relays	
	- Contact multiplication relays	
	- System parameters display	
	- Heater with thermostat	

	- Interface terminal blocks for relaying & protection	
<b>29</b>	<b>GIS to Line connection</b>	
i	Nos of XLPE cable can be terminated	
ii	Type of cable termination required	
<b>30</b>	<b>GIS to Transformer connection</b>	
i	Nos of XLPE cable can be terminated	
ii	Type of cable termination required	
<b>31</b>	<b>Maintenance</b>	
i	Maximum down time for replacement or removal of any part	
ii	Maximum down time for degassing and re-filling the biggest compartment	
iii	Time between two refilling of SF6 gas.	
iv	Recommended period for overhauling	
v	Operation and Maintenance manual attached	
vi	Nearest local service centre	
vii	Minimum time of availability of local service	
viii	Availability of spares at local service centre	
ix	List of recommended spares attached?	
x	List of recommended special tools, etc attached?	
xi	List of commission spares attached?	
xii	List of maintenance spares attached?	

## **72. Provision for Grouting/Support for HT & LT Lines**

### **33kV Lines**

Support foundation:

Cement concrete in mixture 1 part cement, 3-part coarse sand, 6 part 40mm size aggregate stone chips (1:3:6) shall be used in all the types of 33 kV line supports.

While erecting supports (poles), shuttering must be used for concreting so that proper quantity of cement concrete mixture be used and assessed during inspection. During concreting proper compaction by means of mobile vibrator be provided. While starting work of support erection, gang wise shuttering and mobile vibrator shall be offered for inspection to Project Manager. While erecting support, mercury level gauge must be used to ensure vertical erection of support.

250mm dia X 12" inch size muffing shall be provided on steel tubular and H-Beam poles to prevent direct entry of rainwater along the poles. Cement Concrete of 1:2:4 (1 part Cement, 2 parts coarse sand and 4 parts 20mm aggregate stones chips) shall be used for individual poles.

Steel plate shall be used in steel tubular poles and cement concrete reinforced plate shall be used as base plate for PCC poles.

### **11kV Lines**

Support foundation:

Cement concrete in mixture 1 part cement, 3-part coarse sand, 6 part 40 mm size aggregate stone chips (1:3:6) shall be used in steel tubular poles and H-Beam 11 kV line supports.

In rural areas, PCC pole pit shall be refilled with 200 mm average size of bolder mixed with excavated earth. Proper ramming shall be performed for better compaction. All Double pole (DP), Triple pole (TP), cut point poles, Distribution Transformer substation poles and poles erected on water logging area shall be grouted using cement concrete mixture similar to H-Beam & Tubular poles. Prior approval of Project Manager shall be obtained for concreting of PCC poles in water logging area. While preparing route survey report, water logging areas shall be earmarked.

While erecting supports (poles), shuttering must be used for concreting so that proper quantity of cement concrete mixture be used and assessed during inspection. During concreting proper compaction by means of mobile vibrator be provided. While starting work of support erection, gang wise shuttering and mobile vibrator shall be offered for inspection to Project Manager. While erecting support, mercury level gauge must be used to ensure vertical erection of support.

250mm dia X 12" inch size muffing shall be provided on steel tubular and H-Beam poles to prevent direct entry of rainwater along the poles. Cement Concrete of 1:2:4 (1 part Cement, 2 parts coarse sand and 4 parts 20mm aggregate stones chips) shall be used for individual poles.

Steel plate shall be used in steel tubular poles and cement concrete reinforced plate shall be used as base plate for PCC poles.

### **LT Lines**

Support foundation:

Cement concrete in mixture 1 part cement, 3-part coarse sand, 6 part 40 mm size aggregate stone chips (1:3:6) shall be used in steel tubular poles and H-Beam LT line supports.

In rural areas, PCC pole pit shall be refilled with 200 mm average size of bolder mixed with excavated earth. Proper ramming shall be performed for better compaction. PCC pole at cut point and PCC poles erected on water logging area shall be grouted using cement concrete mixture similar to H-Beam & Tubular poles. Prior approval of Project Manager shall be obtained for concreting of PCC poles in water logging area. While preparing route survey report, water logging areas shall be earmarked.

While erecting supports (poles), shuttering must be used for concreting so that proper quantity of cement concrete mixture be used and assessed during inspection. During concreting proper compaction by means of mobile vibrator be provided. While starting work of support erection, gang wise shuttering and mobile vibrator shall be offered for inspection to Project Manager. While erecting support, mercury level gauge must be used to ensure vertical erection of support.

250mm dia X 12" inch size muffing shall be provided on steel tubular and H-Beam poles to prevent direct entry of rain water along the poles. Cement Concrete of 1:2:4 (1 part Cement, 2 parts coarse sand and 4 parts 20mm aggregate stones chips) shall be used for individual poles.

Steel plate shall be used in steel tubular poles and cement concrete reinforced plate shall be used as base plate for PCC poles.

**73. Specification for Wide Parallel Beam GI Poles 160X160mm (11Mtr & 13Mtr)****1. Wide Parallel Beam GI Poles (160x160 mm) – 30.44kg per meter****1.1. Scope:**

This specification covers design, manufacture, testing and supply of 160mm x 160mm GI WPB 11 Meter. &13 Meter long having unit weight of 30.44Kg per Meter.

**1.2. Standards:**

The GI WPB Pole shall comply with the requirements of latest issue of IS – 12778:2004 & IS 2062:2011 or latest amendments if any with Grade destination E350 (Tensile strength: 440N/mm<sup>2</sup>) & Quality “A” in respect of “dimension & section properties” and steel specification respectively.

**1.3. Climatic Conditions:**

The climatic conditions at site under which the store shall operate satisfactory, are as follows

Maximum temperature of air in shade	45°C
Maximum temperature of air in shade	0°C
Maximum temperature of air	50°C
Maximum rain fall per annum	2000mm
Maximum temperature of air in shade	45°C
Maximum ambient temperature	45°C
Maximum humidity	100%
Av. No. of thunder storm days per annum	70
% Av. No. of dust storm per annum	20
Av. Rain fall per annum	150mm

**1.4. Wide Parallel Beam**

- a. The Wide Parallel Beam support structures shall be fabricated from mild steel, grade A and in lengths dictated by design parameters. The WPB, may include, but shall not be limited to the following sizes:

**1.5. Dimensions and Properties:**

Sl No.	General Technical Particulars	WPB 160 x 160 mm X 30.44Kg	To be filled by Bidder
--------	-------------------------------	-------------------------------------	------------------------

1	Length of Joist in Mtr with +100mm/-0% Tolerance	13 mtr / 11Mtr	
2	Weight in kg/m with $\pm 2.5\%$ Tolerance	30.44 Kg./Mtr.	
3	Sectional Area (cm <sup>2</sup> )	38.8	
4	Depth(D) of Section (mm) with +3.0mm/ - 3.0mm Tolerance a	152mm	
5	Width(B) of Flange(mm) $\pm 0.7\text{mm}$ Tolerance	160mm	
6	Thickness of Flange (Tf) (mm) with $\pm 1.59\text{mm}$ Tolerance		
7	Thickness of Web(Tw) (mm) with $\pm 1.0\text{mm}$ Tolerance	6	
8	Corner Radius of fillet or root (R1) (mm)	15	
9	Corner Radius of Toe (R2) (mm)		
10	Moment of Inertia		
	Ixx (cm <sup>4</sup> )	1673	
	Iyy (cm <sup>4</sup> )	615.6	
11	Radius of Gyration (cm)		
	Rxx	6.57	
	Ryy	3.98	
	Modulus of Section Zxx(cm <sup>3</sup> )		
	Zyy(cm <sup>3</sup> )	220.1	

	Zxx(cm <sup>3</sup> )	76.9	
	GI Base Plate in mm	300 x 300 x 12	
	GI Stiffener Flange	150 x 60 x 6	
	GI Stiffener Web	150 x 100 x 6	



### 1.6. Mechanical properties:

Tensile Test :	Requirement as per IS:2062/ 2011 Grade-A	To be filled by Bidder
Yield Stress (Mpa)	Min 350	
Tensile Strength(Mpa)	Min 490	
Lo=(5.65 So)Elongation%	Min 22	
Bend Test	Shall not Crack	

**Supplier has to supply Baseplate with dimension 300mm x 300mm x 12mm Thickness along with Stiffener 150 x60x6 & 150x 100x6. Drawing to be submitted by BA for approval.**

However, In case of any discrepancy between the above data & the relevant IS, the values indicated in the IS shall prevail. The Acceptance Tests shall be carried out as per Relevant IS.

### 1.7. Galvanising

WPB Pole shall be hot dip galvanized, are as following:

All galvanizing shall be carried out by the hot dip process, in accordance with Specification IS 2629. However, high tensile steel nuts, bolts and spring washer shall be electro galvanized to Service Condition 4. The zinc coating (785 gms per sq.mt / 100Micron) shall be smooth, continuous and uniform. It shall be free from acid spot and shall not scale, blister or be removable by handling or packing.

There shall be no impurities in the zinc or additives to the galvanic bath which could have a detrimental effect on the durability of the zinc coating.

Before picking, all welding, drilling, cutting, grinding and other finishing operations must be completed and all grease, paints, varnish, oil, welding slag and other foreign matter completely removed. All protuberances which would affect the life of galvanizing shall also be removed.

The weight of zinc deposited shall be in accordance with that stated in Standard IS 2629 and shall not less than  $0.785\text{kg/mtr}^2$  with a minimum thickness of 100 microns.

Parts shall not be galvanized if their shapes are such that the pickling solutions cannot be removed with certainty or if galvanizing would be unsatisfactory or if their mechanical strength would be reduced. Surfaces in contact with oil shall not be galvanized unless they are subsequently coated with an oil resistant varnish or paint.

In the event of damage to the galvanizing the method used for repair shall be subject to the approval of the Engineer in Charge or that of his representative.

**In no case the repair of galvanization on site will be permitted.**

The threads of all galvanized bolts and screwed rods shall be cleared of spelter by spinning or brushing. A die shall not be used for cleaning the threads unless specifically approved by the Engineer in Charge. All nuts shall be galvanized. The threads of nuts shall be cleaned with a tap and the threads oiled.

Partial immersion of the work shall not be permitted and the galvanizing tank must therefore be sufficiently large to permit galvanizing to be carried out by one immersion.

After galvanizing no drilling or welding shall be performed on the galvanized parts of the equipment excepting that nuts may be threaded after galvanizing. To avoid the formation of white rust galvanized materials shall be stacked during transport and stored in such a manner as to permit adequate ventilation. Sodium dichromate treatment shall be provided to avoid formation of white rust after hot dip galvanization. The galvanized steel shall be subjected to test as per IS-2633.

Quality of Hot Dip Galvanisation should comply with IS 2629, ISO1461 & should be guaranteed for any type of damage due to harsh climatic condition for 10Years. These poles are to be used in coastal areas of Odisha where climate is hot, humid & saline. These areas are prone to flood & frequent rainfall.

#### **1.8. Embossing on each WPB Pole:**

Following distinct non-erasable embossing is to be made on each WPB Poles to be supplied to DOSCOM under this Tender.

**Name of the Owner – DISCOM B.I.S Logo (ISI Mark).**

**Size of the WPB Pole:**

**Name of manufacture: WO No & Dt.**

#### **1.9. Drawing Submission and Approval**

The relevant drawings and GTPs need to be submitted within two weeks of receipt of firm purchase order by the successful bidder to DISCOM for approval. In case, re-submission of drawings is required on request of DISCOM, same needs to be submitted back to DISCOM within 5 days of such request.

#### **1.10. Guarantee Period**

The Guarantee Period will be equipment/service/work specific and shall be as specified in the Standard Specifications of DISCOM for the equipment/material/service/work and where standard specifications are not part of contract documents or guarantee period is not specified in the standard specifications, the guarantee period shall be as per the Special Terms and Conditions of the Contract. In case of no mention of the guarantee period in standard specifications or SCC Guarantee Period will be 12 Months from the Date of Commissioning or 24 months from the date of delivery of final lot of supplies made, whichever is earlier.

### 1.11. Drawing

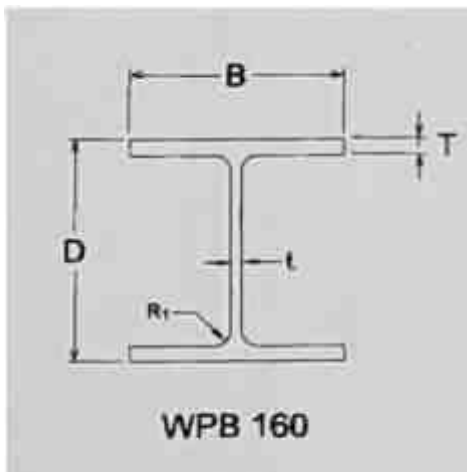

Section	Mass (kg/m)	Sectional Area (cm <sup>2</sup> )	Dimensions (mm)						
			D (Depth)	B (width)	t (web thick)	T (flange thick)	Flange slope, a deg.	R <sub>1</sub> Root radius	R <sub>2</sub>
WPB 160	30.44	38.78	152	160	6	9	-	15	-

### 1.12. Inspection, Dispatch, Acceptance & Testing:

#### a) Inspection:

The supplier shall submit their offer for inspection of materials at least 10 days before actual date of inspection proposed at their factory premises. The Inspectors duly authorized by the purchaser shall be deputed to conduct the Inspection & Testing of WPB pole at the suppliers' works before dispatch, on receipt of offer for inspection from the supplier. The purchaser at his

discretion may engage a third party for above inspection. The Pre-dispatch inspection shall be carried out as per relevant ISS / Tender Specification / GTP enclosed in the Purchase Order. The supplier shall extend all necessary assistance / co-operation to the authorized inspectors of the buyers.

b) Despatch instruction:

The authorized inspectors shall furnish their Inspection Report to the undersigned for approval. On receipt of successful Pre dispatch inspection, the undersigned shall issue dispatch instruction to the supplier. On receipt of such dispatch instruction the materials shall be dispatched by the supplier to the consignee.

c) Acceptance of materials:

However the lot of materials dispatched as above shall be accepted after due physical verification at our Stores in respect to dimensions & weight as per our GTP.

d) Random testing of materials supplied after delivery / acceptance:

In case any doubt arises in the quality of materials supplied, the authority reserves the Right to take out a Sample Test Piece of the WPB Pole from a lot delivered at our Stores, for relevant tests in the Govt. approved Testing Laboratory of their choice for confirmation of the Chemical & Mechanical properties of the materials supplied as per IS. The sample test piece so collected by the authorized representative of DISCOM shall be done in presence of the authorized representative of the supplier. If the materials fail to confirm the specified tests given in the relevant IS, the entire lot of the supplied materials shall be rejected & the financial loss incurred by the purchaser as ascertained by the authority shall be recovered from the supplier.

### **1.13. Rejection of Materials:**

In the event, any of the materials / equipment supplied by the Contractor is found defective due to faulty design, bad workmanship, bad materials used or otherwise not in conformity with the requirements of the Specification, the Purchaser shall either reject the materials / equipment or ask the Contractor in writing to rectify the same. The Contractor on receipt of such notification shall either rectify or replace the defective equipment free of cost to the Purchaser. If the Contractor fails to do so, the Purchaser may :

- a) At its option replace or rectify such defective equipment and recover the extra costs so Involved from the Contractor plus fifteen percent and / or.
- b) Terminate the contract for balance work / supplies with enforcement of penalty Clause as per contract for the un-delivered goods and with forfeiture of Performance Guarantee/ Composite Bank Guarantee.
- c) Acquire the defective equipment / materials at reduced price considered equitable under the circumstances.

## **2. Wide Parallel Beam GI Poles (160x160 mm) – 23.84 kg per meter**

### **2.1. Scope:**

This specification covers design, manufacture, testing and supply of 160mm x 160mm GI WPB 11 Meter. & 13 Meter long having unit weight of 23.84 Kg per Meter.

### **2.2. Standards:**

The GI WPB Pole shall comply with the requirements of latest issue of IS – 12778:2004 & IS 2062:2011 or latest amendments if any with Grade destination E350 (Tensile strength: 440N/mm<sup>2</sup>) & Quality “A” in respect of “dimension & section properties” and steel specification respectively.

### **2.3. Climatic Conditions:**

The climatic conditions at site under which the store shall operate satisfactory, are as follows

Maximum temperature of air in shade	45°C
Maximum temperature of air in shade	0°C
Maximum temperature of air	50°C
Maximum rain fall per annum	2000mm
Maximum temperature of air in shade	45°C
Maximum ambient temperature	45°C
Maximum humidity	100%
Av. No. of thunder-storm days per annum	70
% Av. No. of dust storm per annum	20
Av. Rain fall per annum	150mm

### **2.4. Wide Parallel Beam**

- a. The Wide Parallel Beam support structures shall be fabricated from mild steel, grade A and in lengths dictated by design parameters. The WPB, may include, but shall not be limited to the following sizes:

### 2.5. Dimensions and Properties:

Sl No.	General Technical Particulars	WPB 160 x 160 mm X 23.84Kg	To be filled by Bidder
1	Length of Joist in Mtr with +100mm/-0% Tolerance	13 mtr / 11Mtr	
2	Weight in kg/m with $\pm 2.5\%$ Tolerance	23.84 Kg./ Mtr.	
3	Sectional Area (cm <sup>2</sup> )	30.37	
4	Depth(D) of Section (mm) with +3.0mm/-3.0mm Tolerance a	148mm	
5	Width(B) of Flange(mm) $\pm 0.7$ mm Tolerance	160mm	
6	Thickness of Flange (Tf) (mm) with $\pm 1.5$ mm Tolerance	7	
7	Thickness of Web(Tw) (mm) with $\pm 1.0$ mm Tolerance	4.5	
8	Corner Radius of fillet or root (R1) (mm)	15	
9	Corner Radius of Toe (R2) (mm)		
10	Moment of Inertia		
	Ixx (cm <sup>4</sup> )	1282.88	
	Iyy (cm <sup>4</sup> )	478.73	
11	Radius of Gyration (cm)		
	Rxx	6.50	

Sl No.	General Technical Particulars	WPB 160 x 160 mm X 23.84Kg	To be filled by Bidder
	Ryy	3.97	
	Modulus of Section Zxx(cm <sup>3</sup> )		
	Zyy(cm <sup>3</sup> )	173.36	
	Zxx(cm <sup>3</sup> )	59.84	
	GI Base Plate in mm	300 x 300 x 12	
	GI Stiffener Flange	150 x 60 x 6	
	GI Stiffener Web	150 x 100 x 6	

### Minimum Guarantee Required for materials

The bidder shall ensure that the materials supplied by them

## 2.6. Mechanical properties:

Tensile Test :	Requirement as per IS:2062/ 2011 Grade-A	To be filled by Bidder
Yield Stress (Mpa)	Min 350	
Tensile Strength(Mpa)	Min 490	
Lo=(5.65 So)Elongation%	Min 22	
Bend Test	Shall not Crack	

**Supplier has to supply Baseplate with dimension 300mm x 300mm x 12mm Thickness along with Stiffener 150 x60x6 & 150x 100x6. Drawing to be submitted by bidder for approval.**

However, In case of any discrepancy between the above data & the relevant IS, the values indicated in the IS shall prevail. The Acceptance Tests shall be carried out as per Relevant IS.

## 2.7. Galvanising

WPB Pole shall be hot dip galvanized, are as following:

All galvanizing shall be carried out by the hot dip process, in accordance with Specification IS 2629. However, high tensile steel nuts, bolts and spring washer shall be electro galvanized to Service Condition 4. The zinc coating (785 gms per sq.mt / 100Micron) shall be smooth, continuous and uniform. It shall be free from acid spot and shall not scale, blister or be removable by handling or packing.

There shall be no impurities in the zinc or additives to the galvanic bath which could have a detrimental effect on the durability of the zinc coating.

Before picking, all welding, drilling, cutting, grinding and other finishing operations must be completed and all grease, paints, varnish, oil, welding slag and other foreign matter completely removed. All protuberances which would affect the life of galvanizing shall also be removed.

The weight of zinc deposited shall be in accordance with that stated in Standard IS 2629 and shall not less than  $0.785\text{kg/mtr}^2$  with a minimum thickness of 100 microns.



Parts shall not be galvanized if their shapes are such that the pickling solutions cannot be removed with certainty or if galvanizing would be unsatisfactory or if their mechanical strength would be reduced. Surfaces in contact with oil shall not be galvanized unless they are subsequently coated with an oil resistant varnish or paint.

In the event of damage to the galvanizing the method used for repair shall be subject to the approval of the Engineer in Charge or that of his representative.

**In no case the repair of galvanization on site will be permitted.**

The threads of all galvanized bolts and screwed rods shall be cleared of spelter by spinning or brushing. A die shall not be used for cleaning the threads unless specifically approved by the Engineer in Charge. All nuts shall be galvanized. The threads of nuts shall be cleaned with a tap and the threads oiled.

Partial immersion of the work shall not be permitted and the galvanizing tank must therefore be sufficiently large to permit galvanizing to be carried out by one immersion.

After galvanizing no drilling or welding shall be performed on the galvanized parts of the equipment excepting that nuts may be threaded after galvanizing. To avoid the formation of white rust galvanized materials shall be stacked during transport and stored in such a manner as to permit adequate ventilation. Sodium dichromate treatment shall be provided to avoid formation of white rust after hot dip galvanization. The galvanized steel shall be subjected to test as per IS-2633.

Quality of Hot Dip Galvanisation should comply with IS 2629, ISO1461 & should be guaranteed for any type of damage due to harsh climatic condition for 10Years. These poles are to be used in coastal areas of Odisha where climate is hot , humid & saline. These areas are prone to flood & frequent rainfall.

## **2.8. Embossing on each WPB Pole:**

Following distinct non-erasable embossing is to be made on each WPB Poles to be supplied to DOSCOM under this Tender.

**Name of the Owner – DISCOM B.I.S Logo (ISI Mark).**

**Size of the WPB Pole:**

**Name of manufacture: WO No & Dt.**

## **2.9. Drawing Submission and Approval**

The relevant drawings and GTPs need to be submitted within two weeks of receipt of firm purchase order by the successful bidder to DISCOM for approval. In case, re-submission of drawings is required on request of DISCOM, same needs to be submitted back to DISCOM within 5 days of such request.

## **2.10. Guarantee Period**

The Guarantee Period will be equipment/service/work specific and shall be as specified in the Standard Specifications of DISCOM for the equipment/material/service/work and where standard specifications are not part of contract documents or guarantee period is not specified in the standard specifications, the guarantee period shall be as per the Special Terms and Conditions of the Contract. In case of no mention of the guarantee period in standard specifications or SCC Guarantee Period will be 12 Months from the Date of Commissioning or 24 months from the date of delivery of final lot of supplies made, whichever is earlier.

### 2.11. Drawing

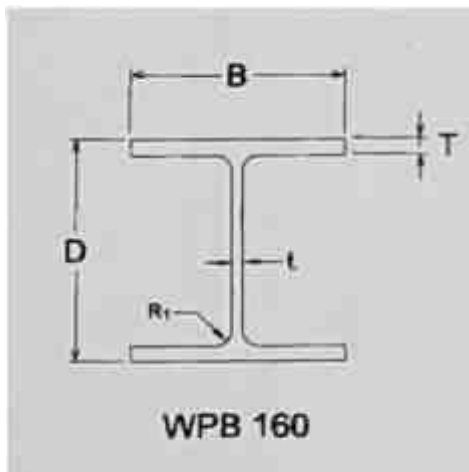

Section	Mass (kg/m)	Sectional Area (cm <sup>2</sup> )	Dimensions (mm)						
			D (Depth)	B (width)	t (web thick)	T (flange thick)	Flange slope, a deg.	R <sub>1</sub> Root radius	R <sub>2</sub>
WPB 160	23.84	30.37	148	160	4.5	7	-	15	-

**74. Minimum Guarantee/Warranty Required for supplied Materials**

Notwithstanding any of the specifications above, the minimum Guarantee/Warranty requirement for major materials shall be as per below table:

<b>Sr. No.</b>	<b>Material</b>	<b>Gurantee / Warranty</b>
1	Power Transformers	60 months from Commissioning
2	Single Phase Oil Immersed Distribution Transformers (Outdoor Type)	60 months from Commissioning
3	3-Phase Distribution Transformers 11 or 33 kV/433-250V (Outdoor Type)	60 months from Commissioning
4	11 & 33 KV Outdoor Type Current Transformer	36 months from Commissioning
5	33 & 11 kV Outdoor Type Potential Transformer	36 months from Commissioning
6	11 kV AND 33 kV Vacuum Circuit Breakers	36 months from Commissioning
7	11 kV 350MVA 1250 AMP VCB Switchgear Panels (MC VCB) - Indoor	36 months from Commissioning
8	Batteries and Charger	36 months from Commissioning
9	LT upto (1100 V) XLPE Insulated	36 months from Commissioning
10	LT Aerial Bunched Cables	36 months from Commissioning
11	XLPE Power Cables (11kV & 33 kV)	36 months from Commissioning

**75. Letters for Amendment in Technical Specification**

The bidder shall ensure that due attention has been given in supply of materials and erection works as per latest amendments issued by REC from time to time. Some amendment letters are attached herewith for reference of the bidder.



रुरल इलेक्ट्रिफिकेशन कारपोरेशन लिमिटेड  
Rural Electrification Corporation Limited

(भारत सरकार का उद्यम) / A Government of India Enterprise

Regd. Office: Core-4 SCDPE Complex, 7, Lodhi Road, New Delhi 110 003

Tel: 011-24369851 FAX: 011-24369850, Email: [ddugjyquality@gmail.com](mailto:ddugjyquality@gmail.com)

CIN: L40101DL1969GO1005095 Website: [www.recindia.nic.in](http://www.recindia.nic.in)

Ref. No. REC/DDUGJY/SBD/ 749.

Dated: 27-07-2016

To  
All Project Implementing Agencies  
(DISCOMs/SEBs/CPSUs/Power Departments)  
RE-DDUGJY Projects

**Sub: Amendment in Technical Specification of 11 kV Composite Insulators -reg**

Sir/Madam,

This has reference to the Standard Bidding Document Vol -III Section-I Technical Specification of 11 kV Composite Insulators to be used under DDUGJY scheme. The clause no. 5 of technical specification has been amended which is as here under:

Existing Provision in the Clause	Amended Clause
The minimum shed diameter for long rod insulator should be 100 mm	The minimum shed diameter for long rod insulator should be between 75-100 mm

This is for kind information please.

Yours sincerely,

(G S Bhati)  
General Manager (DDUGJY)

Copy to:  
ZM/CPM- Please circulate to PIAs in the states of your purview.

**Zonal Offices** : Hyderabad, Kolkata, Mumbai, Panchkula & Lucknow  
**Project Offices** : Bangalore, Bhopal, Bhubaneswar, Chennai, Guwahati, Jaipur, Jammu, Patna, Ranchi, Shillong, Shimla, Thiruvananthapuram & Vadodara  
**Sub Offices** : Dehradun, Raipur  
**Training Centre** : Central Institute for Rural Electrification (CIRES), Hyderabad





## रूरल इलेक्ट्रीफिकेशन कारपोरेशन लिमिटेड Rural Electrification Corporation Limited

(भारत सरकार का उद्यम) / (A Government of India Enterprise)

Regd. Office: Core-4, SCOPE Complex, 7 Lodhi Road, New Delhi 110 003

Tel: +91-11-4102 0101 Fax: +91 11 2436 0544 E-mail: reccorp@recindia.nic.in

CIN : L40101DL1969GOI005095 Website: www.recindia.nic.in

Ref. No. REC/DDUGJY/SBD/७७०

Dated: 05-08-2016

To

All Project Implementing Agencies  
(DISCOMs/SEBs/CPSUs/Power Departments)  
RE-DDUGJY Projects

### Sub: Amendment in Technical Specification of Piercing Connector -reg

Sir/Madam,

This has reference to the technical Specification of Piercing Connector to be used under RE-DDUGJY (erstwhile RGGVY) XII Plan & DDUGJY schemes. The clause no. 5.4.1 of technical specification which shall constitute Acceptance Tests for Insulation Piercing Connectors (IPC) has been amended which is as here under:

Existing Provision in the Clause	Amended Clause
<ul style="list-style-type: none"> <li>• Visual</li> <li>• Dimensional (as per SCD and overall dimensions submitted with Tender Offer)</li> <li>• <b>Electrical Ageing Test</b></li> <li>• Dielectric and Water Tightness Test.</li> <li>• Mechanical Tightening Test</li> <li>• Effect of Tightening on Main Core</li> <li>• Effect of Tightening on Branch Core</li> </ul>	<ul style="list-style-type: none"> <li>• Visual</li> <li>• Dimensional (as per SCD and overall dimensions submitted with Tender Offer)</li> <li>• Dielectric and Water Tightness Test.</li> <li>• Mechanical Tightening Test</li> <li>• Effect of Tightening on Main Core</li> <li>• Effect of Tightening on Branch Core</li> </ul>

This is for kind information please.

Yours sincerely,

(G S Bhati)

Executive Director (DDUGJY)

Copy to:

1. ZM/CPM- Please circulate to PIAs in the states of your purview.

**Zonal Offices** : Hyderabad, Kolkata, Mumbai, Panchkula & Lucknow  
**Project Offices** : Bangalore, Bhopal, Bhubaneswar, Chennai, Guwahati, Jaipur, Jammu  
 Patna, Ranchi, Shillong, Shimla, Thiruvananthapuram & Vadodara  
**Sub Offices** : Dehradun, Raipur  
**Training Centre** : Central Institute for Rural Electrification (CIRE), Hyderabad



एक कदम स्वच्छता की ओर

No. REC/DDUGJY/SBD/DTR-TS/ 969

Dated: 29.09.2016

To,

All PIAs /DISCOMs/Power Deptt.

**Subject: Methodology of Loss Capitalisation in Technical Specification of Distribution Transformer under DDUGJY -reg.**

Dear Ma'M / Sir,

Ministry of Power vide OM No 44/15/2015 dated 14.08.2015 had formed two committees viz. Committee 'A' & 'B' to facilitate and handhold states in mobilizing major materials with Standard Technical Specifications at competitive prices through a transparent bidding process under DDUGJY / IPDS Schemes. Committee A had identified the major high value items viz., Power Transformers, Distribution Transformers, Conductor, AB Cables & Energy Meter, finalized their Technical Specification and aggregated the quantity.

During the meeting held on June 29, 2016 under the Chairmanship of Hon'ble MoS (IC) for Power, Coal and New & Renewable Energy, it was decided that states are free to procure the materials on their own, if it is felt that their rates are lower than CPP rates. Accordingly, REC vide letter no. REC/DDUGJY/NIMM/745 dated 26.07.2016 (copy enclosed) allowed full turnkey mode of execution under DDUGJY and revised Standard Bidding Documents for full turnkey execution were circulated to all States vide REC letter No. REC/DDUGJY/SBD/239 on 22.08.2016.

The Technical Specification of Distribution Transformer, finalized by Committee 'A', mentioned the methodology for computing total owning cost based on loss capitalization. Since it would be practically not feasible to implement the Loss Capitalisation methodology for tender evaluation in full turnkey projects, the methodology of Total Owning Cost based on Loss Capitalisation may not be insisted upon for full turnkey tenders. However, States opting to go for direct procurement of Distribution Transformers may take care of this methodology based on their State practice.

This is for kind information and further needful action please.

Thanking You.

Yours Sincerely,  
  
29/9/16  
G S BHATI

Executive Director (DDUGJY-III)

Copy for kind information to:

1. The ZMs/CPMs, REC ZOs/POs – to circulate to all PIAs in the states of their jurisdiction

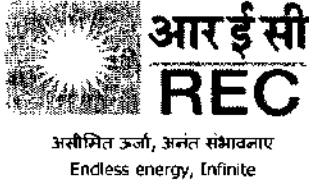

रुरल इलेक्ट्रिफिकेशन कारपोरेशन लिमिटेड

Rural Electrification Corporation Limited

(भारत सरकार का उद्यम)/ A Government of India Enterprise)

Regd. Office: Core-4 SCOPE Complex, 7, Lodhi Road, New Delhi 110 003

Tel: 011-24369851 FAX: 011-24369850 , Email:- [ddugjyquality@gmail.com](mailto:ddugjyquality@gmail.com)

CIN: L40101DL1969GO1005095 Website: [www.recindia.nic.in](http://www.recindia.nic.in)

No. REC/DDUGJY/SBD/2017-18 / ~~1129~~

Dated: 15.05.2017

To,

All Project Implementing Agencies  
DISCOMs /Power Deptt./ SEBs/CPSUs

**Subject:** Regarding Technical Specifications of LTDB in Standard Bidding Documents for DDUGJY

Ma'M / Sir,

This has reference to revised Standard Bidding Documents for full turnkey contracts under DDUGJY & IPDS circulated vide letter No. REC/DDUGJY/SBD/239 dated 22.08.2016. The Technical Specification of LTDB (Low Tension Distribution Boxes) specifies metallic boxes using deep drawn methodology. In addition to this, "Low Tension Distribution Box (LTDB) can also be manufactured by sheet bending process for developing three side walls (from a single sheet) with top & bottom walls welded to the same and front door fabricated separately and hinged."

This is for kind information and further needful action please.

Thanking You,

Yours Sincerely,

G S BHATI

Executive Director (DDUGJY)

Copy for kind information to:

1. All ZM/CPM - Please circulate to PIAs in the states of your purview.

**Zonal Offices** : Hyderabad, Kolkata, Mumbai , Panchkula & Lucknow  
**Project Offices** : Bangalore, Bhopal, Bhubaneswar, Chennai, Guwahati, Jaipur, Jammu, Patna, Ranchi , Shillong, Shimla, Thiruvananthapuram & Vadodara  
**Sub Offices** : Dehradun, Raipur  
**Training Centre** : Central Institute for Rural Electrification (CIRES), Hyderabad





Date: 21.07.2017

REC/DDUGJY/SBD/2017/2148

To,  
All PIAs  
(States Discoms/Power Departments)

Sub: Modification in technical specification for CTs, PTs under DDUGJY Scheme.

Sir / Madam,

A representation was received from MPPKVCL seeking clarification in technical specification for CTs & PTs under DDUGJY scheme. In this connection, following modification has been made in the technical specification for CTs & PTs :

Sl No	TS Clause No	Existing Technical Specification	REC Comments / Clarification
1	TS for current Transformers Clause No. 4.7. (1)	The primary terminal shall be of standard size of 30mm dia X 80 mm length of heavily tinned(min. thickness 15 micron) electrolytic copper of 99.9% conductivity.	<u>Clause may be modified to :</u> The primary terminal shall be of <b>maximum</b> size of 30mm dia X 80 mm length of heavily tinned(min. thickness 15 micron) electrolytic copper of 99.9% conductivity. Manufacturer shall design the diameter of primary terminal keeping current density 1.6 A per sq. mm for the given capacity of CT.
2	TS for potential Transformers Clause No. 7	The secondary terminals studs shall be provided with at least 3 nuts and two plain washers. These shall be made of brass duly nickel plated. The min. stud outer dia shall be 10 mm & length 15 mm.	<u>Clause may be modified to :</u> The secondary terminals studs shall be provided with at least 3 nuts and two plain washers. These shall be made of brass duly nickel plated. The min. stud outer dia shall be <b>6 mm</b> & length 15 mm.
3	TS for metering units, Clause No.9	Brass rods 12mm dia for Primary and 6mm dia for secondary.	Keeping current density of 1.6 A per sq. mm size of rod may be designed by manufacturer for given CT / PT.

Sl No	TS Clause No	Existing Technical Specification	REC Comments / Clarification
4	TS for Metering Units, Clause No 10.b	Tank including top cover shall be Hot Dip Galvanized.	Existing clause of TS will prevail. However state may decide to use Hot dip galvanized / Epoxy paint tank for CT/PT unit as per their prevailing state practices.

This is for your kind information and necessary action please.

Thanking You,

Yours faithfully,



(A Veluchamy)  
Addl. General Manager  
DDUGJY-Q&FM

Copy for kind information to:

1. The Sr. CPM / CPM, REC Regional office, for kind information please.

REC/DDUGJY/SBD/TS/2017-18/D.No.3091

Dated: 25.08.2017

The Chairman / Managing Director / Chief Engineer  
All Project Implementing Agencies (PIA)/DISCOM/  
State Power Utilities/ Power Department

**Sub: Clarification in Technical Specifications of various equipment included in the Standard Bidding Document (SBD) of DDUGJY/IPDS**

Dear Sir/Madam,

Following clarification pertains to technical specification of DDUGJY scheme are hereby conveyed:

Sl. No.	Name of materials	Particulars	Provision in SBD	Amended Provision
1	Distribution Transformers	Vacuum type test on transformer tank	Transformer tank shall be subjected to specified vacuum. The tank designed for vacuum shall be tested at an internal pressure of 0.35 kg per sq. cm absolute (250 mm of Hg) for one hour. (clause no.-31.10- pgno-80)	"Vacuum Type Test on Transformer Tank" shall be carried out as per IS-1180 (Part-1): 2014 i.e. The transformer tank shall be subjected to air pressure 80 kPa for 30 minutes and vacuum of 250 mm of mercury for 30 minutes.
2	Power Transformers	Maximum temperature rise over ambient temperature for oil/winding above ambient temperature	Permissible Temperature rise over ambient temperature shall be as per IS-2026 (point no.-25 page no.-6)	The maximum temperature rise over ambient temperature for oil/winding above ambient temperature shall be as per IS-2026(Part-2):2010. i.e. Maximum temperature rise over ambient temperature for top oil measured by thermometer should be 50 degree C. and for winding measured by resistance should be 55 degree C
3	XLPE Power Cables	Bleeding blooming type test	Bleeding and blooming tests (for outer sheath) (clause no-6.0, pgno-367)	"Bleeding Blooming Test" is deleted for XLPE cables.

Sl. No.	Name of materials	Particulars	Provision in SBD	Amended Provision
4	Isolators & AB switches	Maximum temperature rise over ambient temperature.	The maximum temperature attained by any part of the equipment when in service at site under continuous full load conditions and exposed to the direct rays of Sun shall not exceed 45 degree above ambient (clause no.-4- pgno-488)	Maximum permitted temperature rise over ambient temperature will be as per Table-4 of IS-9921 (Part-2).
5	Power Transformers	Noise level measurement type test	Noise Level Measurement IEC 551 Table : 6 Transformer Type Tests ambient (clause no.-8.2.1 pgno-31)	No change
6	XLPE Power Cable	Drum length	All Power Cables shall be supplied in drum length of 1000 m. Each drum shall contain one continuous length of cable. Owner shall have the option of rejecting cable drums with shorter lengths. (clause no.-5.0 pgno-366)	Drum length for power cable shall be 200/300/500m as per requirement of utility/Discom.
7	11 kV AB Switch	Number of Post Insulator per stack	The complete set of three phase AB Switches shall have stacks of post insulators. 11KV AB Switches : 3 No. 11KV Post Insulator per stack (clause no.- 3 pgno-487)	For 11kV AB switch, one (1) no. 11 kV post insulator per stack shall be permitted.
8	33 kV AB Switch	Number of Post Insulator per stack	The complete set of three phase AB Switches shall have stacks of post insulators. 33KV AB Switches : 3	For 33kV AB Switch, two (2) no. 22 kV post insulator or 3 No 11 KV post Insulators shall be permitted in each stack

Sl. No.	Name of materials	Particulars	Provision in SBD	Amended Provision
			No. 33KV Post Insulator per stack (clause no.- 3 pgno-487)	
9	11 kV Isolator	Number of Post Insulator per stack	11 KV isolators shall comprise of three numbers 11 KV insulators per stack and 9 such stack shall be supplied with each isolator. (clause no.- 9 pgno-484)	Post insulators for the 11kV isolators shall comprise of one (01) no. 11kV insulator per stack and nine (9) such stack shall be supplied with each isolator.
10	33 kV Isolator	Number of Post Insulator per stack	33 KV isolators, two numbers 33 KV insulators per stack and 9 stacks shall be supplied with each isolator (clause no.- 9 pgno-484)	Post insulators for 33kV isolators shall comprise two (02) nos. of 22kV insulators or 3 No of 11 KV post insulators or One no 33kV post insulator per stack and nine (9) such stack shall be supplied with each isolator

This is issued with the approval of the competent authority

Thank you

Yours faithfully,

(A. Veluchamy)  
Addl. General Manager  
(DDUGJY-QA&FM)

Copy for uploading in DDUGJY web portal

REC/DDUGJY/SBD/2017-18/609

Date: 05.10.2018

To  
All Project Implementing Agencies,  
DDUGJY-RE Projects XII Plan & DDUGJY/IPDS Scheme

Sub: Amendments in technical specification of AB Cable Accessories and Insulation Piercing Connectors (IPC) provided in Standard Bidding Document for DDUGJY-RE 12 Plan and DDUGJY/IPDS scheme.

Sir,  
This has reference to the technical specifications of AB Cable accessories and Insulation Piercing Connectors (IPC) to be used DDUGJY-RE Projects XII Plan & DDUGJY/IPDS Schemes. In this connection, please find enclosed the amendments/corrections in clause 5.1.10.4, 5.2 & 5.3 of technical specification of AB Cable Accessories and Insulation Piercing Connectors (IPC) provided in Standard Bidding Document.

This is for information and further needful action please.

Yours sincerely,

  
G S BHATI

Executive Director (PMD-II/QA)

Copy to:  
Sr. CPM/CPM, REC RO/SO- with a request to please circulate to PIAs in the states of your purview.

**AMENDMENT PROPOSED IN TECHNICAL SPECIFICATIONS OF CABLE ACCESSORIES OF SBD (DDUGJY)**

SI No	Clause No. of SBD	Heading in clause	Provision as per Technical Specification of SBD	Amendments/ Recommendation
1	5.1.10.4	Insulation Piercing Connector (IPC)	<p>The following shall constitute Type Tests for IPC :</p> <ul style="list-style-type: none"> <li>• Electrical Ageing Test</li> <li>• Dielectric and Water Tightness Test.</li> <li>• Mechanical Tightening Test</li> <li>• Effect of Tightening on main Core</li> <li>• Effect of Tightening on Branch core</li> <li>• Over-current Test (if applicable) \</li> </ul>	<p>The following shall constitute Type Tests for IPC :</p> <ul style="list-style-type: none"> <li>• Electrical Ageing Test</li> <li>• Dielectric and Water Tightness Test.</li> <li>• Mechanical Tightening Test</li> <li>• Effect of Tightening on main Core</li> <li>• Effect of Tightening on Branch core</li> <li>• Over-current Test (Applicable as per relevant clause of latest version of NFC 33020)</li> </ul>
2	5.1.10.4	Suspension Assembly (SA)	<p>The following shall be Type Test for Suspension Assembly (SA)</p> <ul style="list-style-type: none"> <li>• Mechanical Test</li> <li>• Voltage Test</li> <li>• Climatic Aging Test</li> <li>• Corrosion Test</li> <li>• <b>Endurance Test under Thermal &amp; Mechanical Stresses.</b></li> </ul>	<p>The following shall be Type Test for Suspension Assembly (SA)</p> <ul style="list-style-type: none"> <li>• Mechanical Test</li> <li>• Voltage Test</li> <li>• Climatic Aging Test</li> <li>• Corrosion Test</li> <li>• <b>Endurance Test under Thermal &amp; Mechanical Stresses (optional till testing facilities are available in India)</b></li> </ul>
3	5.1.10.4	Anchoring Assemblies (AA)	<p>The following shall be Type Tests for Anchoring Assemblies (AA)</p> <ul style="list-style-type: none"> <li>• Mechanical Test</li> <li>• Voltage Test</li> <li>• <b>Dynamic Test</b></li> <li>• Climatic Aging Test</li> <li>• Corrosion Test</li> <li>• Endurance Test under Thermal &amp; Mechanical Stresses</li> </ul>	<p>The following shall be Type Tests for Anchoring Assemblies (AA)</p> <ul style="list-style-type: none"> <li>• Mechanical Test</li> <li>• Voltage Test</li> <li>• <b>Dynamic Test (Applicable for areas having sub zero minimum temperature)</b></li> <li>• Climatic Aging Test</li> <li>• Corrosion Test</li> <li>• Endurance Test under Thermal &amp; Mechanical Stresses</li> </ul>

SI No	Clause No. of SBD	Heading in clause	Provision as per Technical Specification of SBD	Amendments/ Recommendation
4	5.2	Anchoring Clamp for Insulated Messenger	<p>The clamps should be designed to Anchor LT-AB cable with insulated messenger. The clamp should consist of an Aluminium alloy corrosion resistant <b>castled</b> body, bail of stainless steel and self adjusting plastic wedges which shall anchor/hold the neutral messenger without damaging the insulation.</p> <ul style="list-style-type: none"> <li>• No losable part in the process of clamping arrangement</li> <li>• The clamp should conform to the standard NFC 33041 and 33042 or equivalent I.S. if any.</li> <li>• The clamp body should be made of corrosion resistant Aluminum alloy, bail should be of stainless steel and wedges should be weather and UV resistant polymer.</li> <li>• <b>Ultimate tensile strength of the clamp should not be less than 15 km for 50/70sq.mm insulated messenger wire / 10 KN for 25/35 sq.mm insulated messenger wire.</b></li> <li>• <b>Slip load of the clamp should not be less than 3 KN for 50/70 sq.mm. messenger wire / 2 KN for 25/35 sq.mm. messenger wire.</b></li> </ul>	<p>The clamps should be designed to Anchor LT-AB cable with insulated messenger. The clamp should consist of an Aluminum alloy corrosion resistant body, bail of stainless steel and self adjusting plastic wedges which shall anchor/hold the neutral messenger without damaging the insulation.</p> <ul style="list-style-type: none"> <li>• No losable part in the process of clamping arrangement</li> <li>• The clamp should conform to the standard NFC 33041 and 33042 or equivalent I.S. if any.</li> <li>• The clamp body should be made of corrosion resistant Aluminum alloy, bail should be of stainless steel and wedges should be weather and UV resistant polymer.</li> <li>• <b>Ultimate tensile strength of the clamp should be as per Table-6 of Technical Specification.</b></li> </ul>
5	5.3	Suspension Clamp for insulated neutral messenger	<p>The clamp should be designed to hang L.T – AB cable with insulated neutral messengers. The neutral messengers should be fixed by an adjustable grip device. A movable link should allow longitudinal and transversal movement of the clamp body.</p>	<p>The clamp should be designed to hang L.T – AB cable with insulated neutral messengers. The neutral messengers should be fixed by an adjustable grip device. A movable link should allow longitudinal and transversal movement of the clamp body.</p>



SI No	Clause No. of SBD	Heading in clause	Provision as per Technical Specification of SBD	Amendments/ Recommendation
			<ul style="list-style-type: none"> <li>• No losable part in the process of clamping arrangement.</li> <li>• The clamp should conform to the standard NFC 33040 or equivalent I.S, if any.</li> <li>• The clamp and the link made of Polymer should provide an additional insulation between the cable and the pole.</li> <li>• The clamps and movable links should be made of weather and UV resistant glass fibre reinforced polymer.</li> <li>• Clamps should be fixed with pole by eye hook / bracket. Bracket should be made of corrosion resistant aluminum alloy.</li> <li>• <b>Ultimate tensile strength of the clamp should not be less than 15 KN for 50/70 sq.mm. Insulated messenger wire 4.3 KN for 25/35 sq.mm. Insulated messenger wire.</b></li> <li>• <b>Maximum allowable load of the clamp should not be less than 20 KN for 50/70 sq.mm. insulated messenger wire/15 KN for 25/30 sq.mm insulated messenger wire.</b></li> </ul>	<ul style="list-style-type: none"> <li>• No losable part in the process of clamping arrangement.</li> <li>• The clamp should conform to the <b>latest version</b> of standard NFC 33040 or equivalent I.S, if any.</li> <li>• The clamp and the link made of Polymer should provide an additional insulation between the cable and the pole.</li> <li>• The clamps and movable links should be made of weather and UV resistant glass fibre reinforced polymer.</li> <li>• Clamps should be fixed with pole by eye hook / bracket. Bracket should be made of corrosion resistant aluminum alloy.</li> <li>• Ultimate tensile strength of the clamp should be as per Table-10 of Technical Specification.</li> </ul> <p style="text-align: right;">pg. 3</p>